

S9452

Coreless Motor High Torque Metal Gear

- **SPEED**
0.11 sec/60° at 6.0V
- **TORQUE**
9.2 kgf · cm at 6.0V
(127.8 ozf · in at 6.0V)
- **SIZE**
40 × 20 × 33.6 mm
(1.57 × 0.79 × 1.32 in)
- **WEIGHT**
50g (1.76 oz)

No dry battery use

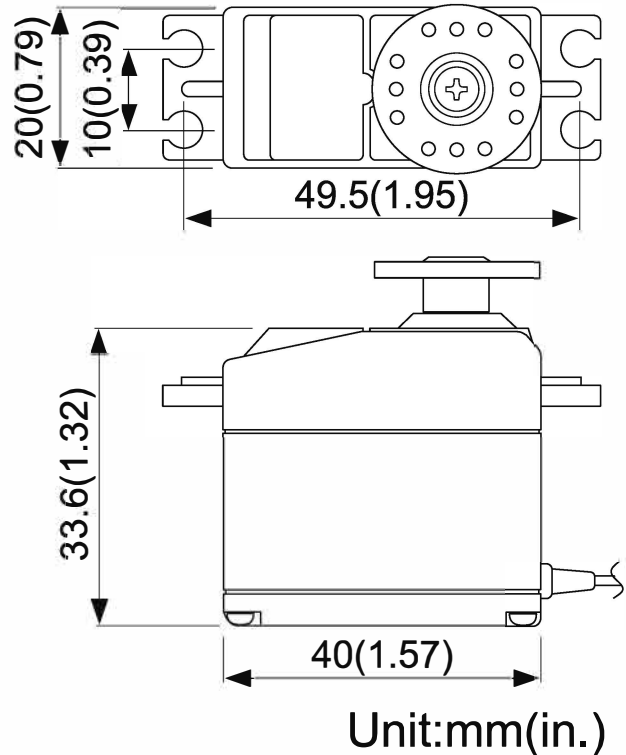

- Use the horn set screw supplied with the servo.
(Screw size: 3x8mm) The servo horn can be used the only 3mm in diameter of the hole center.

FUTABA CORPORATION

This product contains a chemical known to the State of California to cause cancer and birth defects (or other reproductive harm.)

Digital Servo Precautions

WARNING

 Do not leave the servo in the locked state. Leaving the servo in the locked state (state in which enough force is applied that the servo cannot move) may cause smoke, fire, and damage.

 Never connect the battery in reverse. Reverse connection may cause smoke, fire, and damage.

 Do not expose the servo to dust and water. The servo does not have a waterproof construction. If it gets wet, the servo may not operate or the power supply may short circuit.

 When installing the servo, check PUSHROD LINKAGE to make sure there is no binding in order to prevent excessive power consumption and decrease the life of the motor and battery.

CAUTION

 Do not touch the servo case immediately after servo operation. You may be burned because the motor and circuits inside the servo become hot.

 Do not turn the servo horn with unreasonable force. The servo may be damaged.

 Do not disassemble or modify the servo. The servo has a precision construction. Futaba Corp. will not be responsible for any disassembly or modification other than those specified by us.

 Use the servo as an actuator in hobby applications. Futaba will not be responsible if the servo is used in applications other than the above.

Futaba will not be responsible for damage, etc. caused by the use of parts other than Genuine Futaba parts.

- **Current consumption:** Digital servo is designed to be used with models which require especially high torque and high speed. For this reason, a large current flows during servo operation. Therefore, decide the safe number of uses by paying careful attention to the remaining battery capacity.
- **Power supply:** Use a battery or a voltage regulator with an ample margin as the power supply. The specified performance cannot be displayed with a dry cell battery. For HV servo, use a power supply of ratings 6.0V-7.4V. The specified performance cannot be displayed with a power supply of ratings 4.8V.
- **Applicable models:** Digital servo cannot be used with transmitters (servo neutral signal: 1310 μ s) manufactured before 1982.
- **System use:** For full performance of digital servos, please use them only with FM, PCM, HRS, and 2.4GHz systems. AM system is not recommended.