

12FG

12 CHANNEL RADIO CONTROL SYSTEM
PCMG3/PCM1024/FM selectable

INSTRUCTION MANUAL



Note: The battery in the T12FG transmitter is not connected to the battery connector at initial. Please connect the battery connector before use.



TABLE OF CONTENTS

INTRODUCTION	4	●Registration of the user's name	24
●Support and Service	4	●Home screen	25
●Application, Export, and Modification	5		
●Definitions of Symbols	6	FUNCTIONS OF SYSTEM MENU	27
●Safety Precautions (do not operate without reading)	6	Trainer.....	28
		Display.....	31
		System Timer	32
		User Name.....	33
		H/W Setting.....	34
		Information	35
BEFORE USE	9		
●Features of 12FG	9	MODEL BASIC SETTING PROCEDURE ...	36
●Contents and technical specifications	10	●Airplane/glider basic setting procedure.....	36
●Accessories.....	11	●Helicopter basic setting procedure.....	38
●Transmitter controls	12	●Receiver and servos connection.....	42
Cautions on handling antenna	12	●Servo connection by model type.....	43
LED monitor	13		
Switch (SA-SH).....	13	FUNCTIONS OF LINKAGE MENU	47
Volume (LD, RD).....	14	(Common Functions)	
Slide Lever (LS, RS).....	14	Linkage Menu functions table	47
Digital trim (T1-T6)	14	Servo Monitor.....	48
Edit key	15	Model Select.....	49
Stick Adjustment	16	Model Type.....	51
SD card.....	17	Frequency.....	54
Connector/Plug.....	18	Function	56
Installation and removal of the battery.....	19	Sub-Trim	58
RF module MZ-FM.....	19	Servo Reverse	59
●Receiver nomenclature	20	Fail Safe.....	60
●Safety precautions when installing receiver and servos	21	End Point	61
		Throttle Cut (Airplane/helicopter only).....	62
		Idle Down (Airplane/helicopter only).....	63
		Swash Ring (Helicopter only).....	64
		Swash (Helicopter only).....	65
		Timer	67
		T1-T6 SETTING	68
		Data Reset	69
		Condition Hold switching (Helicopter only)	70
BASIC OPERATION	22		
●Battery Charging	22		
How to charge the Ni-MH/Ni-Cd Battery....	22		
●How to turn On/OFF the transmitter	23		
When turning on	23		
When turning off.....	23		
Radio wave auto shut down.....	23		
●How to change the frequency/How to set the receiver's ID.....	23		
In case of using PCM-G3 receivers.....	23		
In case of using PCM1024, PPM receivers.....	24		

FUNCTIONS OF MODEL MENU	71	•Helicopter Functions	106
•Common Functions	71	Model Menu functions list	106
Servo Monitor (Linkage Menu 48)		PIT Curve/Pit trim	107
Condition Select.....	72	THR Curve/Throttle hover trim.....	110
AFR	74	Acceleration	112
Dual Rate	75	Throttle Hold	113
Program Mix.....	76	Swash Mix	114
•Airplane/Glider Functions	79	Throttle Mix.....	115
Model Menu functions list.....	79	PIT to Needle	116
AIL Differential	81	PIT to RUD (Revolution mix)	117
Flap Setting.....	82	Gyro (for GY type gyro)	118
AIL to Camber FLP	83	Governor	119
AIL to Brake FLP.....	84		
AIL to RUD.....	85	•Common Operations used in function setup	
Airbrake to ELE.....	86	screen	120
RUD to AIL.....	88		
Camber Mix.....	89		
ELE to Camber	91		
Camber FLP to ELE	92		
Butterfly	93		
Trim Mix 1/2	95		
Airbrake (Airplane only).....	97		
Gyro (for GYA type gyro).....	99		
V-tail	100		
Ailevator.....	101		
Winglet	102		
Motor	103		
RUD to ELE.....	104		
Snap Roll (Airplane only).....	105		

INTRODUCTION

Thank you for purchasing the Futaba® 12FG series digital proportional R/C system. In order for you to make the best use of your system and to fly safely, please read this manual carefully. If you have any difficulties while using your system, please consult the manual, our online Frequently Asked Questions (on the web pages referenced below), your hobby dealer, or the Futaba Service Center.

Due to unforeseen changes in production procedures, the information contained in this manual is subject to change without notice.

Support and Service: It is recommended to have your Futaba equipment serviced annually during your hobby's "off season" to ensure safe operation.

IN NORTH AMERICA

Please feel free to contact the Futaba Service Center for assistance in operation, use and programming. Please be sure to regularly visit the 12FG Frequently Asked Questions web site at <http://www.futaba-rc.com/faq/faq/index.html>. This page includes extensive programming, use, set up and safety information on the 12FG radio system and is updated regularly. Any technical updates and US manual corrections will be available on this web page. If you do not find the answers to your questions there, please see the end of our F.A.Q. area for information on contacting us via email for the most rapid and convenient response.

Don't have Internet access? Internet access is available at no charge at most public libraries, schools, and other public resources. We find internet support to be a fabulous reference for many modelers as items can be printed and saved for future reference, and can be accessed at any hour of the day, night, weekend or holiday. If you do not wish to access the internet for information, however, don't worry. Our support teams are available Monday through Friday 8-5 Central time to assist you.

FOR SERVICE ONLY

Futaba Service Center
3002 N. Apollo Drive, Suite 1
Champaign, IL 61822
Phone: 217-398-0007
service@futaba-rc.com

FOR SUPPORT

(PROGRAMMING AND USER QUESTIONS)

Please start here for answers to most questions:
www.futaba-rc.com
FACSIMILE: 217-398-7721
PHONE: 217-398-8970 option 2

OUTSIDE NORTH AMERICA

Please contact your Futaba importer in your region of the world to assist you with any questions, problems or service needs. Please recognize that all information in this manual, and all support availability, is based upon the systems sold in North America only. Products purchased elsewhere may vary. Always contact your region's support center for assistance.

Application, Export, and Modification

1. This product is suitable for model airplane, surface or 50 MHz (license required) use, if on the correct frequency. It is not intended for use in any application other than the control of models for hobby and recreational purposes. The product is subject to regulations of the FCC and is restricted under United States law to such purposes.

2. Exportation precautions:

(a) When this product is exported from the country of manufacture, its use is to be approved by the laws governing the country of destination which govern devices that emit radio frequencies. If this product is then re-exported to other countries, it may be subject to restrictions on such export. Prior approval of the appropriate government authorities may be required. If you have purchased this product from an exporter outside your own country and not the authorized Futaba distributor in your country, please contact the seller immediately to determine if such export regulations have been met.

(b) Use of this product with other than models may be restricted by Export and Trade Control Regulations, and an application for export approval must be submitted. In the US, use of 72MHz (aircraft only), 75MHz (ground models only) and 27MHz (both) frequency bands are strictly regulated by the FCC. This equipment must not be utilized to operate equipment other than radio controlled models. Similarly, other frequencies (except 50MHz, for HAM operators) must not be used to operate models.

3. Modification, adjustment, and replacement of parts: Futaba is not responsible for unauthorized modification, adjustment, and replacement of parts on this product. Any such changes may void the warranty.

The Following Statement Applies to the Receiver (for U.S.A.)

This device complies with part 15 of the FCC rules. Operation is subject to the following two conditions:

- (1) This device may not cause harmful interference.
- (2) This device must accept any interference received, including interference that may cause undesirable operation.



The RBRC™ SEAL on the nickel-cadmium battery contained in Futaba products indicates that Futaba Corporation of America is voluntarily participating in an industry-wide program to collect and recycle these batteries at the end of their useful lives, when taken out of service within the United States. The RBRC program provides a convenient alternative to placing used nickel-cadmium batteries into the trash or municipal waste system, which is illegal in most areas.

You may contact your local recycling center for information on where to return the spent battery. Please call 1-800-8-BATTERY for information on battery recycling in your area. Futaba Corporation of America's involvement in this program is part of its commitment to protecting our environment and conserving natural resources.

RBRC is a trademark of the Rechargeable Battery Recycling Corporation.

Definitions of Symbols

Pay special attention to safety where indicated by the following symbols.

 **DANGER** – Procedures which may lead to dangerous conditions and cause death/serious injury if not carried out properly.

 **WARNING** – Procedures which may lead to a dangerous condition or cause death or serious injury to the user if not carried out properly, or procedures where the probability of superficial injury or physical damage is high.

 **CAUTION** – Procedures where the possibility of serious injury to the user is small, but there is a danger of injury, or physical damage, if not carried out properly.

 = **Prohibited**

 = **Mandatory**

Warning: Always keep electrical components away from small children.

FLYING SAFETY

To ensure the safety of yourself and others, please observe the following precautions:

 **Have regular maintenance performed.** Although your 12FG protects the model memories with non-volatile EEPROM memory (which does not require periodic replacement) and not a battery, it still should have regular checkups. We recommend sending your system to the Futaba Service Center annually during your non-flying season for a complete checkup and service.

 **Use the *Fail-Safe* safety feature to set the throttle to *low-idle* in case of signal loss or RX battery failure.** Engine power will be automatically reduced to help limit personal or property damage. Refer to the **Failsafe Setting Procedure** listed in the index.

Receiver Ni-Cd Battery

 **Charge the batteries!** (See **Charging the batteries** listed in the index for details.) Always recharge the receiver batteries for at least 8 hours before each flying session. A low battery will soon die, causing loss of control and a crash. When you begin your flying session, reset your timer, and during the session pay attention to the duration of usage.

CAUTION: The **initial** charge on **new** NiCd receiver batteries should be done for 15 hours **using the slow-charger that came with the radio system**. This will “condition” the batteries so that the next charge may be done using the fast-charger of your choice. If the initial charge is done with a fast-charger the batteries may not reach their full capacity and you may be flying with batteries that are only partially charged.

Where to Fly

We recommend that you fly at a recognized model airplane flying field. You can find model clubs and fields by asking your nearest hobby dealer, or in the US by contacting the Academy of Model Aeronautics. You can also contact the national Academy of Model Aeronautics (AMA), which has more than 2,500 chartered clubs across the country. Through any one of them, instructor training programs and insured newcomer training are available. Contact the AMA at the address or toll-free phone number below.

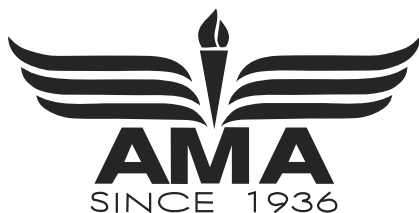

Academy of Model Aeronautics

5151 East Memorial Drive

Muncie, IN 47302-9252

Tel. (800) 435-9262

Fax (765) 741-0057

or via the Internet at <http://www.modelaircraft.org>

Ni-MH/Ni-Cd Battery Safety and Handling instructions

IMPORTANT!

Use only the **Futaba special charger** included with this set or other chargers approved by Futaba to charge the Ni-MH batteries in the 12FG transmitter and Ni-Cd batteries included with this set.

It is important to understand the operating characteristics of Ni-MH/Ni-Cd batteries. Always read the specifications printed on the label of your Ni-MH/Ni-Cd battery and charger prior to use. Failure to follow the proceeding precautions can quickly result in severe, permanent damage to the batteries and its surroundings and possibly result in a **FIRE!**

IMPORTANT PRECAUTIONS

- ⊘ Do not attempt to disassemble Ni-MH/Ni-Cd packs or cells.
- ⊘ Do not allow Ni-MH/Ni-Cd cells to come in contact with moisture or water at any time.
- ⚠ Always provide adequate ventilation around Ni-MH/Ni-Cd batteries during charge, discharge, while in use, and during storage.
- ⊘ Do not leave a Ni-MH/Ni-Cd battery unattended at any time while being charged or discharged.
- ⊘ Do not attempt to charge Ni-MH/Ni-Cd batteries with a charger that is NOT designed for Ni-MH/Ni-Cd batteries, as permanent damage to the battery and charger could result.
- ⚠ Always charge Ni-MH/Ni-Cd batteries in a fireproof location. Do not charge or discharge Ni-MH/Ni-Cd batteries on carpet, a cluttered workbench, near paper, plastic, vinyl, leather or wood, or inside an R/C model or full sized automobile! Monitor the charge area with a smoke or fire alarm.
- ⊘ Do not charge Ni-MH/Ni-Cd batteries at currents greater than the “1C” rating of the battery (“C” equals the rated capacity of the battery).
- ⊘ Do not allow Ni-MH/Ni-Cd cells to overheat at any time! Cells which reach greater than 140 degrees Fahrenheit (60°C) should be placed in a fireproof location.
- ⚠ Ni-MH/Ni-Cd cells will not charge fully when too cold or show full charge.
- ⚠ It is normal for the batteries to become warm during charging, but if the charger or battery becomes excessively hot disconnect the battery from the charger **immediately!!** Always inspect a battery which has previously overheated for potential damage, and do not re-use if you suspect it has been damaged in any way.
- ⊘ Do not use a Ni-MH/Ni-Cd battery if you suspect physical damage has occurred to the pack. Carefully inspect the battery for even the smallest of dents, cracks, splits, punctures or damage to the wiring and connectors. DO NOT allow the battery’s internal electrolyte to get into eyes or on skin—wash affected areas immediately if they come in contact with the electrolyte. If in doubt, place the battery in a fire-proof location for at least 30 minutes.
- ⊘ Do not store batteries near an open flame or heater.
- ⊘ Do not discharge Ni-MH/Ni-Cd batteries at currents which exceed the discharge current rating of the battery.
- ⚠ Always store Ni-MH/Ni-Cd cells/packs in a secure location away from children.

Secure Digital (SD) Memory Card Handling Instructions

(SD card is not included with this set)

- ⊘ Never remove the SD card or turn off power while entering data.
- ⊘ Never store the SD card where it may be subject to strong static electricity or magnetic fields.
- ⊘ Do not expose the SD card to direct sunlight, excessive humidity or corrosive environments.
- ⊘ Do not expose the SD card to dirt, moisture, water or fluids of any kind.
- ⚠ Always hold the SD card by the edges during installation and removal.
- ⚠ Be certain to insert the SD card in the correct direction.

AT THE FLYING FIELD

- ❗ **Always pay particular attention to the flying field's rules**, as well as the presence and location of spectators, the wind direction, and any obstacles on the field. Be very careful flying in areas near power lines, tall buildings, or communication facilities as there may be radio interference in their vicinity. If you must fly away from a club field, be sure there are no other modelers flying within a three-to-five-mile range, or you may lose control of your aircraft or cause someone else to lose control.
- ❗ **Before flying, be sure that the frequency you intend to fly with is not in use**, and secure any frequency control device (pin, tag, etc.) for that frequency before turning on your transmitter. It is never possible to fly two or more models on the same frequency at the same time. Even though there are different types of modulation (AM, FM, PCM), only one model may be flown on a single frequency at any one time.
- ❗ **Stop flying long before your batteries become low on charge**. Do not rely on your radio's low-battery warning systems, which are intended only as a precaution, to tell you when to recharge. **Always check your transmitter and receiver batteries prior to each flight.**
- ❗ To prevent possible damage to your radio gear, turn the power switches on and off in the proper sequence:
 1. Set the throttle stick to the idle position, or otherwise disarm your motor/engine.
 2. Fully extend the transmitter antenna.
 3. Turn on the transmitter power and allow your transmitter to reach its home screen.
 4. Confirm the proper model memory has been selected.
 5. Turn on your receiver power.
 6. Test all controls. If a servo operates abnormally, don't attempt to fly until you determine the cause of the problem. (For PCM systems only: Test to ensure that the Failsafe settings are correct by waiting at least 2 minutes after adjusting. Then, turn the transmitter off and confirm the proper surface/throttle movements. Turn the transmitter back on.)
 7. Start your engine.
 8. Complete a full range check.
 9. After flying, bring your throttle stick to idle position, engage any kill switches or otherwise disarm your motor/engine.
 10. Turn off receiver power.
 11. Turn off transmitter power.

If you do not turn on your system in this order, you may damage your servos or control surfaces, flood your engine, or in the case of electric-powered or gasoline-powered models, the engine may unexpectedly turn on and cause a severe injury.

- ❗ **While you are getting ready to fly, if you place your transmitter on the ground, be sure that the wind won't tip it over**. If it is knocked over, the throttle stick may be accidentally moved, causing the engine to speed up. Also, damage to your transmitter may occur.
- ❗ **Before taxiing, be sure to extend the transmitter antenna to its full length**. A collapsed antenna will reduce your flying range and cause a loss of control. It is a good idea to avoid pointing the transmitter antenna directly at the model, since the signal is weakest in that direction.
- ⊘ **Don't fly in the rain!** Water or moisture may enter the transmitter through the antenna or stick openings and cause erratic operation or loss of control. If you must fly in wet weather during a contest, be sure to cover your transmitter with a waterproof barrier. Never fly if lightning is expected.
- ⊘ **Never turn the transmitter off during flight!** Switching the transmitter off and on during flight will very likely cause a crash because of the time required for the transmitter to "reboot" and become fully functional.

BEFORE USE

Features

PCMG3 (PCM Generation 3)

PCMG3 has a 40% faster response than current PCM1024. The resolution is 2048, which is double the current PCM1024. It can operate up to 12 linear channels and 2 switch channels. The multi-level modulation technology has been implemented for the R/C industry to achieve the highest performance available today.

WFSS (Wireless Frequency Setting System)

Both transmitter (T12FG) and receiver (R5114) are frequency synthesizer systems.

Model types

Seven types of main wings and three types of tail wings are available for airplanes. Eight swash types are available for helicopters. Seven types of main wings and three types of tail wings are available for gliders. Functions and mixing functions necessary for each model type are set in advance at the factory.

Mixing functions

The T12FG transmitter continues the functions of the higher class model T14MZ/T12Z.

Data input

Large graphic LCD and new type edit keys substantially improve ease of setup.

Stick

Each axis is supported by dual ball bearings. This allows for finer and more precise operation. The new potentiometers also offer longer life.

Ni-MH battery

T12FG is operated by a 7.2V/1,700 mAh Nickel-Metal Hydride battery.

R5114DPS

The R5114DPS is a small 14CH synthesized receiver with high sensitivity and selectability.

SD card (Secure Digital memory card) (Not included)

Model data can be saved in a SD card (32MB-1GB.) When T12FG transmitter software updating files are released, the software can be updated by using a SD card.

Contents and Technical Specifications

(Specifications and ratings are subject to change without notice.)

Your 12FGA/12FGH/12FG includes the following components:

The set contents depend on the type of set.

- T12FG Transmitter, including RF module (MZ-DDS)
- R5114 Receiver
- HT2F1700B Ni-MH battery, NR4F1500 Ni-Cd battery & Charger
- Switch harness
- Hex Wrench (1.5mm, 2.5mm)
- Neck strap

Transmitter T12FGA/T12FGH/T12FG

Operating system: 2-stick, 12+2 channels, PCM-G3, synthesizer system

Transmitting frequency: 29, 35, 36, 40, 41, or 72 MHz bands

Modulation: PCM-G3, PCM1024, or FM/PPM switchable.

Power supply: 7.2V HT6F1700B Ni-MH battery

Current drain: 500mA average

Receiver R5114DPS

(PCM-G3, Synthesizer, Dual conversion)

Receiving frequency: 29, 35, 36, 40, 41, or 72 MHz bands

Intermediate freq.: 10.7 MHz & 450 kHz

Power requirement: 4.8 V Ni-Cd battery

Current drain: 75 mA

Size: 37.7x52.3x16 mm (1.48x2.06x0.63 in.)

Weight: 32.5 g (1.15 oz.)

Channels: 14

Suggested Servos for use with your 12FG

Servo S9252 (Digital servo)

Control system: Pulse width control, 1.52 ms neutral

Power requirement: 4.8 V (from receiver)

Output torque: 6.6 kg-cm (91.7 oz.-in.) at 4.8V

Operating speed: 0.14 sec/60 at 4.8V

Size: 40.0 x 20.0 x 36.6 mm (1.57 x 0.79 x 1.44 in.)

Weight: 50 g (1.76 oz.)

Servo S9255 (Digital servo)

Control system: Pulse width control, 1.52 ms neutral

Power requirement: 4.8 V (from receiver)

Output torque: 9.0 kg-cm (125.0 oz.-in.) at 4.8V

Operating speed: 0.16 sec/60 at 4.8V

Size: 40.0 x 20.0 x 36.6 mm (1.57 x 0.79 x 1.44 in.)

Weight: 55 g (1.94 oz.)

The following additional accessories are available from your dealer. Refer to a Futaba catalog for more information:

- HT6F1700B Transmitter battery pack - the (1700mAh) transmitter Ni-MH battery pack may be easily exchanged with a fresh one to provide enough capacity for extended flying sessions.
- Trainer cord - the optional training cord may be used to help a beginning pilot learn to fly easily by placing the instructor on a separate transmitter. Note that the T12FG transmitter may be connected to another T12FG system, as well as to any other models of Futaba transmitters. The T12FG transmitter uses one of the three cord plug types according to the transmitter connected. (Refer to the description at the TRAINER function instructions)
- Neckstrap - a neckstrap may be connected to your T12FG system to make it easier to handle and improve your flying precision since your hands won't need to support the transmitter's weight.
- Y-harnesses, servo extensions, etc - Genuine Futaba extensions and Y-harnesses, including a heavy-duty version with heavier wire, are available to aid in your larger model and other installations.
- Gyros - a variety of genuine Futaba gyros is available for your aircraft or helicopter needs.
- Governor (GV1) - for helicopter use. Automatically adjusts throttle servo position to maintain a constant head speed regardless of blade pitch, load, weather, etc.
- DSC Cord - allows setup and testing without transmitting. With your Transmitter and Receiver off, plug cord into trainer port and then, into the receiver Battery/DSC (B/C) slot. All programming and setup may be done in this manner without transmitting.
- Receivers - various models of Futaba receivers may be purchased for use in other models. (Receivers for PCM-G3, PCM1024, or FM/PPM types are available.)
- Optional Charger - Futaba CR-2000 Ni-MH/Ni-Cd Transmitter/Receiver Battery Charger.

Transmitter controls

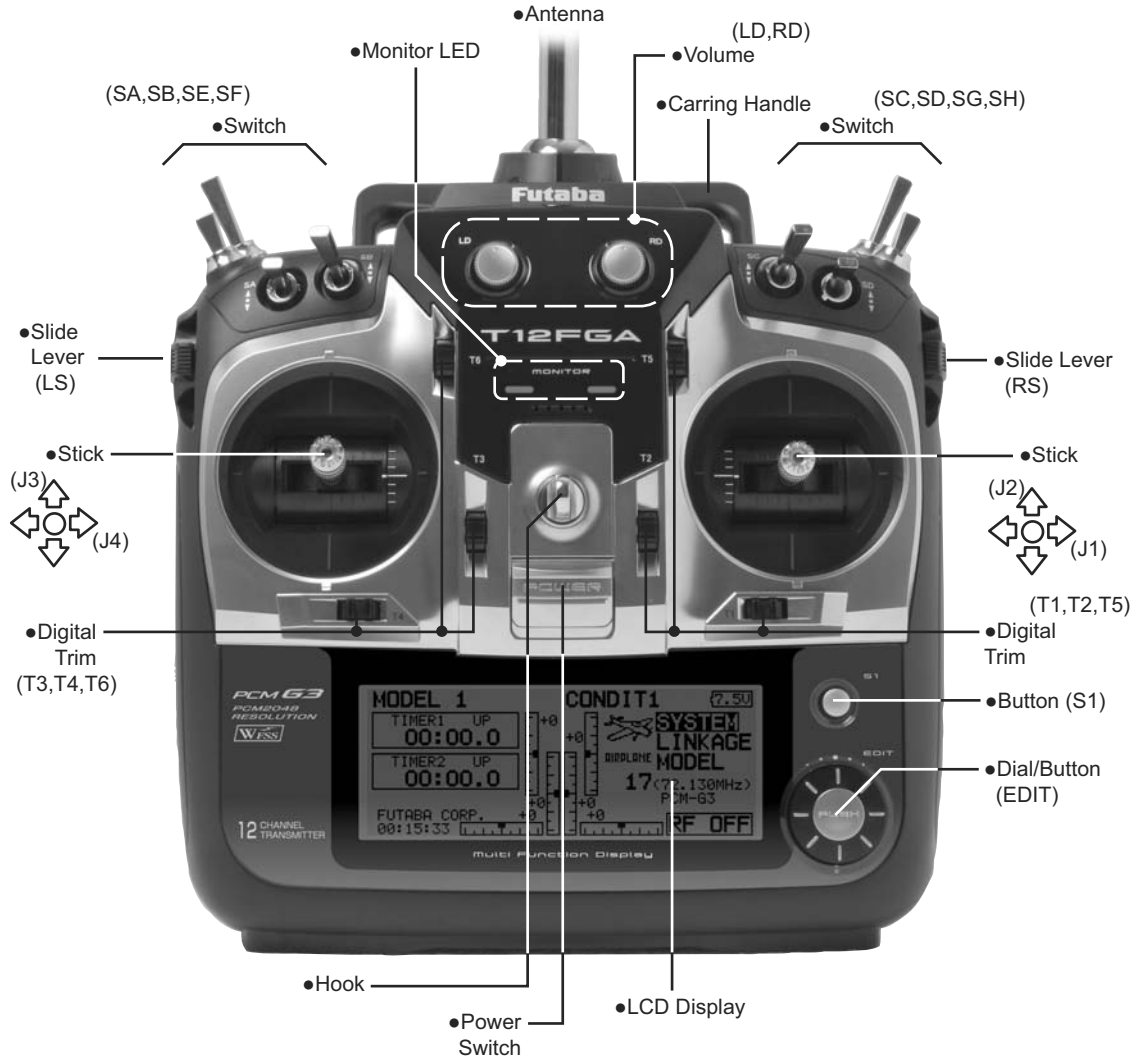

Cautions on handling antenna

⚠ WARNING

! Be sure to attach the antenna before operation.

*Antenna is stored in the antenna storage compartment in the transmitter.

! Extend the antenna to the full extent, and make sure that the antenna is securely locked before operation.

⊘ Never hold the antenna alone.

*Hold the carrying bar, otherwise the main body can be damaged.

•Removing and storing the antenna

To remove the antenna from the storage compartment, grasp the end of the antenna and pull it out.

To store the antenna, push it in until it is locked.

If the antenna is not pushed in all the way, it may fall out.

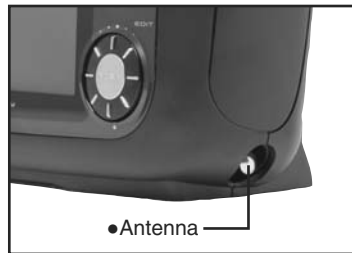

•Mounting and dismounting the antenna

Mount the antenna by turning it clockwise until it locks in place.

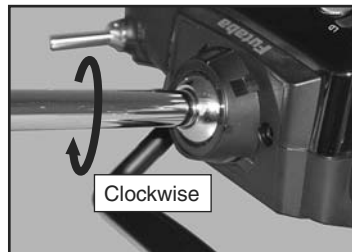

When dismantling the antenna, turn the antenna counterclockwise.

•Angle adjustment of the antenna

You can change the angle of the antenna, as you like. Use a 2.5mm hexagonal wrench to turn counterclockwise to release the screw on the left of the antenna holder, and change the angle of the antenna, as you like. Then retighten.

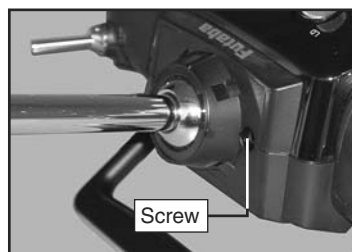

Monitor LED display

The status of the transmitter is displayed by LED at the bottom left and right sides of the "T12FG" logo.

LED (Red)

Displays the status of the RF module.

- Blink
When the RF module is not connected, an RF module of a frequency different from the transmitter setting is used, or the RF module is abnormal, the LED blinks.
- On
The LED lights steadily when the proper RF module is connected.

Displays the "non-default condition" warning.

- Blink
Power switch is turned on when any condition switch is in the ON state.

LED (Green)

Displays the state of transmission of radio waves.

- Off
Radio waves are in the OFF state.
- On
Radio waves are being transmitted.
- Slow blink
Trainer function is set to the student mode (radio waves OFF).

Switch (SA-SH)

(Switch Type)

- SA : 3 positions; Alternate; Short lever
- SB : 3 positions; Alternate; Long lever
- SC : 3 positions; Alternate; Long lever
- SD : 3 positions; Alternate; Short lever
- SE : 3 positions; Alternate; Short lever
- SF : 2 positions; Alternate; Long lever
- SG : 3 positions; Alternate; Short lever
- SH : 2 positions; Momentary; Long lever

*You can choose switch and set the ON/OFF-direction in the setting screen of the mixing functions.

Volume



To change the trim rate, you must activate this through the function menu, within the linkage menu. Use the EDIT dial to select the trim box and then push the EDIT button and you will access another screen which enables you to change the trim percentages.

Note: The trim positions you have set will be stored in the non-volatile memory and will remain there.

Volume LD and RD:

The volume LD and RD are analog type.

*T12FG beeps when the volume knob reaches center.

*You can use each setting screen of the mixing functions to select volumes and define the direction of a movement.

Slide Lever

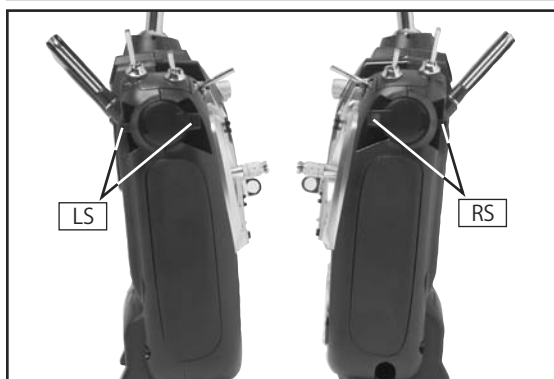

LS (Left), RS (right):

The slide lever LS and RS are analog type.

*T12Z beeps when the lever comes to the center.

*You can select a slide lever and set the movement direction on the setting screen of mixing functions.

Digital Trim



This transmitter is equipped with six digital trims. Each time you press a trim button, the trim position moves one step. If you continue pressing it, the trim position starts to move faster. In addition, when the trim position returns to the center, the tone will change. You can always monitor trim positions by graphics on the screen.

Edit keys operation

Data input operation is performed using the EDIT dial/EDIT button, and S1 button.

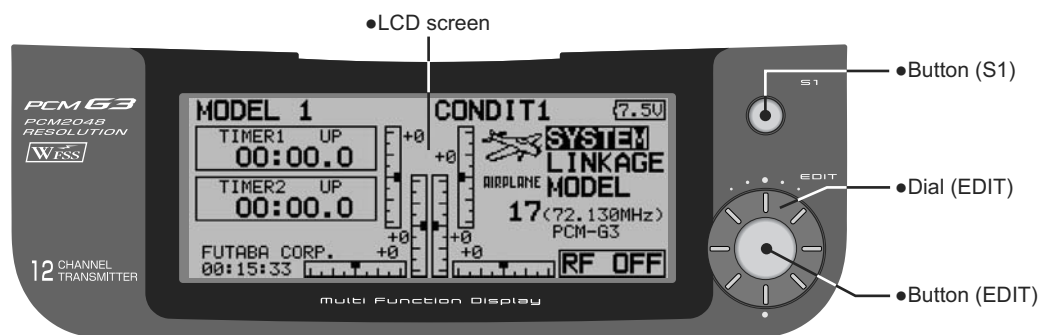

LCD screen:

The LCD screen contrast can be adjusted by using the system menu screen setting [DISPLAY].

EDIT dial:

Movement of the cursor on the menu screen and movement of the cursor among items on a setup screen can be controlled by turning the EDIT dial to the left and right. You can also go to the next page, if there is a next page.

At data input, value input, mode selection, and similar operations can be performed by turning the EDIT dial to the left and right. (Value, ON, OFF, INH, ACT, etc.)

EDIT button:

Push the EDIT button when you want to open a setup screen or to switch between cursor move mode (reverse display) and data input mode (box display).

This button can also be used as the EDIT button when a confirmation message is displayed on the screen, etc.

S1 button:

When there is a next page on a menu screen or setup screen, you can go to that page by pushing the S1 button. In this case, the cursor moves to the screen title item (excluding a part of function.)

Exiting setup screen:

To end operation on a setup screen and return to the menu screen, move the cursor to the screen title item and push the EDIT button.

To return to home screen directly, push the S1 button for 1 second.

Also move the cursor to the screen title item and push the EDIT button to return to the home screen from a menu screen.

Stick Adjustment

Adjustment of the stick lever length

You can adjust the length of stick levers, as you like. It is recommended to adjust the length of the sticks in line with your hand size.

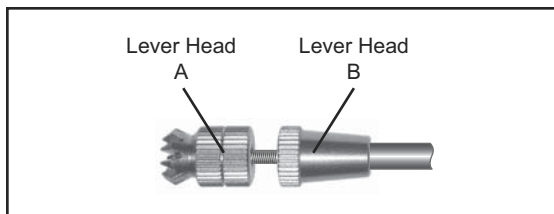

1. Hold the lever head "B" and turn the lever head "A" counter-clockwise. The lock will be released.
2. Turn the lever-head "A" clockwise as you hold the lever-head "B" after placing it as you like.

Adjustment of stick lever tension

The tension of the self-return type stick lever can be adjusted.

1. Remove the rubber grip on the back of the transmitter.

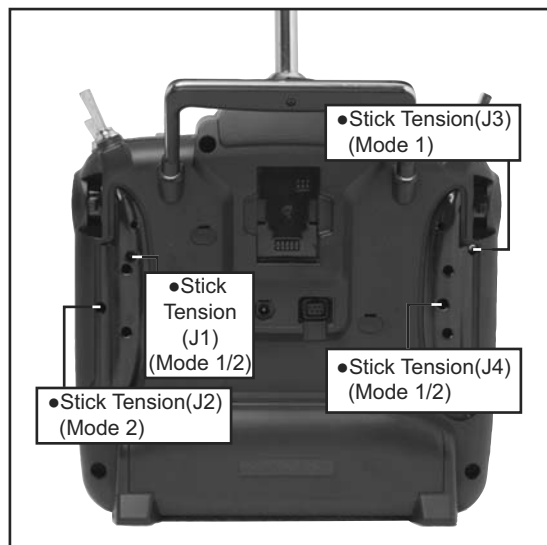

2. Use the accessory 1.5mm hexagonal wrench to adjust the spring strength as you prefer by turning the adjusting screw of the stick you want to adjust.

*Turning the screw clockwise increases the tension.

CAUTION: If you loosen the screw too much, the stick may not operate because it is caught internally.

- 3) At the end of adjustment, re-install the rubber grip.

Adjustment of Throttle Stick (Ratchet System)

You can also choose either airplane ratchet system or helicopter-touch.

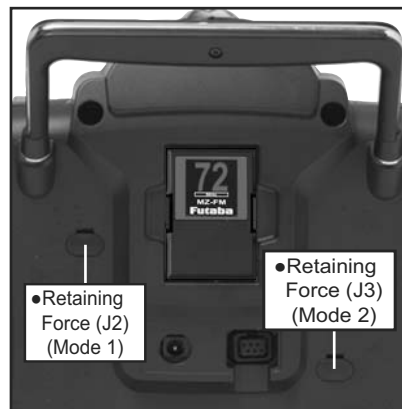

1. Open the dust protection cap on the back of the transmitter that is covering the hole for throttle stick adjustment.
2. Use the attached 1.5mm hexagonal wrench to turn the adjustment screw and set it as you prefer. Turning the screw clockwise increases the tension.

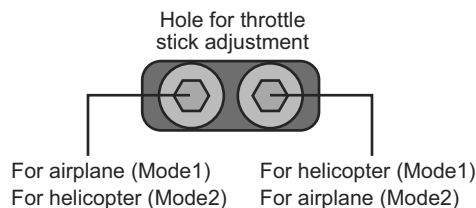

*This transmitter has two ratchet plates, one for airplane and the other one for helicopter. If you tighten both screws, you won't be able to achieve the adjustment that you need because of the overlap of those two adjustments.

*If you want to change the setting from airplane to helicopter (or from helicopter to airplane), turn counterclockwise until the throttle stick moves freely. Then turn the screw for the helicopter (or airplane) until you get the tension you like.

SD Card (Secure Digital memory card) (Not included)

The T12FG transmitter model data can be stored by using any SD card on the market. When T12FG transmitter update software is released, the software is updated using an SD card. (SD card memory size: 32MB to 1GB)

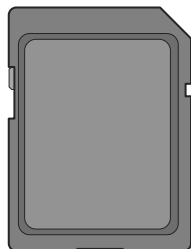

⚠ Caution

- !** Be sure to turn off the power to the transmitter before inserting or removing the SD card.
- ⊘** As the SD card is a precision device, do not use excessive force when inserting.

Restrictions when using an SD card

The following restrictions apply when using an SD card:

- *It may first be necessary to initialize the SD card in T12FG dedicated format. The SD card cannot be used as is immediately after purchase.
- *Initializing destroys all the data previously saved on the card.
- *An SD card formatted by the T12FG cannot be written directly from a PC by Explorer, etc. The files must be converted and written by special conversion software. Files are identified by number instead of name. (The special conversion software can be downloaded from Futaba dealer web site.)

Inserting/removing the SD card

1. Turn off the transmitter power and then open the battery cover at the rear of the transmitter.
- 2.

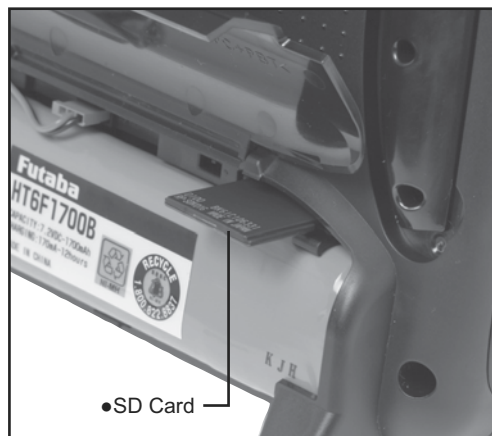

[Inserting the card]

Turn the SD card so that the front of the card faces the bottom of the transmitter and slide the card into the card slot.

*Push in the card until it is locked.

[Removing the card]

When the SD card is pushed, it is pushed out and can be removed.

3. Close the battery cover.

SD card initialization

To use an SD card with the T12FG, the card must first be formatted. Once formatted, the card does not have to be reformatted. Formatting is performed by the T12FG.

[IMPORTANT] When an SD card is formatted, all the existing data is destroyed. Do not format a card containing important data.

[Formatting procedure]

1. Insert the SD card into the SD card slot of the T12FG.
2. Turn on the T12FG power. When an unformatted card is inserted into the T12FG, the screen shown below appears.

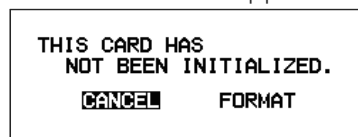

3. If the T12FG is ready to format, move the cursor to [FORMAT] and push the EDIT button. (To cancel formatting, move the cursor to [CANCEL] and push the EDIT button.)

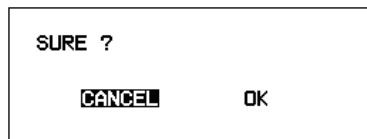

*Formatting starts. During formatting, the rectangular mark at the center of the screen moves.

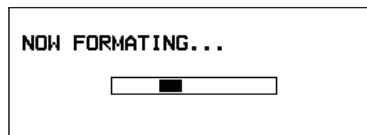

*When formatting is completed, a message is displayed. Depending on the card capacity and speed, formatting may take from tens of seconds to several minutes.

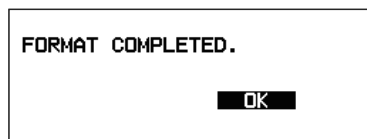

[IMPORTANT] Do not turn off the power until the [FORMAT COMPLETED] message is displayed.

4.End formatting by pushing the EDIT key.

SD card reader/writer

Saving model data and update files (released from Futaba) into the SD card, you can use those files on your T12FG transmitter. Equipment for reading and writing SD cards is available at most electronics stores.

Stored data

When you have a problem of saving or reading data after a long period of use, please get a new SD card.

*We do not have the responsibility of compensating any failure or damage to the data stored in the memory card no matter what the reason is. Be sure to keep a backup of your important data in your SD card.

Connector/Plug

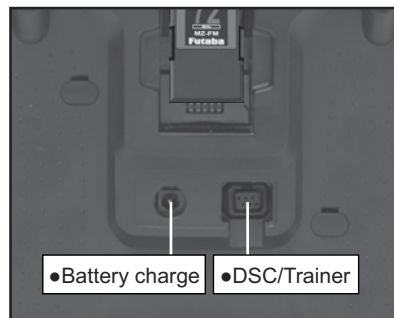

Connector for trainer function

When you use the trainer function, connect the optional trainer cable between the transmitters for teacher and student.

*You can set the trainer function on the Trainer Function screen in the system menu.

Connector for DSC function

You can operate the transmitter without transmitting radio waves by connecting the transmitter and the receiver to the DSC cable.

*Please refer to the section "Connection between Receiver/Servo"

Connector for battery charger

This is the connector for charging the Ni-MH battery HT6F1700B that is installed in the transmitter. Do not use any other chargers except the attached special charger corresponding to Ni-MH battery.

⚠ Danger

⊘ Do not connect any other chargers except the special charger to this charging connector.

*If you take out the Ni-MH battery HT6F1700B from the transmitter, you can use the optional quick charger CR-2000 corresponding to Ni-MH battery.

Installation and Removal of the HT6F1700B Transmitter Battery

Attachment of the battery

1. Open the battery cover on the rear of the transmitter toward upper side.

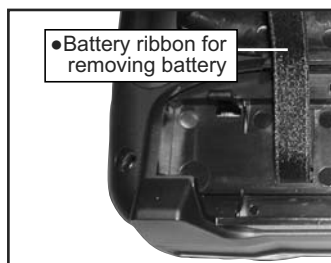

2. Install the battery in the holder.

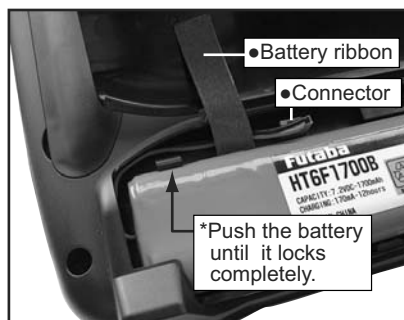

3. Connect the battery connector.
4. Close and lock the battery cover completely.

Battery Removal

Note: If you remove the battery while the power is on, the data you have set will not be saved.

1. Open the battery cover on the rear of the transmitter toward upper side.
2. Disconnect the battery connector.
3. Pull up the battery ribbon to release the lock.
4. Remove the battery.
5. Close and lock the battery cover completely.

⚠ Warning

⚠ Be careful not to drop the battery.

⊘ Never disconnect the battery connector from the T12FG transmitter while some message are displayed on the screen after turning off the power.

* Internal devices such as memories may be damaged.

* If there is any problem, the message "Backup Error" will be shown the next time when you turn on the power of the transmitter. Do not use the transmitter as it is. Send it to the Futaba Service Center.

RF module MZ-FM

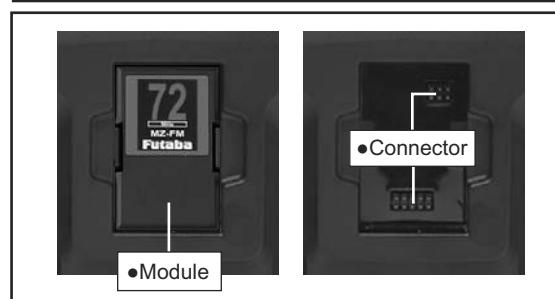

⚠ Caution

⚠ Be sure to turn off the power of the transmitter before you attach or detach the module.

Detachment of the RF module

Pull the module straight while you are pushing inward on the projections on both sides of the module.

*There is a connector above and under the module respectively. So you might find it difficult to pull out the module if the module is tilted.

Attachment of the RF module

Insert the module with care so that the connector pins of the transmitter won't be bent.

Receiver nomenclature

Before using the receiver, be sure to read the precautions listed in the following pages.

Receiver R5114DPS

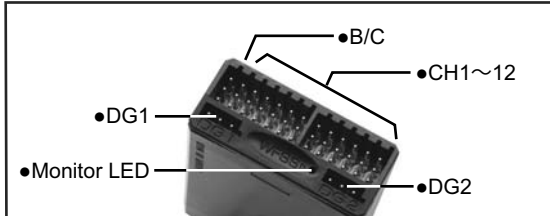
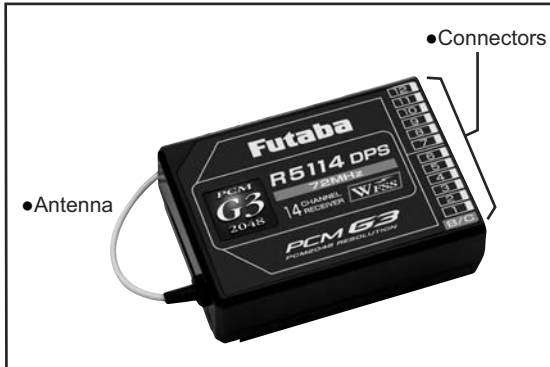

Connector

"1 through 12": outputs for the channels 1 through 12

"DG1", "DG2": outputs of DG1 and DG2 channels

"B/C": connector for the power and DSC.

LED Monitor

This monitor is used when changing the frequency of the receiver.

Safety precautions when you install receiver and servos

⚠ Warning

Connecting connectors

- ❗ Be sure to insert the connector until it stops at the deepest point.

How to protect the receiver from vibration and water

- ❗ Wrap the receiver with something soft such as foam rubber to avoid vibration. If there is a chance of getting wet, put the receiver in a waterproof bag or balloon to avoid water.

Receiver's antenna

- ⊘ Never cut the receiver's antenna. Do not bind the receiver's antenna with the cables for servos.

- ❗ Locate the receiver's antenna as far as possible from metals or carbon fiber components such as frames, cables, etc.

*Cutting or binding the receiver's antenna will reduce the radio reception sensitivity and range, and may cause a crash.

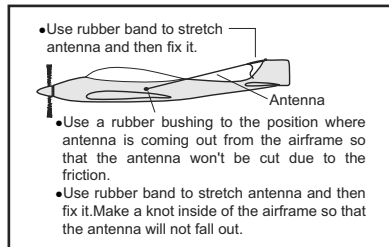

*Use rubber grommet or silicon tube to protect the antenna from being cut or from its insulation peeling off at the fuselage antenna-exit hole.

*Place the receiver antenna out from the fuselage part to the nonmetal tube installed in skid etc. Please keep antenna away from parts made of metal and carbon graphite.

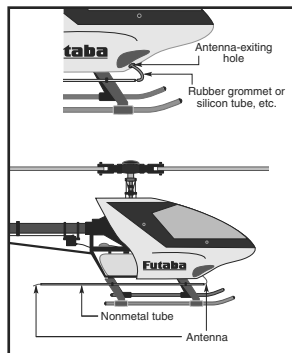

Servo throw

- ❗ Adjust your system so that pushrods will not bind or sag when operating the servos to the full extent.

*If excessive force is continuously applied to a servo, your aircraft may crash because the servo would be damaged and the battery would be consumed rapidly.

Mounting servos

- ❗ Use a vibration-proof rubber (such as rubber grommet) under a servo when mounting the servo on a servo mount. And be sure that the servo cases do not touch directly to the metal parts such as servo mount.

*If a servo case is contacting directly to the airframe, the vibration of the airframe directly travels to and may damage the servo.

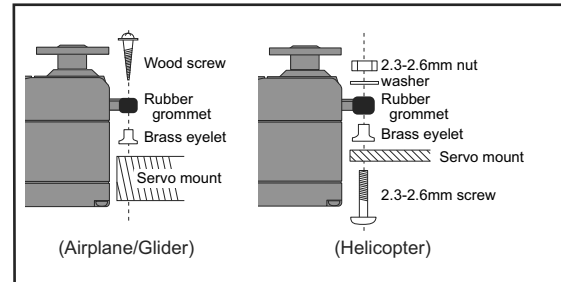

Servo lead wires

To prevent the servo lead wires from being broken by vibration during flight, provide a margin so that the wire sticks out slightly and fasten it at suitable points. In addition, periodically check the wire during daily maintenance

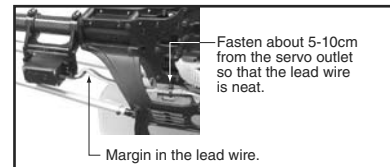

Mounting the power switch

When mounting a power switch to an airframe, make a rectangular hole that is a little larger than the total stroke of the switch so that you can turn the switch ON/OFF without binding.

Avoid mounting the switch where it can be covered by engine oil and dust. In general, it is recommended to mount the power switch on the side of the fuselage that is opposite the muffler.

BASIC OPERATION

Battery Charging

Before charging batteries, read the "Cautions for handling battery and battery charger" in the section "Ni-MH/Ni-Cd Battery Safety and Handling Instructions".

How to charge the Ni-MH battery HT6F1700B for the transmitter and the Ni-Cd battery NR4F1500 for the receiver

⚠ Danger

⊘ The Ni-MH battery HT6F1700B is only for your T12FG. Do not use this battery for other equipment.

! Be sure to use the attached special charger to charge the battery.

*If you take out the Ni-MH battery HT6F1700B from the transmitter, you can use the optional quick charger CR-2000 corresponding to Ni-MH battery.

*Battery charging will not automatically stop. Remove the battery and transmitter from the charger and remove the charger from the wall socket.

*It is recommended to reactivate the battery by cycling several times if the battery has not been used for a long period.

*In case of Ni-MH/NiCd battery, you may find the poor performance of the battery if you have used the battery only for a short period or if you repeat charging while the battery is not fully discharged. It is recommended to discharge the battery to the recommended level after your usage. It is also recommended to charge the battery just before your usage.

[Method of charging battery]

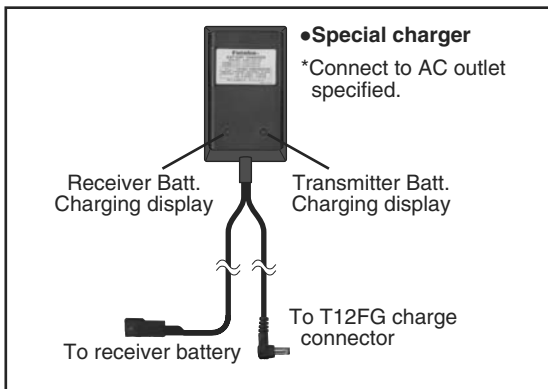

1. Connect the special charger to the wall socket (AC outlet).
2. Connect the connectors to the NR4F1500 NiCd battery and/or T12FG charging connector.

*Confirm that each charging indicator, LED lamp, is on.

*Turn off the transmitter while charging the battery.

3. Remove the battery after 15 hours.

How to turn transmitter power ON/OFF

For safety reasons, the radio will be emitting only after confirming when turning on the power. Please follow the instructions for turning on/off the transmitter.

When turning on the power of the transmitter

1. Turn on the power switch of the transmitter.

*After initialization of the transmitter is over, the frequency confirmation screen pops up, and the red LED monitor turns on.

MODEL 1	CONDIT1	(7.50)
BAND No. 17 (72.130MHz)	AMERICA	PCM-G3
PLEASE CHECK FREQUENCY. TRANSMIT ? YES NO		

2. Check the frequency shown on the screen. If it is OK, then select [YES] and push the EDIT button.

*The green LED monitor turns on and the transmitter begins to emit radio waves.

*To not transmit, select [NO] and push EDIT button.

3. Then, you will see the home screen and you will be able to set conditions.

How to stop the transmitter

Turn off the power switch of the transmitter. The internal circuit of the transmitter starts the shut down process including saving the set-up data.

Warning

- ⊘ Once you turn off the power, never operate the power switch until the power shutdown process is fully completed. If you turn on the power switch again while the transmitter is still in the process of power shutdown, the transmitter power does not start.

Radio wave auto shut-down

If you do not operate the transmitter (stick, knob, switch or digital trim) for 30 minutes, the radio wave is stopped, and the message "PLEASE TURN OFF POWER SWITCH" is displayed with the alarm sound.

1. Turn off the transmitter power and turn on it again

How to change the frequency/How to set ID

The T12FG system has employed the frequency synthesizer scheme. The T12FG transmitter will set the frequency of the R5114DPS (PCMG3 receiver) by the wireless data transmission. When you are using a new PCMG3 receiver and changing the frequency, set ID or frequency using the following instructions.

Note: Receiver ID setting is not performed at the time of purchase. Always perform the following receiver ID setting before use.

*The frequency cannot be changed if the receiver ID and transmitter settings are different.

In case of using PCMG3 receivers

*Make sure that PCM-G3 is set as a modulation scheme. Then change the frequency by the following instruction.

*For a description of the modulation scheme change, refer to the FREQUENCY function, p.54.

Frequency setup screen

1. Turn on the transmitter power. A confirmation message ("TRANSMIT?") is displayed. Since you do not want to transmit, select [NO] and then push the EDIT button.
2. Select the area that displays the frequency on the home screen or [FREQUENCY] in the linkage menu and push the EDIT button.

*The frequency setup screen appears.

FREQUENCY	(7.50) 1/1
BAND No. (FREQ. CH)	17 (72.130MHz)
FREQ. BAND / AREA	72MHz AMERICA
MODULATION	PCM-G3 (MODE A (5K))
RECEIVER ID RX1	00001001
RECEIVER ID RX2	NO USE

How to set ID

1. Select [RECEIVER ID](RX1) and push the EDIT button.

*The receiver ID code input screen appears.

2. Input the 8-digit ID code stuck to the receiver case. If the inputted ID code is correct, select [ENTER] and then push the EDIT button.

*Select the figure with the EDIT dial and push the EDIT button for each digit.

*Use [BACK-SPACE] to move back digit by digit for correction if you made a mistake. When you want to stop ID code change, move to the function name at the top of the screen and push the EDIT button to return to the original screen.

*Once the receiver ID code is set, it does not have to be reset as long as the receiver is not changed.

*When you use two receivers with a large aircraft, input the ID of each receiver.

How to change the frequency

1. When switching the frequency, select [BAND NO.] and push the EDIT button.

- *The frequencies which can be selected appear on the screen.
2. Select the frequency you want to use and push the EDIT button.
 - *A confirmation message appears.
 - *When changing the frequency band, change the module before turning on the power.
 3. If the frequency is correct, push the EDIT button.
 - *A screen which shows that frequency data is being sent is displayed and the frequency data is sent to the receiver together with a beep sound. (The frequency data can be resent by selecting [RETRY] and pushing the EDIT button.)
 4. Turn on the receiver power while the new frequency data above is displayed.
 - *When receiver frequency setting is complete, the receiver monitor LED blinks once and the CH1 servo shuttles 3 times across the neutral position.
 - *The new receiver frequency data uses very low power whose frequency is different from that of the frequency channel used. When setting the receiver frequency, bring the transmitter and receiver as close together as possible.
 - *If the new data is not read correctly due to the ambient conditions, extend the transmitter antenna and bring the transmitter close to the receiver antenna and repeat steps 3 through 4.
 - *The frequency can also be changed by connecting the transmitter and receiver directly with the DSC cord and performing steps 3 through 4.
 - *When the receiver ID code is incorrect, the receiver monitor LED will blink. Return to the receiver ID setup screen and reset the receiver ID.
 5. When frequency setting is complete, move the cursor to the [END] position and push the EDIT button.

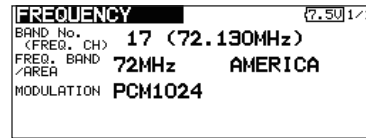

How to change the frequency

3. When switching the frequency, select [BAND NO.] and push the EDIT button.
 - *The frequencies which can be selected appear on the screen.
4. Select the frequency corresponding to your receiver and push the EDIT button.
 - *A confirmation message appears.
5. If the frequency is correct, push the EDIT button.
6. A confirmation message ("TRANSMIT?") is displayed. To send on the new frequency, select [YES] and push the EDIT button.
 - *To not send, select [NO] and push the EDIT button.

Registration of the user's name

T12FG transmitter can register user's name.

User's name setup screen

1. Turn on the power of the transmitter.
2. Select [USER NAME] in the system menu and push the EDIT button.
 - *The user name set up screen appears.

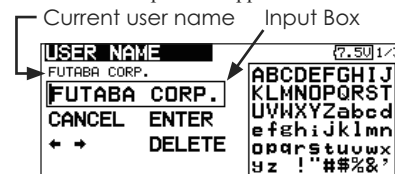

In case of using PCM1024, PPM receivers

- *Make sure that PCM1024 or PPM is set as a modulation scheme. Then change the frequency as follows.
- *For a description of the modulation scheme change, refer to the FREQUENCY function, p.54.

Frequency setup screen

1. Turn on the transmitter power. A confirmation message ("TRANSMIT?") is displayed. Since you do not want to transmit, select [NO] and then push the EDIT button.
2. Select the area that displays the frequency on the home screen or [FREQUENCY] in the linkage menu and push the EDIT button.
 - *The frequency setup screen appears.

Changing the user name

1. Change the user name as described below:
 - [Moving cursor in input box]
 - Select [←] or [→], and push the EDIT button.
 - [Deleting a character]
 - When [DELETE] is selected and the EDIT button is pushed, the character immediately after the cursor is deleted.
 - [Adding a character]
 - When a candidate character is selected from the character list and the EDIT button is pushed, that character is added at the position immediately after the cursor.
 - *A name of up to 12 characters long can be entered as the user name. (A space is also counted as 1 character.)
2. At the end of input, select [ENTER] and push the EDIT button. (To terminate input and return to the original state, select [CANCEL] and push the EDIT button.)

Home screen

Use the EDIT dial to select the following display area to call each setting screen, and push the EDIT button. The setting screen appears.

Airplane/Glider Home Screen

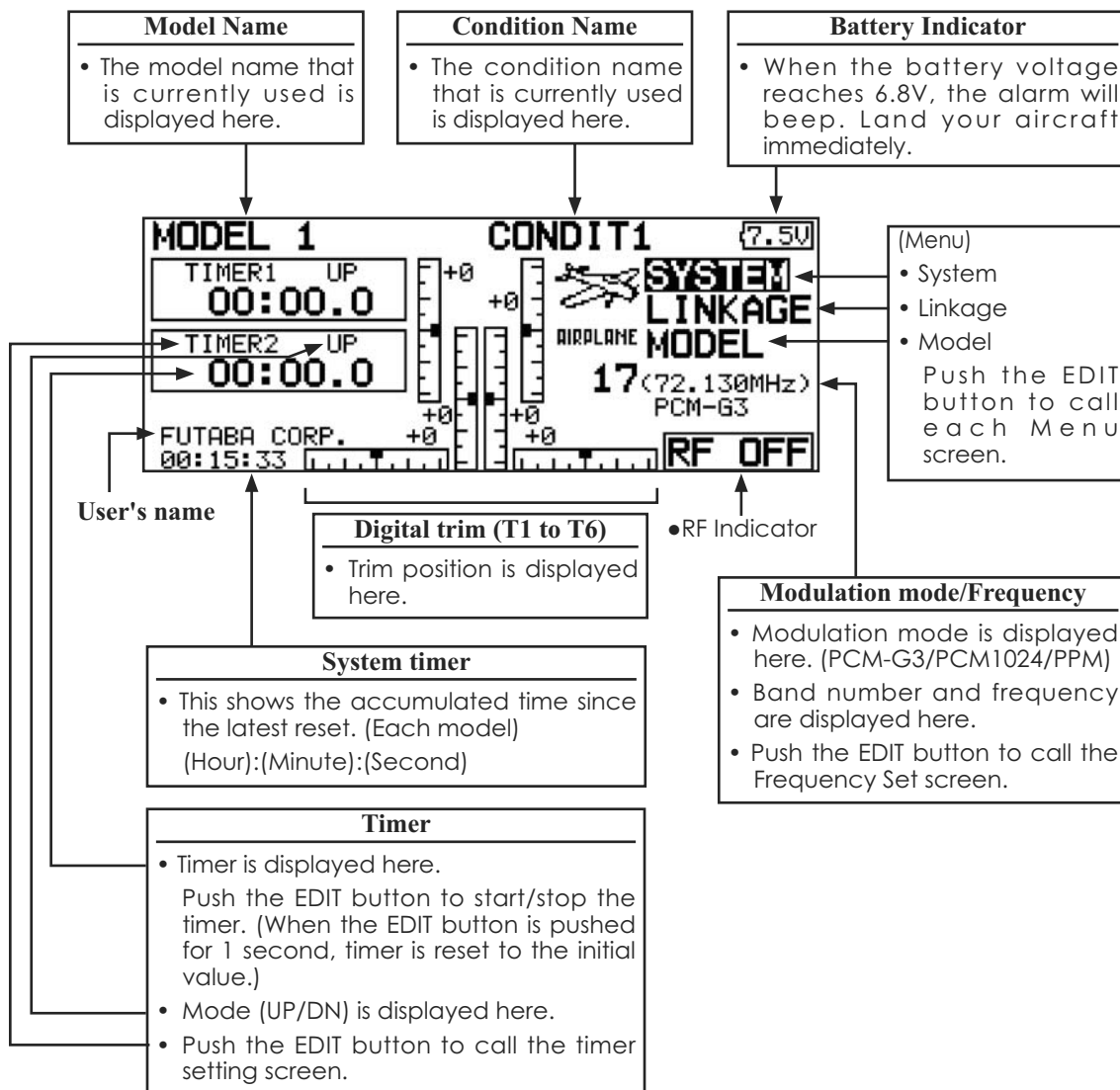

⚠ Warning

- ❗ Be sure to confirm the model name before flying your aircraft.
- ❗ Check the battery voltage as often as possible and try to charge the battery earlier. If the battery alarm makes a sound, land your aircraft immediately.

*You can adjust the LCD contrast by the display setting in the system menu.

Helicopter Home Screen

Throttle/Pitch Position Display

- Throttle and pitch position is displayed here.
Push the EDIT button to call the throttle curve or Pitch curve setting screen directly.

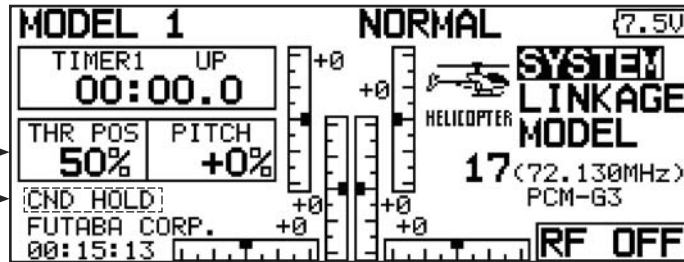

*Condition hold operation is displayed. ("IS ON")

To activate/deactivate Condition Hold:

1. Move the cursor to [CND HOLD].
2. Set the throttle stick lower than the 1/3 point and push the EDIT button to activate/deactivate the condition hold function.

*For a detailed description, refer to [COND. HOLD] function instructions.

SYSTEM MENU

The System Menu sets up functions of the transmitter: This does not set up any model data.

- Select [SYSTEM] at the home screen and call the system menu shown below by pushing the EDIT button.
- Use the EDIT dial to select the function you want to set and call the setup screen by pushing the EDIT button.

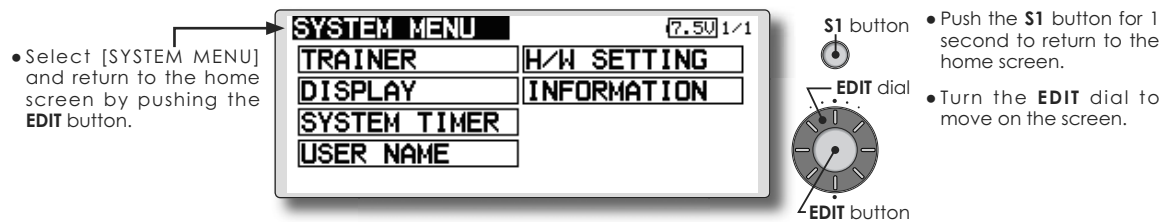

System Menu functions table

[TRAINER]: Starts and sets the trainer system.

[DISPLAY]: LCD contrast adjustment

[SYSTEM TIMER]: Resets the accumulated timer for each model.

[USER NAME]: User name registration

[H/W SETTING]: H/W reverse and stick mode

[INFORMATION]: Displays the program version, SD card information, product ID, and language selection.

The Trainer function makes it possible for the instructor to choose which functions and channels are to be used for instruction, making it possible to match the training ability to the student's skill level. Two transmitters must be connected by an optional Trainer Cord, and the Instructor's transmitter should be programmed for trainer operation, as described below.

When the Instructor activates the trainer switch, the student has control of the aircraft (if MIX or FUNC mode is turned on, the Instructor can make corrections while the student has control). When the switch is released the Instructor regains control. This is very useful if the student gets the aircraft into an undesirable situation.

NOTE: This trainer system can be used in the following manner;

1. **With the T12FG transmitter and a conventional transmitter, if the channel order is different. It is necessary to match the channel order in the Function setting screen when connecting it with other than a T12FG.**
2. **When the T12FG is used as the Teacher, set the modulation mode of the student's transmitter to PPM. If being used as the student, set the T12FG to the modulation mode specified by the Instructor's transmitter. When the Instructor's transmitter is a T14MZ, 12Z, 12FG, T9Z, T9C or T7C transmitter, it should be switched to PPM mode.**
3. **Be sure that all channels work correctly in both transmitters before flying.**

T12FG special trainer cable

Use the T12FG special trainer cable when using the T12FG transmitter at the trainer function instructor side. Operation may not be normal with a conventional trainer cable.

*When the T12FG transmitter is used at the student side when the instructor side transmitter is not a T12FG, a conventional trainer cable may be used.

Instructor	student	Trainer cable
T12FG	T4EX, T6EX, T7C, T9C	T12FG special trainer cable
	T12Z, T14MZ, FX-40	Conventional trainer cable (Rect. - Rect.)
	T4V	Conventional trainer cable (Rect. - Round)
	T6X, T7U, T8U, and T9Z are not applicable.	
Other than T12FG	T12FG	Conventional trainer cable (Rect. - Rect.) or Conventional trainer cable (Rect. - Round)

*The direction that the T12FG special trainer cable connects is fixed. Connect the instructor side connector of the cable to the instructor T12FG and connect the student side connector to the student transmitter. If the cable is connected in reverse, the student side power will not be turned on even if the instructor side power is set to ON.

*If the instructor side T12FG trainer function is not enabled, the student side power will not be turned on even if the connection direction is correct.

- Select [TRAINER] at the system menu and call the setup screen shown below by pushing the EDIT button.

• Select the function name and return to the preceding screen by pushing the **EDIT** button.

The screenshot shows the TRAINER menu with the following settings: ACT/INH (INH), TEACHER/STUDENT (STUD), 12/8 CHANNEL (8CH), and MODULATION (PPM). The top right corner shows (7.50) 1/1. To the right, a diagram shows the S1 button and the EDIT dial. Labels indicate: S1 button, EDIT dial, and EDIT button.

- Push the **S1** button for 1 second to return to the home screen.
- Turn the **EDIT** dial to move on the screen.

When using at the student side

1. Select the mode.

*When changing the mode, use the EDIT dial to move to the item you want to change and push the EDIT button to switch to the data input mode and change the mode by turning the EDIT dial to the left or right. The display blinks. Press the EDIT button to change the mode.

"TEACHER/STUDENT": Select [STUD] (student).

"ACT/INH": Enable operation by changing to [ON].

"12/8 CHANNEL": When the student uses a T12FG (including the T14MZ, T12Z and FX40), select [12CH]. Otherwise select [8CH].

"MODULATION": Set to the mode ([PPM] or [PCM]) specified by the student side transmitter.

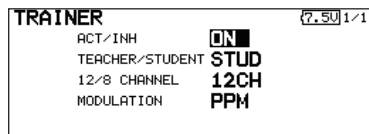

Note: In "student mode", only the teacher side can turn on and off the power to the student's transmitter. Keep the power switch always at off position.

When using at the teacher side

1. Select the mode.

*When changing the mode, use the EDIT dial to move to the item you want to change and push the EDIT button to switch to the data input mode and change the mode by turning the EDIT dial to the left or right. The display blinks. Press the EDIT button to change the mode.

"TEACHER/STUDENT": Select [TEACH].

"ACT/INH": Enable operation by changing to [OFF] or [ON].

"12/8 CHANNEL": When the student uses the T12FG (including the T14MZ, T12Z or FX-40), select [12CH]. Otherwise select [8CH].

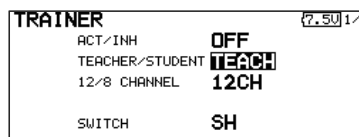

2. Select the trainer switch.

*When setting or changing the switch, use the EDIT dial to move to the "SWITCH" item, call the switch setup screen by pushing the EDIT button and set the desired switch and ON/OFF direction.

(See "Switch selection method" at the end of this manual for selection method details.)

*The switch mode can also be selected when setting the ON position on the switch setup screen. When [NORM] is selected, normal ON/OFF operation is performed. When [ALTERNATE] is selected, the trainer function is alternately turned on and off each time the switch is operated. This allows alternate ON/OFF switching even when a momentary switch (SH) is used.

Note: The trainer function won't be turned on unless the Instructor's transmitter receives signals from the student's transmitter. Be sure to confirm this after connecting your trainer cable.

3. Select the operating mode for each channel.

CH	FUNCTION	MODE	SW	RATE
1	ELEVATOR	OFF	---	
2	RUDDER	OFF	---	
3	THROTTLE	OFF	---	
4	AILERON	OFF	---	

The screenshot shows the TRAINER menu with a table of channel settings. The top right corner shows (7.50) 2/4.

*Use the EDIT dial to move the cursor to the "MODE" item of the channel you want to change and push the EDIT button to switch to the data input mode and change the mode by turning the EDIT dial to the left or right. The display blinks. Press the EDIT button to change the mode.

"NORM": The model is controlled by signals from the student transmitter.

"MIX" mode: The model is controlled by signals from the teacher and student transmitters. (Reset the student's model data to the default condition.)

"FUNC" mode (function mode):

The model is controlled by signals from the student transmitter with the teacher AFR setting. (Reset the student's model data to the default condition.)

"OFF": Only the teacher side operates.

*The setting above allows setting of the servo throw relative to the amount of student side operation when [MIX] or [FUNC] was selected.

When changing the rate, use the EDIT dial to move the cursor to the [RATE] item of the channel you want to change and use the EDIT dial to adjust the rate.

Setting range: -100~+100

Initial value: +100

Push the EDIT button to end adjustment and return to the cursor move mode.

*When the EDIT button is pushed for 1 second, the rate is reset to the initial value.

3. Set the switch of each channel.

*When setting the switch at each channel, use the EDIT dial to move to the "SW" item of the channel you want to change, call the switch setup screen by pushing the EDIT button, and select the switch.

"-" : Always ON.

"SA"~"SH": The switch which enables student side operation can be selected. (See "Switch selection method" at the end of this manual for selection method details.)

LCD contrast adjustment is possible:

- Select [DISPLAY] at the system menu and call the setup screen shown below by pushing the EDIT button.

- Select the function name and return to the preceding screen by pushing the **EDIT** button.

DISPLAY 7.50 1/1

LCD CONTRAST **15**



S1 button

EDIT dial

EDIT button

- Push the **S1** button for 1 second to return to the home screen.
- Turn the **EDIT** dial to move on the screen.

LCD contrast adjustment

1. Use the EDIT dial to select "LCD CONTRAST" and push the EDIT button to switch to the data input mode and adjust the contrast by turning the EDIT dial to the left and right.

Setting range: (Lighter) 0 to 30 (Darker)

Initial value: 15

Push the EDIT button to end adjustment and return to the cursor move mode.

*Adjust to the contrast while watching the screen display.

*When you want to reset the contrast to the initial state, select "LCD CONTRAST" and push the EDIT button for 1 second.

SYSTEM TIMER Resets the accumulated timer.

This function resets the system timer displayed on the home screen.

- T12FG has two type system timers.

TOTAL timer: Displays the total accumulated time on the transmitter from the last time the timer was reset.

MODEL timer: Displays the total accumulated

time on each model from the last time the timer was reset.

- System timer displayed on the home screen can be selected.

- Select [SYSTEM TIMER] at the system menu and call the setup screen shown below by pressing the EDIT button.

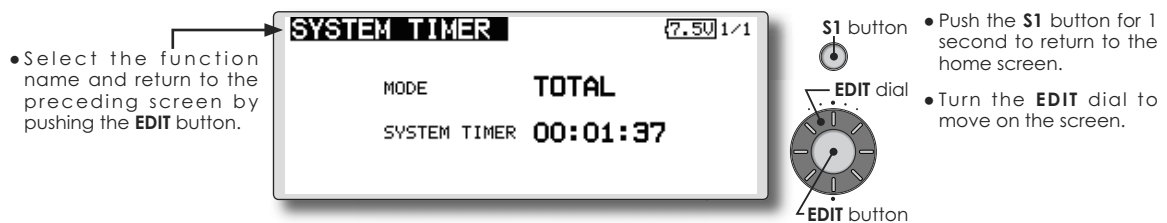

Timer selection

1. Move the cursor to the [MODE] item and push the EDIT button to switch to the data input mode.

Select the mode by turning the EDIT dial and push the EDIT button.

TOTAL: Displays the total timer on the home screen.

MODEL timer: Displays the model timer on the home screen.

Timer reset

1. Move the cursor to the [SYSTEM TIMER] item and reset the timer to "00:00:00" by pushing the EDIT button for 1 second. After reset, the timer restarts from "00:00:00".

USER NAME

User name registration

This function registers the T12FG user name.

*A name of up to 12 characters can be entered as the user name. (Space is also counted as 1 character.)

- Select [USER NAME] at the system menu and call the setup screen shown below by pressing the EDIT button.

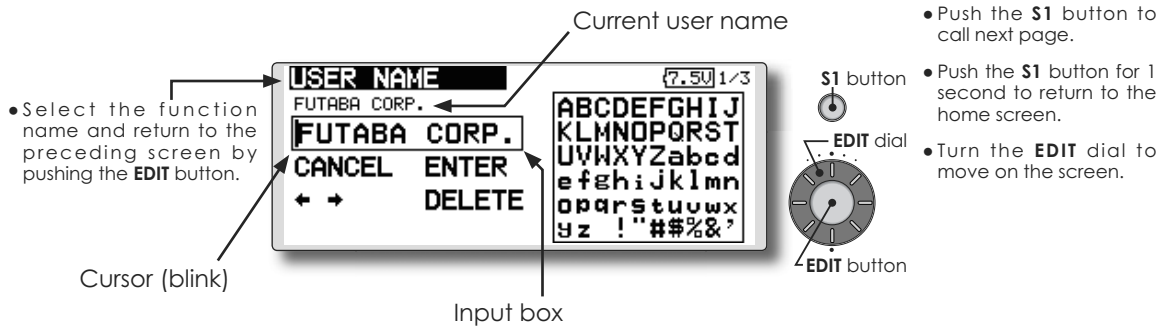

User name registration

1. Change the user name as described below:

[Moving cursor in input box]

Select [←] or [→], and push the EDIT button.

[Deleting a character]

When [DELETE] is selected and the EDIT button is pushed, the character immediately after the cursor is deleted.

[Adding a character]

When a candidate character is selected from the character list and the EDIT button is pushed, that character is added at the position immediately after the cursor.

*A name of up to 12 characters long can be entered as the user name. (A space is also counted as 1 character.)

2. At the end of input, select [ENTER] and push the EDIT button. (To terminate input and return to the original state, select [CANCEL] and push the EDIT button.)

(Character list 1/3)

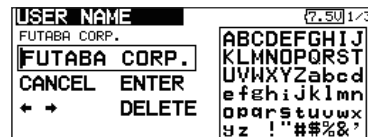

(Character list 2/3)

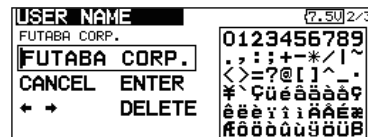

(Character list 3/3)



H/W reverse

This function reverses the operation signal of the sticks, switches, trimmer levers, and knobs.

Note: This setting reverses the actual operation signal, but does not change the display of the indicators on the display. Use the Normal mode as long as there is no special reason to use the Reverse mode.

Stick mode

This function changes the stick mode of transmitter.

Note: This will not change the throttle ratchet, etc. Those are mechanical changes that must be done by a Futaba service center.

Note: After changing the mode, it is applied when setting a new model. It is not applied to an existing model.

- Select [H/W SETTING] at the system menu and call the setup screen shown below by pushing the EDIT button.

Operation direction reversal method

1. Select [H/W REVERSE] and call the setup screen shown below by pushing the EDIT button.

H/W REVERSE						(7.50) 1/2
H/W	MODE	H/W	MODE	H/W	MODE	
J1	NORM	SA	NORM	SE	NORM	
J2	NORM	SB	NORM	SF	NORM	
J3	NORM	SC	NORM	SG	NORM	
J4	NORM	SD	NORM	SH	NORM	

2. Use the EDIT dial to move the cursor to the "MODE" item corresponding to the H/W (hardware) you want to reverse and push the EDIT button to switch to the data input mode.
3. Change the mode by turning the EDIT dial to the left or right. The display blinks. When the EDIT button is pushed, the operation direction is reversed. (To terminate mode change, turn the EDIT dial or push the S1 button.)

"NORM": Normal operation direction

"REV" : Operation direction is reversed.

Operation direction reversal method

1. Select [STICK MODE] and call the setup screen shown below by pushing the EDIT button.

STICK MODE		(7.50) 1/1
STICK MODE	MODE1	

2. Use the EDIT dial to move the cursor to the "STICK MODE" item and push the EDIT button to switch to the data input mode.
3. Change the mode by turning the EDIT dial to the left or right. The display blinks. When the EDIT button is pushed, the stick mode is changed. (To terminate mode change, turn the EDIT dial or push the S1 button.)

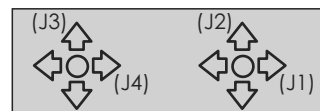

Mode	J1	J2	J3	J4
1	Aileron	Throttle	Elevator	Rudder
2	Aileron	Elevator	Throttle	Rudder
3	Rudder	Throttle	Elevator	Aileron
4	Rudder	Elevator	Throttle	Aileron

INFORMATION

Displays the program version, SD card information, and product ID.

The T12FG system program version information, SD card information (maximum and vacant number of model data), and product ID are displayed on the Information screen.

The language displayed in home, menu, and setup screen is selectable.

*When the SD card is not inserted, the SD card information is not displayed.

- Select [INFORMATION] at the system menu and call the setup screen shown below by pushing the EDIT button.

• Select the function name and return to the preceding screen by pushing the **EDIT** button.



The screenshot shows the 'INFORMATION' screen with the following text: PRODUCT ID : 00300001, LANGUAGE : ENGLISH, VERSION : 1.0, MEMORY CARD SIZE: NO MEMORY CARD, and CARD FREE SIZE : NO MEMORY CARD. The screen also displays '(7.50) 1/1' in the top right corner.



The diagram shows a circular dial labeled 'EDIT dial' and a button labeled 'S1 button'. The dial has a pointer and is used for navigating through the menu items.

- Push the **S1** button for 1 second to return to the home screen.
- Turn the **EDIT** dial to move on the screen.

Information

"PRODUCT ID": Product ID number
"VERSION": T12FG system program version information
"MEMORY CARD SIZE": Maximum number of model data (SD card)
"CARD FREE SIZE": Vacant number of model data (SD card)

Language selection

1. Use the EDIT dial to move the cursor to the "LANGUAGE" item and push the EDIT button to switch to the data input mode.
2. Change the language by turning the EDIT dial to the left or right. The display blinks. When the EDIT button is pushed, the language is changed. (To terminate mode change, turn the EDIT dial or push the S1 button.)

MODEL BASIC SETTING PROCEDURE

Airplane/glider basic setting procedure

1. Model addition and call

Initial setting assigns 1 model to the T12FG transmitter. The Model Select function of the Linkage Menu is used to add models and to select models which are already set.

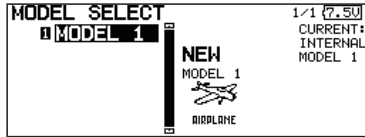

The data for up to 30 models can be saved to the transmitter. Data can also be saved to the optional SD card.

The currently selected model name is displayed at the top of the screen. Before flying and before changing any settings, always confirm the model name.

When a new model is added, the Model type select screen and Frequency/Modulation mode/Receiver ID setup screen automatically appear. Please be aware that the transmitter will stop transmitting when you change the model.

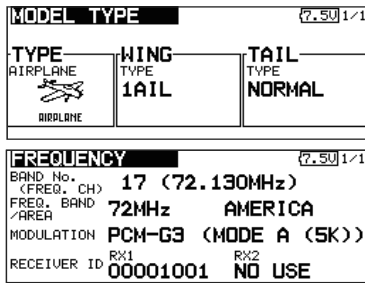

2. Model type selection

Select the model type matched to the aircraft with the Model Type select function of the Linkage Menu. For an airplane, select the model type from among the 2 types: airplane and glider. After the wing type is selected the tail type select screen is displayed. Select the tail type matched to the aircraft.

There are 13 wing types and 3 tail types for airplane and glider.

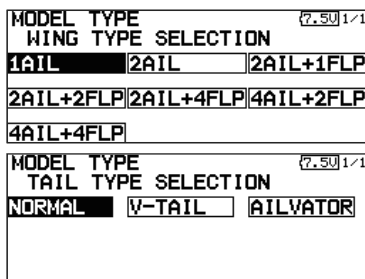

3. Fuselage linkage

Connect the ailerons, elevators, throttle, rudder, etc. in accordance with the model's instruction manual. For a description of the connection method, see the Receiver and Servos Connection.

Note: The channel assignment of the T12FG is different from that of our existing systems. Note that even for the same "airplane model", when the wing type and tail type are different, the channel assignment may be different. (The channel assigned to each function can be checked at the Function menu of the Linkage Menu.)

FUNCTION		CONDIT1 (7.50) 1/5	
CH	FUNCTION	CONTROL	TRIM
1	ELEVATOR	J3	T3
2	RUDDER	J4	T4
3	THROTTLE	J2	T2
4	AILERON	J1	T1

- If the direction of the servo is incorrect, adjust the direction with the Reverse function of the Linkage Menu.

SERVO REVERSE (7.50) 1/2					
CH	FUNCTION	MODE	CH	FUNCTION	MODE
1	ELEVATOR	NORM	5	GEAR	NORM
2	RUDDER	NORM	6	AIR BRAKE	NORM
3	THROTTLE	NORM	7	AUXILIARY6	NORM
4	AILERON	NORM	8	AUXILIARY5	NORM

- Adjust the neutral position and control surface angle with the linkage, and fine tune them with the Sub Trim and End Point functions (angle adjustment). To protect the linkage, a limit position can also be set with the End Point function. The End Point function can adjust the amount of up/down and left/right movement, limit, and servo speed of each channel.

SUB-TRIM (7.50) 1/2			
CH	FUNCTION	+	-
1	ELEVATOR	+0	5 GEAR +0
2	RUDDER	+0	6 AIR BRAKE +0
3	THROTTLE	+0	7 AUXILIARY6 +0
4	AILERON	+0	8 AUXILIARY5 +0

END POINT (7.50) 1/3				
CH	FUNCTION	LIMIT	TRAV. TRAV.	LIMIT SPEED
1	ELEVATOR	135%	100%	100% 135% 0
2	RUDDER	135%	100%	100% 135% 0
3	THROTTLE	135%	100%	100% 135% 0
4	AILERON	135%	100%	100% 135% 0

4. Throttle cut setting

Throttle cut can be performed with one touch by a switch without changing the throttle trim position.

Set throttle cut with the Throttle Cut function of the Linkage Menu. After activating the throttle cut function and selecting the switch, adjust the throttle position so that the carburetor becomes fully closed. For safety, the throttle cut function operates the throttle stick in the 1/3 or less (slow side) position.

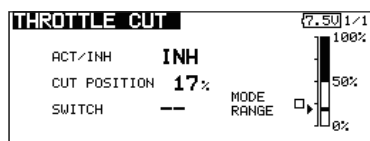

5. Idle down setting

The idling speed can be lowered with one touch by a switch without changing the throttle trim position. Perform this setting with the Idle Down function of the Linkage Menu. After activating the Idle Down function and selecting the switch, adjust the idle down speed. For safety, the idle down function acts only when the throttle stick is slow side.

*While the Throttle Cut function is in operation, the Idle Down function does not work.

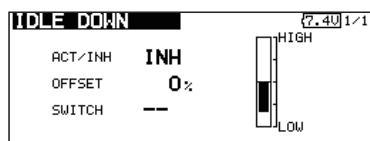

6. AFR (D/R)

AFR function is used to adjust the throw and operation curve of the stick, lever, and switch functions (CH1 to CH12, and V1 to V4) for each flight condition. This is normally used after End Point has defined the maximum throw directions.

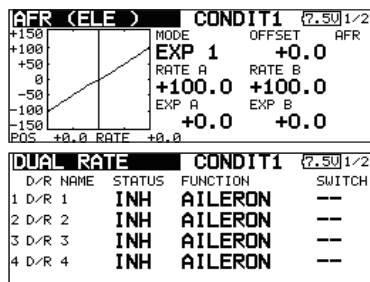

7. Airbrake

This function is used when an air brake is necessary when taking off or diving, etc.

The preset elevators and flaps (camber flap, brake flap) offset amount can be activated by a switch.

The offset amount of the aileron, elevator, and flap servos can be adjusted as needed. Also the speed of the aileron, elevator, and flap servos can be adjusted. (IN side/OUT side) A delay can be set for each condition, and a Cut switch which will turn OFF the delay can be chosen. Trim amounts can be fine-tuned by setting a VR. You can also set the Auto Mode, which will link Airbrake to a stick, switch, or dial. A separate stick switch or dial can also be set as the ON/OFF switch.

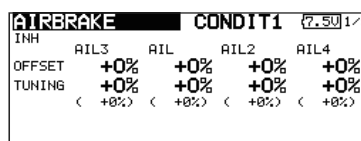

8. Addition of flight conditions

The Condition Select function automatically allocates the Condition 1 (CONDIT1) for each model. Condition 1 is the default condition and is the only one active when a new model type is defined.

If you want to add flight conditions, please refer to a description of the COND. SELECT function, p.72.

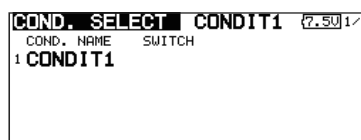

*The Condition 1 is always on, and remains on until other conditions are activated by switches.

*When a new condition is added, the model data of the Condition 1 is automatically copied to the new condition.

*You can set the model data of new condition in the switch ON state. However, if the group mode (GROUP) was selected in advance, the same data will be input at all the conditions. Select the single mode (SINGLE) and adjust only the condition you want to change. For Group/Single mode switching, refer to the description at the back of this manual.

*The Condition Delay can be programmed for each channel. The Condition Delay is used to change the servo throw smoothly when switching conditions.

9. When tailless wing model selected

Tailless wing elevator operation uses elevator to camber mixing. This function cannot be performed at initial setting.

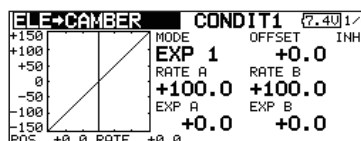

Helicopter basic setting procedure

This section outlines examples of use of the helicopter functions of the T12FG. Adjust the actual values, etc. to match the fuselage used.

1. Model addition and call

Default setting assigns 1 model to the T12FG. To add new models or to call a model already set, use the Model Select function of the Linkage Menu.

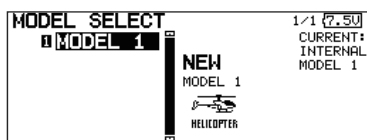

This is convenient when calling a model after registering the model names in advance. (The data of up to 30 models can be saved at the transmitter. Data can also be saved to the optional SD card.)

The currently called model is displayed at the top of the screen. Before flying and before changing any settings, always confirm the model name.

When a new model is added, the Model Type Select screen and Frequency/Modulation mode/Receiver ID setup screen automatically appear. Change, or check that they match the type, frequency, and receiver type of the model used.

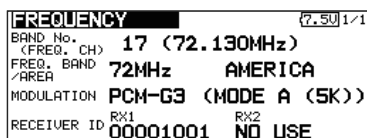
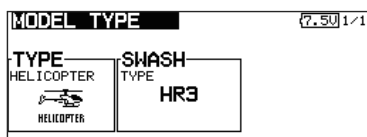

2. Model type and swash type selection

If a different model type is already selected, select helicopter with the Model Type function of the Linkage Menu, and then select the swash type matched to the helicopter.

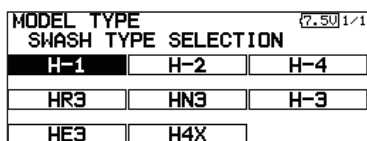
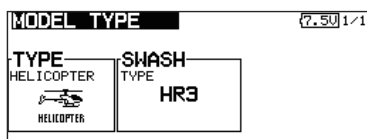

*The Model Type function automatically selects the appropriate output channels, control functions, and mixing

functions for the chosen model type. Eight swash types are available for helicopters.

*For a description of the swash type selection, refer to the MODEL TYPE function, p.51.

3. Flight condition addition

The transmitter can install up to eight flight conditions per model.

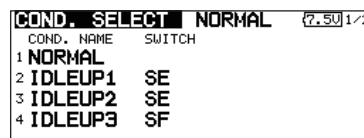

The Condition Select function automatically allocates five conditions for helicopter.

(Initial setting)

- NORMAL
- IDLE UP1 (SW-E)
- IDLE UP2 (SW-E)
- IDLE UP3 (SW-F)
- HOLD (SW-G)

Note: Since you may accidentally activate the conditions that has not been setup during flight and this could cause a crash, delete the conditions not used.

*For a description of the condition deletion, refer to the COND. SELECT function, p.72.

The NORMAL condition is always on, and remains on until other conditions are activated by switches.

The priority is throttle hold/idle up 2/idle up 1/normal. Throttle hold has the highest priority.

Add other conditions, as required.

The Condition Delay can be programmed for each channel. The Condition Delay is used to change the servo throw smoothly when switching conditions.

(General flight condition setting example)

- Normal: (Use initial setting conditions/operate when switch OFF)
Use from engine starting to hovering.
- Idle up 1: (Operate at SW-E center)
Use in 540° stall turn, loop, rolling stall turn, and other maneuvers.
- Idle up 2: (Operate at SW-E forward side)
Use in rolls.
- Throttle hold: (Operate at SW-G forward side)
Use in auto rotation.

4. Fuselage linkage

Connect the throttle rudder, aileron, elevator, pitch, and other servos in accordance with the kit instruction manual. For a description of the connection method, see "Receiver and Servos Connection".

Note: The channel assignment of the T12FG is different from that of our existing systems. (The channel assigned to each function can be checked at the Function menu of the Linkage Menu.)

FUNCTION				NORMAL	(7.5U) 1/5
CH	FUNCTION	CONTROL	TRIM		
1	THROTTLE	J2	T2	SEPAR	
2	RUDDER	J4	T4	SEPAR	
3	GYRO	--	--		
4	AILERON	J1	T1	SEPAR	

- If the direction of operation of the servo is incorrect, use the Reverse function of the Linkage Menu. Also use the swash AFR function in other than the H-1 mode.

SERVO REVERSE				(7.5U) 1/2	
CH	FUNCTION	MODE	CH	FUNCTION	MODE
1	THROTTLE	NORM	5	ELEVATOR	NORM
2	RUDDER	NORM	6	PITCH	NORM
3	GYRO	NORM	7	GOVERNOR	NORM
4	AILERON	NORM	8	GOVERNOR2	NORM

SWASH				(7.5U) 1/3
NEUTRAL POINT		SWASH AFR		
POINT	50%	AILERON	+50%	
HIGH PITCH	□	ELEVATOR	+50%	
LOW PITCH	■	PITCH	+50%	

- Adjust the direction of operation of the gyro. (Gyro side function)
- Connect the throttle linkage so that the carburetor can fully close at full trim throttle cut.
- Adjust the neutral position at the linkage side and fine tune with the Sub-Trim function and End Point function (rudder angle adjustment). To protect the linkage, a limit position can also be set with the End Point function.

SUB-TRIM				(7.5U) 1/2	
CH	FUNCTION		CH	FUNCTION	
1	THROTTLE	+0	5	ELEVATOR	+0
2	RUDDER	+0	6	PITCH	+0
3	GYRO	+0	7	GOVERNOR	+0
4	AILERON	+0	8	GOVERNOR2	+0

END POINT					(7.5U) 1/3
CH	FUNCTION	LIMIT TRAV.	TRAV.	LIMIT SPEED	
1	THROTTLE	135%	100%	100%	135% 0
2	RUDDER	135%	100%	100%	135% 0
3	GYRO	135%	100%	100%	135% 0
4	AILERON	135%	100%	100%	135% 0

- Swash plate correction (Except H-1 mode)
*If any interactions are noticed, for a description of the linkage correction function, please refer to the SWASH function, p.65.

5. Throttle/Pitch curve setting

This function adjusts the throttle or pitch operation curve in relation to the movement of the throttle stick for each condition.

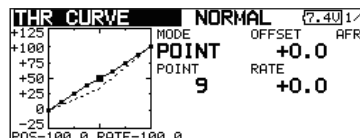

<Throttle curve setting example>

Call the throttle curve of each condition with the condition select switch.

- Normal curve adjustment
Normal curve creates a basic throttle curve centered near hovering. This curve is adjusted together with the pitch curve (Normal) so that the engine speed is constant and up/down control is easiest.
- Idle up curve adjustment
The low side Throttle curve creates a curve matched for aerobatics (loop, roll, 3D, etc.).
- Throttle hold curve adjustment
The curve is not used when performing auto rotation dives.
Confirm that the rate of the slowest position (0%) of the stick is 0% (initial setting).

<Example of pitch curve setting>

Call the pitch curve of each condition with the condition select switch.

- Pitch curve (Normal)
Make the pitch at hovering approximately +5°~6°. Set the pitch at hovering with the stick position at the 50% point as the standard.
*Stability at hovering may be connected to the throttle curve. Adjustment is easy by using the hovering throttle function and hovering pitch function together.
- Pitch curve (Idle up 1)
The idle up 1 pitch curve function creates a curve matched to airborne flight. Set to -7°~+12° as standard.
- Pitch curve (Idle up 2)
The high side pitch setting is less than idle up 1. The standard is +8°.
- Pitch curve (Hold)
At auto rotation, use the maximum pitch at both the high and low sides.
[Pitch angle setting example]
Throttle hold: -7°~+12°

6. AFR (D/R)

AFR (D/R) function is used to adjust the throw and operation curve of aileron, elevator and rudder for each condition.

*For throttle and pitch curve settings, refer to the above-mentioned "Throttle/Pitch curve setting"

This is normally used after End Point has defined the maximum throw directions.

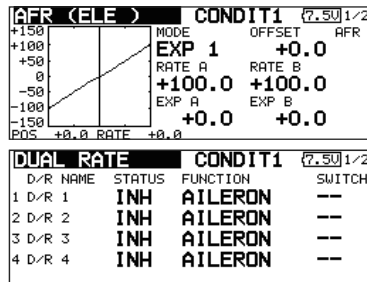

7. Gyro sensitivity and mode switching

The gyro sensitivity and mode switching function is dedicated gyro mixing of the Model Menu, and can be set for each condition.

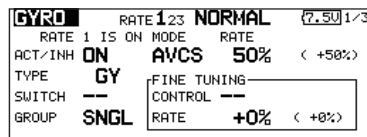

- Normal condition (hovering): Gyro sensitivity maximum
- Idle up 1/Idle up 2/Throttle hold: Gyro sensitivity minimum
- However, at auto rotation of a tail-driven helicopter, this function may not have any effect at high gyro sensitivity.

8. Pitch to RUD mixing setting

Note: When using a GY601, GY502, GY401, or other heading hold gyro, this Pitch to RUD mixing should not be used. The reaction torque is corrected at the gyro side. When operating the gyro in the AVCS mode, the mixed signal will cause neutral deviation symptoms and the gyro will not operate normally.

Use this function when you want to suppress the torque generated by the changes in the pitch and speed of the main rotor during pitch operation. Adjust it so that the nose does not swing in the rudder direction. However, when using a heading hold gyro like those shown below, do not use Pitch to RUD mixing.

Call the Pitch to RUD mixing function from the

Model Menu, and set the curve for each condition. (At initial setting, this function is in the "INH" state. To use it, set it to the "ON" state.)

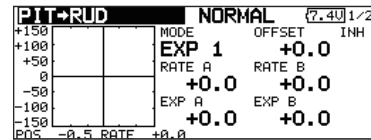

<Setting example>

Call the mixing curve of each condition with the condition select switch.

1. A curve setting example is shown below.

- Pitch to RUD mixing curve (Normal)
 - Use the hovering system and set this curve to match take off and landing and vertical climb at a constant speed.
 - *For this curve, use the initial setting [EXP1] curve type.
- Pitch to RUD mixing (Idle up 1)
 - Use this curve in 540° stall turn, loop, and rolling stall turn, and adjust it so the fuselage is facing straight ahead when heading into the wind.
 - *For this curve, [EXP1] curve type can be used and the entire curve can be lowered with the [Offset] function.
- Pitch to RUD mixing (Hold)
 - This function is set so that the fuselage is facing straight ahead at straight line auto rotation. The pitch of the tail rotor becomes nearly 0°.
 - *For this curve, [EXP1] curve type can be used and the entire curve can be lowered with the [Offset] function.
- Other settings
 - The mixing rise characteristic at pitch operation can be adjusted. An acceleration function which temporarily increases and decreases the mixing amount can be set.

9. Throttle hold setting

*If throttle hold is necessary, please refer to the THR HOLD function, p.113.

10. Throttle cut setting

Throttle cut provides an easy way to stop the engine, by flipping a switch with the throttle stick at idle. The action is not functional at high throttle to avoid accidental dead sticks. The switch's location and direction must be chosen, as it defaults to NULL.

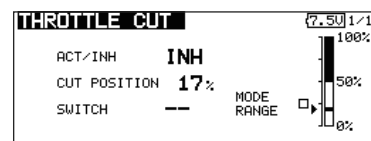

*With throttle stick at idle, adjust the cut position until the engine consistently shuts off, but throttle linkage is not binding.

11. Swash Mix corrects aileron, elevator and pitch interaction

The swash mix function is used to correct the swash plate in the aileron (Left/Right Cyclic) and elevator (Forward/Aft Cyclic) direction corresponding to each operation of each condition.

MIXING	ACT	SWITCH	TRIM	GROUP
AIL+ELE	INH	--	OFF	SINGLE
ELE+AIL	INH	--	OFF	SINGLE
PIT+AIL	INH	--		SINGLE
PIT+ELE	INH	--		SINGLE

12. Throttle mixing setting

*If throttle mixing is necessary for a compensation for slowing of engine speed caused by swash plate operation during aileron or elevator operation, please refer to the THROTTLE MIX function, p.113.

13. Other special mixings

●Pitch to Needle mixing

This mixing is used with engines with a construction which allows needle control during flight (fuel-air mixture adjustment). A needle curve can be set. The needle servo rise characteristics at throttle stick acceleration/deceleration operation can be adjusted. (Acceleration function)

●Governor mixing

This mixing is dedicated governor mixing when a GV-1 (governor) is used. Up to 3 rates (speeds) can be switched for each condition.

Receiver and servo connection

Connect the receiver and servos in accordance with the connection diagram shown below. Always read [Precautions when mounting the receiver and servos] or [Before using]. When mounting the receiver and servos to the fuselage, connect the necessary points in accordance with the kit instruction manual.

Receiver and servos connection diagram

- Always connect the necessary number of servos.
- The receiver channel assignment depends on the model type. See the Servo connection by model type tables.

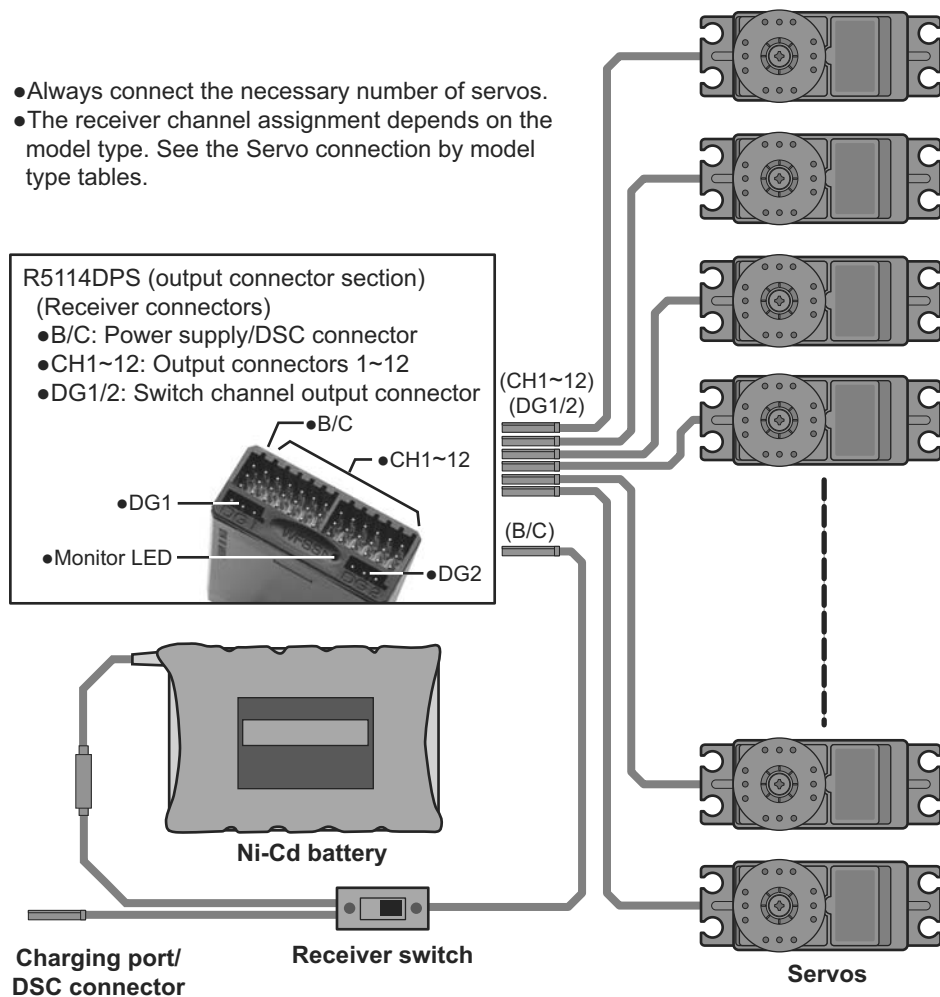

The Servo connection by model type tables are shown on the following pages. Connect the servos to match the fuselage used.

Servo connection by model type

The T12FG transmitter channels are automatically assigned for optimal combination according to the type selected with the Model Type function of the Linkage Menu. The channel assignment (initial setting) for each model type is shown below. Connect the receiver and servos to match the type used.

*The set channels can be checked at the Function screen of the Linkage Menu. The channel assignments can also be changed. For more information, read the description of the Function menu.

Airplane/glider/motor glider

•Airplane and V tail

[PCM-G3 mode]

RX CH	1AIL		2AIL		2AIL+1FLAP		2AIL+2FLAP		2AIL+4FLAP		4AIL+2FLAP		4AIL+4FLAP	
	Airplane	Glider	Airplane	Glider	Airplane	Glider	Airplane	Glider	Airplane	Glider	Airplane	Glider	Airplane	Glider
1	Elevator	Elevator	Elevator	Elevator	Elevator	Elevator	Elevator	Elevator	Elevator	Elevator	Elevator	Elevator	Elevator	Elevator
2	Rudder	Rudder	Rudder	Rudder	Rudder	Rudder	Rudder	Rudder	Rudder	Rudder	Rudder	Rudder	Rudder	Rudder
3	Throttle	Motor	Throttle	Motor	Throttle	Motor	Throttle	Motor	Throttle	Motor	Throttle	Motor	Throttle	Motor
4	Aileron	Aileron	Aileron	Aileron	Aileron	Aileron	Aileron	Aileron	Aileron	Aileron	Aileron	Aileron	Aileron	Aileron
5	Gear	AUX7	Aileron2	Aileron2	Aileron2	Aileron2	Aileron2	Aileron2	Aileron2	Aileron2	Aileron2	Aileron2	Aileron2	Aileron2
6	Airbrake	Airbrake	Gear	AUX7	Flap	Flap	Gear	AUX5	Gear	AUX3	Gear	AUX3	Gear	AUX1
7	AUX6	AUX6	AUX6	AUX6	Gear	AUX6	Flap	Flap	Flap	Flap	Aileron3	Aileron3	Aileron3	Aileron3
8	AUX5	AUX5	AUX5	AUX5	AUX5	AUX5	Flap2	Flap2	Flap2	Flap2	Aileron4	Aileron4	Aileron4	Aileron4
9	AUX4	AUX4	AUX4	AUX4	AUX4	AUX4	AUX4	AUX4	Flap3	Flap3	Flap1	Flap1	Flap1	Flap1
10	AUX3	AUX3	AUX3	AUX3	AUX3	AUX3	AUX3	AUX3	Flap4	Flap4	Flap2	Flap2	Flap2	Flap2
11	AUX2	AUX2	AUX2	AUX2	AUX2	AUX2	AUX2	AUX2	AUX2	AUX2	AUX2	AUX2	Flap3	Flap3
12	AUX1	AUX1	AUX1	AUX1	AUX1	AUX1	AUX1	AUX1	AUX1	AUX1	AUX1	AUX1	Flap4	Flap4
VC1	AUX1	AUX1	Camber	Camber	Camber	Camber	Camber	Camber	Camber	Camber	Camber	Camber	Camber	Camber
VC2	AUX1	AUX1	AUX1	Butterfly	AUX1	Butterfly	AUX1	Butterfly	AUX1	Butterfly	AUX1	Butterfly	AUX1	Butterfly
VC3	AUX1	AUX1	AUX1	AUX1	AUX1	AUX1	AUX1	AUX1	AUX1	AUX1	AUX1	AUX1	AUX1	AUX1
VC4	AUX1	AUX1	AUX1	AUX1	AUX1	AUX1	AUX1	AUX1	AUX1	AUX1	AUX1	AUX1	AUX1	AUX1

•VC1~4 are virtual channels without receiver output. For more information, see the description of the Function menu of the Linkage Menu.

[PCM1024/PPM mode]

RX CH	1AIL		2AIL		2AIL+1FLAP		2AIL+2FLAP		2AIL+4FLAP		4AIL+2FLAP	
	Airplane	Glider	Airplane	Glider	Airplane	Glider	Airplane	Glider	Airplane	Glider	Airplane	Glider
1	Elevator	Elevator	Elevator	Elevator	Elevator	Elevator	Elevator	Elevator	/	Aileron	/	Aileron
2	Rudder	Rudder	Rudder	Rudder	Rudder	Rudder	Rudder	Rudder	/	Aileron2	/	Aileron2
3	Throttle	Motor	Throttle	Motor	Throttle	Motor	Throttle	Motor	/	Flap	/	Aileron3
4	Aileron	Aileron	Aileron	Aileron	Aileron	Aileron	Aileron	Aileron	/	Flap2	/	Aileron4
5	Gear	AUX7	Aileron2	Aileron2	Aileron2	Aileron2	Aileron2	Aileron2	/	Flap3	/	Flap
6	Airbrake	Airbrake	Gear	AUX7	Flap	Flap	Gear	AUX5	/	Flap4	/	Flap2
7	AUX6	AUX6	AUX6	AUX6	Gear	AUX6	Flap	Flap	/	Rudder	/	Rudder
8	AUX5	AUX5	AUX5	AUX5	AUX5	AUX5	Flap2	Flap2	/	Elevator	/	Elevator
VC1	AUX1	AUX1	Camber	Camber	Camber	Camber	Camber	Camber	/	Camber	/	Camber
VC2	AUX1	AUX1	AUX1	Butterfly	AUX1	Butterfly	AUX1	Butterfly	/	Butterfly	/	Butterfly
VC3	AUX1	AUX1	AUX1	AUX1	AUX1	AUX1	AUX1	AUX1	/	AUX1	/	AUX1
VC4	AUX1	AUX1	AUX1	AUX1	AUX1	AUX1	AUX1	AUX1	/	AUX1	/	AUX1

•VC1~4 are virtual channels without receiver output. For more information, see the description of the Function menu of the Linkage Menu.

●Ailvator

[PCM-G3 mode]

RX CH	1AIL		2AIL		2AIL+1FLAP		2AIL+2FLAP		2AIL+4FLAP		4AIL+2FLAP		4AIL+4FLAP	
	Airplane	Glider	Airplane	Glider	Airplane	Glider	Airplane	Glider	Airplane	Glider	Airplane	Glider	Airplane	Glider
1	Elevator	Elevator	Elevator	Elevator	Elevator	Elevator	Elevator	Elevator	Elevator	Elevator	Elevator	Elevator	Elevator	Elevator
2	Elevator2	Elevator2	Elevator2	Elevator2	Elevator2	Elevator2	Elevator2	Elevator2	Elevator2	Elevator2	Elevator2	Elevator2	Elevator2	Elevator2
3	Rudder	Rudder	Rudder	Rudder	Rudder	Rudder	Rudder	Rudder	Rudder	Rudder	Rudder	Rudder	Rudder	Rudder
4	Aileron	Aileron	Aileron	Aileron	Aileron	Aileron	Aileron	Aileron	Aileron	Aileron	Aileron	Aileron	Aileron	Aileron
5	Throttle	Motor	Aileron2	Aileron2	Aileron2	Aileron2	Aileron2	Aileron2	Aileron2	Aileron2	Aileron2	Aileron2	Aileron2	Aileron2
6	Airbrake	Airbrake	Throttle	Motor	Throttle	Motor	Throttle	Motor	Throttle	Motor	Throttle	Motor	Throttle	Motor
7	Gear	AUX6	Gear	AUX6	Flap	Flap	Flap	Flap	Flap	Flap	Aileron3	Aileron3	Aileron3	Aileron3
8	AUX5	AUX5	AUX5	AUX5	Gear	AUX5	Flap2	Flap2	Flap2	Flap2	Aileron4	Aileron4	Aileron4	Aileron4
9	AUX4	AUX4	AUX4	AUX4	AUX4	AUX4	Gear	AUX4	Flap3	Flap3	Flap1	Flap1	Flap1	Flap1
10	AUX3	AUX3	AUX3	AUX3	AUX3	AUX3	AUX3	AUX3	Flap4	Flap4	Flap2	Flap2	Flap2	Flap2
11	AUX2	AUX2	AUX2	AUX2	AUX2	AUX2	AUX2	AUX2	Gear	AUX2	Gear	AUX2	Flap3	Flap3
12	AUX1	AUX1	AUX1	AUX1	AUX1	AUX1	AUX1	AUX1	AUX1	AUX1	AUX1	AUX1	Flap4	Flap4
VC1	AUX1	AUX1	Camber	Camber	Camber	Camber	Camber	Camber	Camber	Camber	Camber	Camber	Camber	Camber
VC2	AUX1	AUX1	AUX1	Butterfly	AUX1	Butterfly	AUX1	Butterfly	AUX1	Butterfly	AUX1	Butterfly	AUX1	Butterfly
VC3	AUX1	AUX1	AUX1	AUX1	AUX1	AUX1	AUX1	AUX1	AUX1	AUX1	AUX1	AUX1	AUX1	AUX1
VC4	AUX1	AUX1	AUX1	AUX1	AUX1	AUX1	AUX1	AUX1	AUX1	AUX1	AUX1	AUX1	AUX1	AUX1

●VC1~4 are virtual channels without a receiver output. For more information, see the description of the Function menu of the Linkage Menu.

[PCM1024/PPM mode]

RX CH	1AIL		2AIL		2AIL+1FLAP		2AIL+2FLAP	
	Airplane	Glider	Airplane	Glider	Airplane	Glider	Airplane	Glider
1	Elevator	Elevator	Elevator	Elevator	Elevator	Elevator	Elevator	Elevator
2	Elevator2	Elevator2	Elevator2	Elevator2	Elevator2	Elevator2	Elevator2	Elevator2
3	Rudder	Rudder	Rudder	Rudder	Rudder	Rudder	Rudder	Rudder
4	Aileron	Aileron	Aileron	Aileron	Aileron	Aileron	Aileron	Aileron
5	Throttle	Motor	Aileron2	Aileron2	Aileron2	Aileron2	Aileron2	Aileron2
6	Airbrake	Airbrake	Throttle	Motor	Throttle	Motor	Throttle	Motor
7	Gear	AUX6	Gear	AUX6	Flap	Flap	Flap	Flap
8	AUX5	AUX5	AUX5	AUX5	Gear	AUX5	Flap2	Flap2
VC1	AUX1	AUX1	Camber	Camber	Camber	Camber	Camber	Camber
VC2	AUX1	AUX1	AUX1	Butterfly	AUX1	Butterfly	AUX1	Butterfly
VC3	AUX1	AUX1	AUX1	AUX1	AUX1	AUX1	AUX1	AUX1
VC4	AUX1	AUX1	AUX1	AUX1	AUX1	AUX1	AUX1	AUX1

●VC1~4 are virtual channels without a receiver output. For more information, see the description of the Function menu of the Linkage Menu.

•Tailless wing

[PCM-G3 mode]

RX CH	2AIL		2AIL+1FLAP		2AIL+2FLAP		2AIL+4FLAP		4AIL+2FLAP		4AIL+4FLAP	
	Airplane	Glider	Airplane	Glider	Airplane	Glider	Airplane	Glider	Airplane	Glider	Airplane	Glider
1	Rudder	Rudder	Rudder	Rudder	Rudder	Rudder	Rudder	Rudder	Rudder	Rudder	Rudder	Rudder
2	Rudder2	Rudder2	Rudder2	Rudder2	Rudder2	Rudder2	Rudder2	Rudder2	Rudder2	Rudder2	Rudder2	Rudder2
3	Throttle	Motor	Throttle	Motor	Throttle	Motor	Throttle	Motor	Throttle	Motor	Throttle	Motor
4	Aileron	Aileron	Aileron	Aileron	Aileron	Aileron	Aileron	Aileron	Aileron	Aileron	Aileron	Aileron
5	Aileron2	Aileron2	Aileron2	Aileron2	Aileron2	Aileron2	Aileron2	Aileron2	Aileron2	Aileron2	Aileron2	Aileron2
6	Gear	AUX7	Flap	Flap	Gear	AUX5	Gear	AUX3	Gear	AUX3	Gear	AUX1
7	AUX6	AUX6	Gear	AUX6	Flap	Flap	Flap	Flap	Aileron3	Aileron3	Aileron3	Aileron3
8	AUX5	AUX5	AUX5	AUX5	Flap2	Flap2	Flap2	Flap2	Aileron4	Aileron4	Aileron4	Aileron4
9	AUX4	AUX4	AUX4	AUX4	AUX4	AUX4	Flap3	Flap3	Flap1	Flap1	Flap1	Flap1
10	AUX3	AUX3	AUX3	AUX3	AUX3	AUX3	Flap4	Flap4	Flap2	Flap2	Flap2	Flap2
11	AUX2	AUX2	AUX2	AUX2	AUX2	AUX2	AUX2	AUX2	AUX2	AUX2	Flap3	Flap3
12	AUX1	AUX1	AUX1	AUX1	AUX1	AUX1	AUX1	AUX1	AUX1	AUX1	Flap4	Flap4
VC1	Elevator	Elevator	Elevator	Elevator	Elevator	Elevator	Elevator	Elevator	Elevator	Elevator	Elevator	Elevator
VC2	AUX1	AUX1	Camber	Camber	Camber	Camber	Camber	Camber	Camber	Camber	Camber	Camber
VC3	AUX1	AUX1	AUX1	Butterfly	AUX1	Butterfly	AUX1	Butterfly	AUX1	Butterfly	AUX1	Butterfly
VC4	AUX1	AUX1	AUX1	AUX1	AUX1	AUX1	AUX1	AUX1	AUX1	AUX1	AUX1	AUX1

•VC1~4 are virtual channels without a receiver output. For more information, see the description of the Function menu of the Linkage Menu.

[PCM1024/PPM mode]

RX CH	2AIL		2AIL+1FLAP		2AIL+2FLAP		2AIL+4FLAP			4AIL+2FLAP		
	Airplane	Glider	Airplane	Glider	Airplane	Glider	Airplane	Glider Normal	Glider Winglet	Airplane	Glider Normal	Glider Winglet
1	Rudder	Rudder	Rudder	Rudder	Rudder	Rudder	/	Aileron	Aileron	/	Aileron	Aileron
2	Rudder2	Rudder2	Rudder2	Rudder2	Rudder2	Rudder2	/	Aileron2	Aileron2	/	Aileron2	Aileron2
3	Throttle	Motor	Throttle	Motor	Throttle	Motor	/	Flap	Flap	/	Aileron3	Aileron3
4	Aileron	Aileron	Aileron	Aileron	Aileron	Aileron	/	Flap2	Flap2	/	Aileron4	Aileron4
5	Aileron2	Aileron2	Aileron2	Aileron2	Aileron2	Aileron2	/	Flap3	Flap3	/	Flap	Flap
6	Gear	AUX7	Flap	Flap	Gear	AUX5	/	Flap4	Flap4	/	Flap2	Flap2
7	AUX6	AUX6	Gear	AUX6	Flap	Flap	/	Rudder	Rudder	/	Rudder	Rudder
8	AUX5	AUX5	AUX5	AUX5	Flap2	Flap2	/	AUX1	Rudder2	/	AUX1	Rudder2
VC1	Elevator	Elevator	Elevator	Elevator	Elevator	Elevator	/	Elevator	Elevator	/	Elevator	Elevator
VC2	AUX1	AUX1	Camber	Camber	Camber	Camber	/	Camber	Camber	/	Camber	Camber
VC3	AUX1	AUX1	AUX1	Butterfly	AUX1	Butterfly	/	Butterfly	Butterfly	/	Butterfly	Butterfly
VC4	AUX1	AUX1	AUX1	AUX1	AUX1	AUX1	/	AUX1	AUX1	/	AUX1	AUX1

•VC1~4 are virtual channels without a receiver output. For more information, see the description of the Function menu of the Linkage Menu.

Helicopter

[PCM-G3 mode]

RX CH	H-4, H4X Swash	All Other
1	Throttle	Throttle
2	Rudder	Rudder
3	Aileron	Gyro
4	Elevator	Aileron
5	Pitch	Elevator
6	Elevator 2	Pitch
7	Gyro	Governor 1
8	Governor 1	Governor 2
9	Governor 2	Needle
10	Needle	AUX3
11	AUX2	AUX2
12	AUX1	AUX1
VC1	AUX1	AUX1
VC2	AUX1	AUX1
VC3	AUX1	AUX1
VC4	AUX1	AUX1

- VC1~4 are virtual channels with no receiver output. For more information, see the description of the Function menu of the Linkage Menu.

[PCM1024/PPM mode]

RX CH	H-4, H4X Swash	All Other
1	Throttle	Throttle
2	Rudder	Rudder
3	Aileron	Gyro
4	Elevator	Aileron
5	Pitch	Elevator
6	Elevator 2	Pitch
7	Gyro	Governor 1
8	Governor 1	Governor 2
VC1	AUX1	AUX1
VC2	AUX1	AUX1
VC3	AUX1	AUX1
VC4	AUX1	AUX1

FUNCTIONS OF LINKAGE MENU

The Linkage Menu is made up of functions which perform model addition, model type selection, frequency setting, end point setting, and other model basic settings.

The functions which can be selected depend on the model type. A typical menu screen is shown below.

- Select [LINKAGE] at the home screen and call the linkage menu shown below by pushing the EDIT button.
- Use the EDIT dial to select the function you want to set and call the setup screen by pushing the EDIT button.

- Select the [LINKAGE MENU] and return to the home screen by pushing the EDIT button.

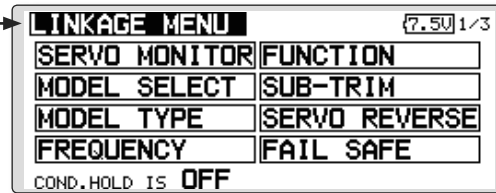

- Push the **S1** button to call next page.
- Push the **S1** button for 1 second to return to the home screen.
- Turn the **EDIT** dial to move on the screen.

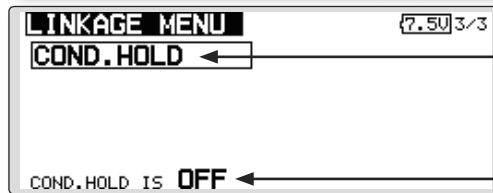
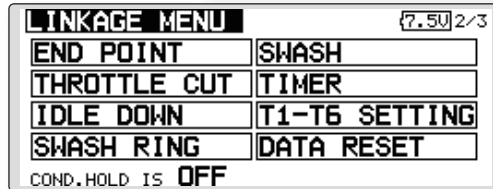

*The display screen is an example. The screen depends on the model type.

To activate/deactivate Condition Hold:

(Helicopter type only)

1. Move the cursor to [COND. HOLD].
2. Set the throttle stick lower than the 1/3 point and push the EDIT button to activate/deactivate the condition hold function.

*Refer to condition hold function details.

*Condition hold operation is displayed.

Linkage Menu functions table

- [SERVO MONITOR]: Displays the servo test and operation position
- [MODEL SELECT]: Model addition, call, deletion, copy, model name setting
- [MODEL TYPE]: Model type, wing type, swash type, etc. selection
- [FREQUENCY]: Frequency selection, modulation mode selection, receiver ID setting
- [FUNCTION]: Channel assignment of each function can be changed
- [SUB-TRIM]: Adjusts the neutral position of each servo
- [SERVO-REVERSE]: Servo direction reversal
- [FAIL SAFE]: Fail safe function and battery fail safe function setting (PCM-G3/PCM1024 only)
- [END POINT]: Servo basic rudder adjustment and limit setting
- [THROTTLE CUT]: Stops the engine safely and easily (airplane and helicopter only)
- [IDLE DOWN]: Lowers the idle speed of the engine (airplane and helicopter only)
- [SWASH RING]: Limits the swash plate travel to within a fixed range. (helicopter only)
- [SWASH]: Swash AFR and linkage correction function (helicopter only)
- [TIMER]: Timer setting
- [T1-T6 SETTING]: Control step amount and mode selection of the digital trim
- [DATA RESET]: Model memory set data reset (by item)
- [COND. HOLD]: Condition hold function (helicopter only)

SERVO MONITOR

Servo Test & Graph Display / Displays servo positions.

This is used for testing servo movement. “Moving Test” (repetition mode) and “Neutral Test” (fixed position mode) are available.

The “Neutral Test” is good for finding the neutral position of a servo horn.

- Select [SERVO MONITOR] at the linkage menu and call the setup screen shown below by pushing the EDIT button.

• Select the function name and return to the preceding screen by pushing the EDIT button.

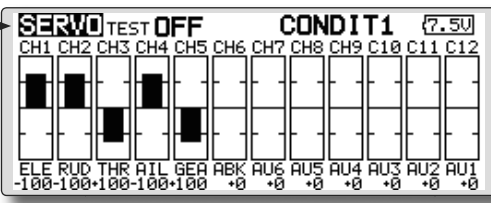

S1 button

EDIT dial

EDIT button

- Push the S1 button for 1 second to return to the home screen.
- Turn the EDIT dial to move on the screen.

*The display screen is an example. The screen depends on the model type.

Servo test operation

1. Use the EDIT dial to move the cursor to the [TEST] item and push the EDIT button to switch to the data input mode.

Select the test mode by turning the EDIT dial to the left or right and push the EDIT button.

[MOVING]: Mode which repeats operation of each servo

[NEUTRAL]: Mode which locks each servo in the neutral position

2. Use the EDIT dial to move the cursor to the [TEST] item and push the EDIT button to switch to the data input mode.

Select the [OFF] by turning the EDIT dial and push the EDIT button. Testing is stopped.

MODEL SELECT

The Model Selection function performs model addition, call, deletion, copy, and model name setting.

This function is used to load the settings of the desired model into the T12FG's memory.

The settings may be selected from either the transmitter's built-in memory or a SD card (32MB-1GB). Remember that up to 30 model memories are available in the transmitter.

The name of the model stored in the transmitter and the SD card may be changed. This can be very useful to tell different models settings apart. Each model name can be as long as 8 characters, and the model name

always appears in the display screen.

The Copy function is used to copy one set of model data into a second memory within the transmitter and the SD card. It may be used for getting a head-start on setting up models with almost the same settings (only differences need to be modified, instead of entering the complete model from scratch). Also, this function may be used to make a backup copy of a model setup before any changes are made.

- Select [MODEL SELECT] at the linkage menu and call the setup screen shown below by pushing the EDIT button.
- Select the function name and return to the preceding screen by pushing the EDIT button.

The diagram shows a screen titled "MODEL SELECT" with a model list containing "MODEL 1". To the right, it displays "1/1 (7.50)", "CURRENT: INTERNAL", and "MODEL 1". Below this, there are two options: "[INTERNAL]: transmitter memory" and "[MEM.CARD]: SD card". A rotary dial labeled "EDIT dial" is shown with an arrow pointing to the "INTERNAL" option. A button labeled "EDIT button" is also shown. A note says: "*The display screen is an example. The screen depends on the model type." Another note says: "*Push the S1 button for 1 second to return to the home screen." A third note says: "*Turn the EDIT dial to move on the screen." A label "(Model list)" points to the model list area.

Model call

*Model data saved at models other than the model currently used or saved on a SD card can be called.

1. Use the EDIT dial to move to the save destination ("INTERNAL" or "MEM.CARD") and push the EDIT button to switch to the data input mode.

Select the location which is to save the desired model by turning the EDIT dial to the left or right. Push the EDIT button.

[INTERNAL]: Transmitter memory
[MEM. CARD]: SD card

2. After using the EDIT dial to move the cursor to the desired model in the model list, push the EDIT button.
3. Use the EDIT dial to move to [SELECT].
4. Push the EDIT button. When a confirmation message is displayed and the EDIT button is pushed again, calling is complete.

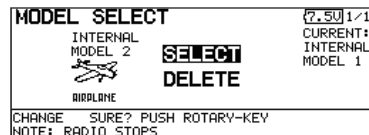

*Transmission stops and a send with new model confirmation message ("TRANSMIT?") appears.

5. To start transmission, use the EDIT dial to select [YES] and then push the EDIT button. To not transmit, select [NO] and push the EDIT button.

Model addition

*A new model can be added to the transmitter memory or SD card.

1. Use the EDIT dial to move the cursor to the save destination ("INTERNAL" or "MEM. CARD") and push the EDIT button to switch to the data input mode.

Select the save destination by turning the EDIT dial to the left or right. Push the EDIT button.

[INTERNAL]: Transmitter memory
[MEM. CARD]: SD card

2. Use the EDIT dial to move to [NEW].
3. Press the EDIT button. A confirmation message appears. Press the EDIT button again.

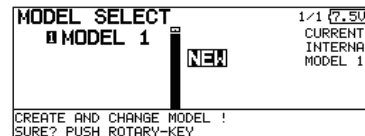

*The model type setup screen and frequency setup screen are automatically displayed. Confirm or change the model type and frequency.

*A starting transmission with new model confirmation message ("TRANSMIT") appears.

4. To start transmission, use the EDIT dial to select [YES] and then push the EDIT button. To not transmit, select [NO] and push the EDIT button.

*The added model appears in the model list.

Model deletion

*The model stored in the transmitter memory or a SD card can be deleted.

*The current model can not be deleted.

1. Use the EDIT dial to move the cursor to the save destination display ("INTERNAL" or "MEM. CARD") and push the EDIT button to switch to the data input mode.

Select the save destination by turning the EDIT dial to the left or right and push the EDIT button.

[INTERNAL]: Transmitter memory

[MEM. CARD]: SD card

2. Use the EDIT dial to move the cursor to the model you want to delete in the model list and then push the EDIT button.
3. Move the cursor to [DELETE].
4. Push the EDIT button. When a confirmation message is displayed and the EDIT button is pushed again, the model is deleted.

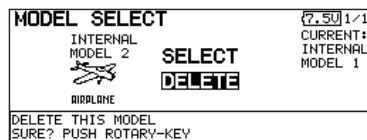

Model name change

*The current model's name can be changed.

1. Use the EDIT dial to select the current model in the model list and then push the EDIT button.
2. Use the EDIT dial to move to [RENAME].
3. Push the EDIT button.

*The model name setup screen is displayed.

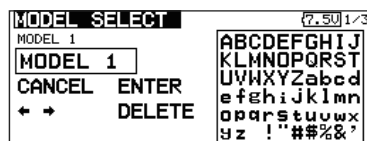

4. Change the model name as described below:

[Moving cursor in input box]

Select [←] or [→], and push the EDIT button.

[Deleting a character]

When [DELETE] is selected and the EDIT button is pushed, the character immediately after the cursor is deleted.

[Adding a character]

When a candidate character is selected from the character list and the EDIT button is pushed, that character is added at the position immediately after the cursor.

*A name of up to 8 characters long can be entered as the model name. (A space is also counted as 1 character.)

5. At the end of input, select [ENTER] and push

the EDIT button. (To terminate input and return to the original state, select [CANCEL] and push the EDIT button.)

Model copy

*A copy can be made of the current model.

1. Use the EDIT dial to select the current model in the model list and then push the EDIT button.
2. Move to [COPY] with the EDIT dial.
3. Push the EDIT button.

*The copy screen appears.

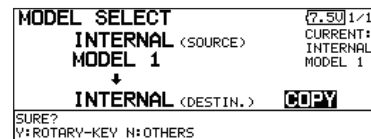

4. Use the EDIT dial to move to the copy destination position at the bottom of the screen and push the EDIT button to switch to the data input mode.

Select the save destination by turning the EDIT dial and push the EDIT button.

5. Use the EDIT dial to move to [COPY].
6. Push the EDIT button. When a confirmation message is displayed and the EDIT button is pushed again, the model data is copied.

MODEL TYPE

This function selects the model type from among airplane, helicopter, and glider.

Seven types of main wings and three types of tail wings are available for airplanes. Eight swash types are available for helicopters. Seven types of main wings and three types of tail wings are available for gliders. Functions and mixing functions necessary for each model type are set in advance at the factory.

Note: The Model Type function automatically selects the appropriate output channels, control functions, and mixing functions for the chosen model type.

When the Model Type Selection command is accessed, all of the data in the active memory is cleared (except the following swash type.) Be sure that you don't mind losing this data, or back it up to another memory using the copying functions.

When you change the helicopter swash type within the following each group, you can leave the setting data other than the SWASH function. In this case, confirmation screen appears. However, it is initialized when you change the swash type exceeding the group.

- Select [MODEL TYPE] at the linkage menu and call the setup screen shown below by pushing the EDIT button.

Swash type group A:
H-1, H-2, H-3, HR3, HN3, and HE3
Swash type group B:
H-4, H-4X

- Select the function name and return to the preceding screen by pushing the EDIT button.

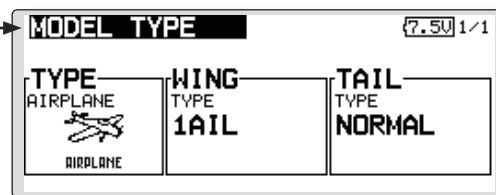

- Push the **S1** button for 1 second to return to the home screen.
- Turn the **EDIT** dial to move on the screen.

(The display screen is an example. The screen depends on the model type.)

Model type selection

1. Use the EDIT dial to move the cursor to the item you want to change and then call the selection screen by pushing the EDIT button.

"TYPE": Model type

"WING " (airplane/glider): Wing type

"TAIL" (airplane/glider): Tail type

"SWASH" (helicopter): Swash type

2. Use the EDIT dial to move the cursor to the type you want to change and select the type by pushing the EDIT button.

*When the model type was changed, the wing type, tail type, or swash type selection screens sequentially appear according to the model. Finally, the blinking confirmation message "MODEL TYPE CONFIRMATION" appears.



3. Push the EDIT button to execute the change. (Operate the EDIT dial or S1 button to stop the change.)

*The model types which are displayed (which can be selected) depend on the type of receiver used. For instance, for the R149DP, only model types compatible with CH8 can be selected. See Servo Connection by Model Type.

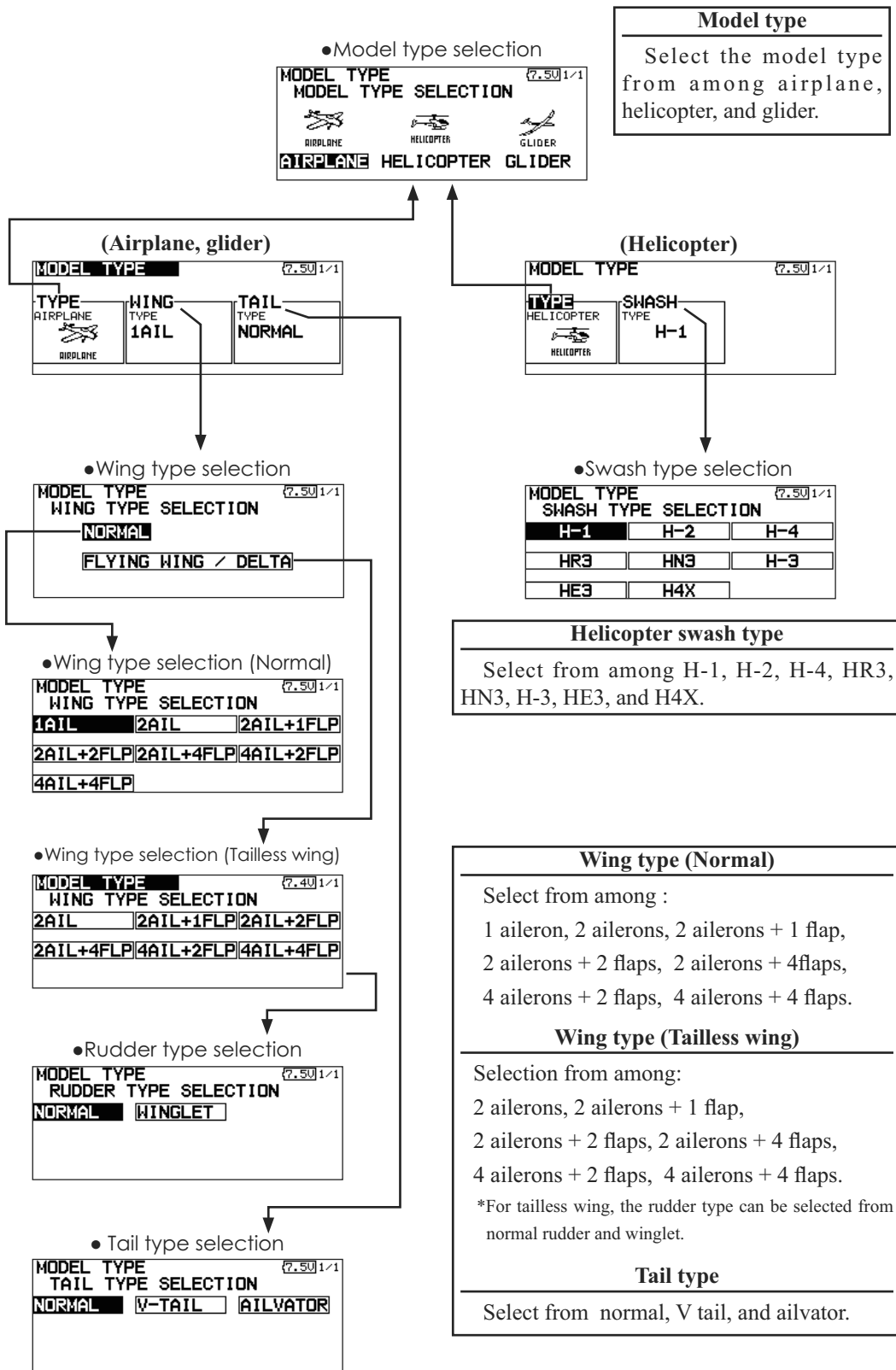

Model type selection (Airplane, Glider)

•Wing type (Normal)

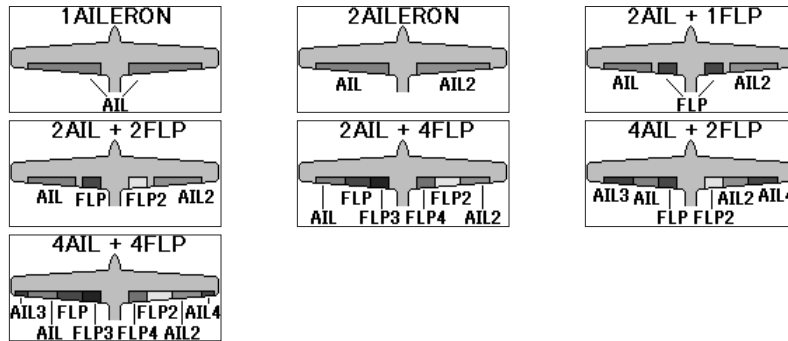

•Wing type (Tailless wing)

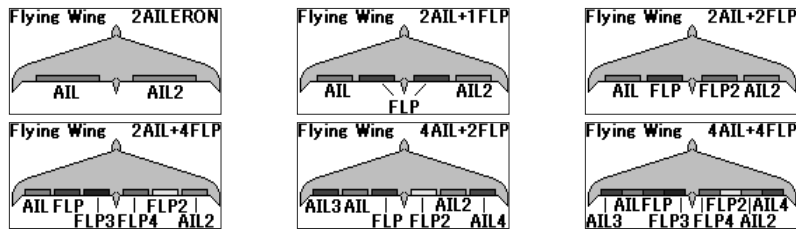

•Rudder type

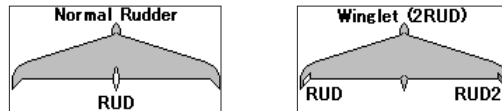

•Tail type

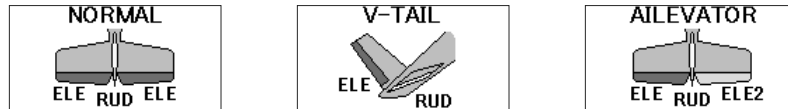

Model type selection (Helicopter)

•Swash type

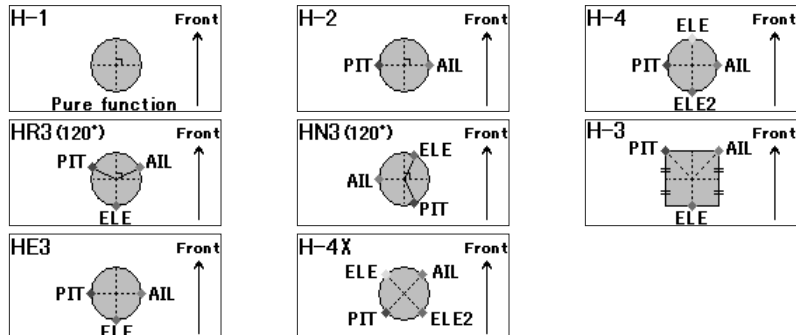

Frequency setting

The T12FG transmitter uses a synthesizer system. Its frequency can be changed within the range of the frequency band of the module used.

The frequency of the R5114DPS receiver is set from the transmitter. Use a receiver matched to the frequency band of the transmitter.

Receiver ID code

When the R5114DPS receiver (PCM-G3 receiver) is used, the ID code located on the back of the receiver case must be entered.

*When two receivers are used with a large model, etc., enter the 2nd receiver ID also.

Modulation mode selection

With the T12FG, 3 modulation modes (PCM-G3/PCM1024/PPM (FM)) can be selected. Select the modulation mode matched to the type of receiver used.

- Select [FREQUENCY] at the linkage menu and call the setup screen shown below by pushing the EDIT button.

• Select the function name and return to the preceding screen by pushing the EDIT button.

(7.50) 1/1

FREQUENCY

BAND No. (FREQ. CH) 17 (72.130MHz)

FREQ. BAND 72MHz AMERICA

MODULATION PCM-G3 (MODE A (SK))

RECEIVER ID RX1 00001001 RX2 NO USE

S1 button



EDIT dial



EDIT button

- Push the S1 button for 1 second to return to the home screen.
- Turn the EDIT dial to move on the screen.

Frequency switching method

For a description of the frequency switching and ID setting methods, refer to the procedure given in the Basic Operation section.

Modulation scheme (Modulation) change

1. Use the EDIT dial to move the cursor to the "MODULATION" item and push the EDIT button.

*The modulation selection screen appears.

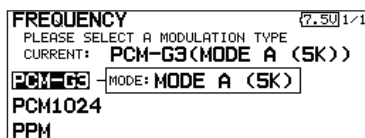

2. Use the EDIT dial to select the mode and push the EDIT button.

*The confirmation message "MODUL.TYPE IS CHANGED. SURE?" appears.

3. When the EDIT button is pressed again, the mode is changed.

*Transmission stops and a transmit or do not transmit in the new mode confirmation message "TRANSMIT?" appears.

PCM-G3 communication mode selection

Two types of PCM-G3 communication modes can be selected. (Mode A and Mode B)

Mode A is conventional mode and displays the maximum performance of the servo response to stick operation (recommended.) Mode B is a mode with enhanced communication quality. For the interference characteristic, ModeB is better than ModeA. In communication mode B, the servo response to stick operation is approximately 20% lower than that of mode A.

Choose the mode matched to the usage environment.

Compatible receiver:

Mode A: R5014DPS and R5114DPS

Mode B: R5114DPS (The R5014DPS is not Mode B compatible.)

4. To start transmission, select [YES] with the EDIT dial and push the EDIT button. To not transmit, select [NO] and push the EDIT button.

*When the mode is changed from the PCM-G3 mode to another mode and the number of channels is insufficient due to the wing type used, the mode cannot be changed.

Receiver ID code input

*Input the 8-digit ID number indicated on the receiver case.

1. Use the EDIT dial to select [RECEIVER ID] and push the EDIT button. The receiver ID code setup screen appears.

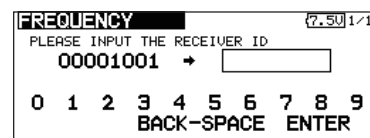

2. Use the EDIT dial to select the candidate character of the first digit and push the EDIT button. Sequentially set the 8-digit number.

*If you make a mistake, select [BACK SPACE] with the EDIT dial and erase the incorrect digit by pressing the EDIT button.

5. At the end of input, select [ENTER] and push the EDIT button.

*Once the ID code is set, re-setting is unnecessary as long as the receiver is not changed.

PCM-G3 communication mode selection

1. Use the EDIT dial to move the cursor to the "MODULATION" item and push the EDIT button.

*The mode selection screen appears.

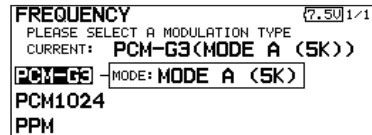

2. Use the EDIT dial to select the [MODE] item and push the EDIT button and push the EDIT button to switch to the data input mode.
3. Use the EDIT dial to select the mode and push the EDIT button.

*The communication mode is changed.

⚠ WARNING

- ! When flying after frequency change, emit radio waves only after verifying the frequency.

*Also change the frequency clip. Emitting radio waves without verification is extremely dangerous.

FUNCTION

Channel assignment of each function can be changed.

When you select model and wing (swash) types, you will find that the optimized combinations of servo output channels and functions have been already preset. If you would like, you can freely change combinations of servo output channels, functions (aileron, elevator, etc), and input controllers (sticks, switches, trim levers and trim switches).

*You can also assign the same function to multiple servo output channels such as assigning elevator function to CH2 and CH3.

Note: In PCMG3 mode, combinations of three channels such as CH 1 through CH 3, CH 4 through CH 6, CH 7 through CH 9 and CH 10 through CH 12 work simultaneously. Futaba recommends that you use the standard optimized default combinations of channels and functions in order to minimize servo delay when you use multiple servos to control models such as swash mode helicopters and dual elevator airplanes or flaperon airplanes.

VC1~VC4 (virtual channels)

These four channels can be set as virtual functions that do not have servo output channels. You can freely change combinations between functions (aileron, elevator, etc) and input controllers (sticks, switches, trim levers and trim switches).

Servo Output Channels

For PCMG3 mode, you can set twelve linear channels and two digital channels. For PCM1024 mode, you can set eight linear channels and one digital channel. For PPM mode, you can set only eight linear channels.

*DG1/2 (digital channels)

This channel can be used as switch channels. You can freely change combinations between servo output channels and input controllers (sticks, switches, trim levers and trim switches).

- Select [FUNCTION] at the linkage menu and call the setup screen shown below by pushing the EDIT button.

FUNCTION		CONDIT1	7.50 1/5
CH	FUNCTION	CONTROL	TRIM
1	ELEVATOR	J3	T3 COMB.
2	RUDDER	J4	T4 COMB.
3	THROTTLE	J2	T2 COMB.
4	AILERON	J1	T1 COMB.

- Trim operation mode
- "COMB": Combination mode
- "SEPAR": Separate mode
- Push the S1 button to call next page.
- Push the S1 button for 1 second to return to the home screen.
- Turn the EDIT dial to move on the screen.

(The display screen is an example. The screen depends on the model type.)

Function change

1. Use the EDIT dial to move the cursor to the "FUNCTION" item of the channel you want to change and push the EDIT button.
 - *The function selection screen is displayed.
2. Use the EDIT dial to move the cursor to the function name you want to set and push the EDIT button.
 - *The function name blinks.
3. Push the EDIT button to execute the change. (When you want to cancel this operation, operate the EDIT dial or S1 button.)
 - *Multiple channels can be assigned to one function.

Operation control change

1. Use the EDIT dial to move the cursor to the "CONTROL" item of the channel you want to change and push the EDIT button.
 - *The control selection screen is displayed.

HARDWARE SEL.		CONDIT1	7.50 1/1
HARDWARE LIST			
J1	SA	SE	LD T1 T5
J2	SB	SF	RD T2 T6
J3	SC	SG	LS T3 --
J4	SD	SH	RS T4

2. Use the EDIT dial to move the cursor to the control you want to change, and push the EDIT button.
 - *The same control can be assigned to multiple channels.
 - *The setting can be changed for each condition.
- After the set mode is changed from group mode [G] to single mode [S] at the control selection screen, only that condition setting is changed by control change; setting of other conditions remains the same.

Trim setting

Use the EDIT dial to move the cursor to the "TRIM" item of the channel you want to change and push the EDIT button.

*The trim setup screen is displayed.

HARDWARE SEL.		CONDIT1		(7.50) 1/1		
HARDWARE LIST				RATE		
J1	SA	SE	LD	T5	30%	
J2	SB	SF	RD	T2	T6	MODE
J3	SC	SG	LS	T3	--	NORMAL
J4	SD	SH	RS	T4		

The following items can be set at the trim setup screen:

*The setting can be changed for each condition.

After the set mode is changed from group mode [G] to single mode [S] at the control selection screen, only that condition setting is changed by control change; setting of other conditions remains the same.

Trim selection

Use the EDIT dial to move the cursor to the trim, lever, etc. you want to set and push the EDIT button.

*The setting can be changed.

Trim rate setting

Use the EDIT dial to move the cursor to the [RATE] item and push the EDIT button to switch to the data input mode.

Set the trim rate by turning the EDIT dial.

Initial value: +30%

Adjustment range : 0~150%

(When the EDIT button is pushed for 1 second, the trim rate is reset to the initial value.)

Push the EDIT button to end adjustment and return to the cursor move mode.

Trim mode selection

Use the EDIT dial to move the cursor to the [TRIM MODE] item and select the trim mode by turning the EDIT dial.

[NORM]: Normal mode. Normal trim (parallel shift trim) operation.

[ATL]: ATL operation mode. Maximum change near center by operation normally used with throttle trim. Reverse is also possible.

[NORM]/[REV] selection is possible at the "ATL REV" item.

[CENTER]: Maximum change near center by center trim operation.

The Sub-Trim function is used to set the servo neutral position, and may be used to make fine adjustments to the control surface after linkages and pushrods are hooked up. When you begin to set up a model, be sure that the digital trims are set to their center position.

- Select [SUB-TRIM] at the linkage menu and call the setup screen shown below by pushing the EDIT button.

- Select the function name and return to the preceding screen by pushing the EDIT button.

SUB-TRIM				7.50	1/2
CH FUNCTION			CH FUNCTION		
1 ELEVATOR		+0	5 GEAR		+0
2 RUDDER		+0	6 AIR BRAKE		+0
3 THROTTLE		+0	7 AUXILIARY6		+0
4 AILERON		+0	8 AUXILIARY5		+0



- Push the **S1** button to call next page.
- Push the **S1** button for 1 second to return to the home screen.
- Turn the **EDIT** dial to move on the screen.

(The display screen is an example. The screen depends on the model type.)

Sub trim adjustment

1. Use the EDIT dial to move the cursor to the channel you want to adjust and push the EDIT button to switch to the data input mode.
2. Adjust by turning the EDIT dial.
 - Initial value: 0
 - Adjustment range: -240~+240 (steps)
 - (When the EDIT button is pushed for 1 second, sub trim is reset to the initial value.)
 - *Before sub trim adjustment, adjustment of the linkage so that control surfaces need not use sub trim as much as possible is very important.
3. Repeat this procedure for each channel.

SERVO-REVERSE

Use to reverse the throw direction.

Servo Reverse changes the direction of an individual servo's response to a control stick movement.

For CCPM helicopters, be sure to read the section on Swash AFR before reversing any servos. With CCPM helicopters, always complete your servo reversing prior to any other programming. If you use pre-built Airplane/Sailplane functions

that control multiple servos, it may be confusing to tell whether the servo needs to be reversed or a setting in the function needs to be reversed. See the instructions for each specialized function for further details. Always check servo direction prior to every flight as an additional precaution to confirm proper model memory, hook ups, and radio function.

- Select [SERVO REVERSE] at the linkage menu and call the setup screen shown below by pushing the EDIT button.

- Select the function name and return to the preceding screen by pushing the EDIT button.

SERVO REVERSE						(7.50) 1/2
CH	FUNCTION	MODE	CH	FUNCTION	MODE	
1	ELEVATOR	NORM	5	GEAR	NORM	
2	RUDDER	NORM	6	AIR BRAKE	NORM	
3	THROTTLE	NORM	7	AUXILIARY6	NORM	
4	AILERON	NORM	8	AUXILIARY5	NORM	



- Push the **S1** button to call next page.
- Push the **S1** button for 1 second to return to the home screen.
- Turn the **EDIT** dial to move on the screen.

(The display screen is an example. The screen depends on the model type.)

Servo reversing procedure

- *After linkage of a new model is complete, check whether or not each servo is connected to the correct channel.
 - *Next, determine whether you need to reverse any channels by moving each stick.
1. Use the EDIT dial to move the cursor to the channel you want to reverse and push the EDIT button to switch to the data input mode.
 2. Turn the EDIT dial and change the display to [REVERSE] (or [NORMAL]).
 - *The display blinks.
 3. When the EDIT button is pushed, servo operation is reversed. (Operate EDIT dial or S1 button to stop reversal.)
 - *Repeat the operation above for each channel that must be reversed.

FAIL SAFE

Sets the servos operating position when transmitter signals can no longer be received or when the receiver battery voltage drops.

The Failsafe function may be used to set up positions that the servos move to in the case of radio interference.

This function only works with G3 or PCM receivers (FM receivers do not have failsafe capability).

You may set either of two positions for each channel: Hold, where the servo maintains its last commanded position, or Failsafe, where each servo moves to a predetermined position. You may choose either mode for each channel.

The T12FG system also provides you with an advanced battery monitoring function that warns you when the receiver battery has only a little power remaining. In this case, each servo is moved to the defined failsafe position (PCM1024: CH3 only.) The battery failsafe may be released by operating a predefined control on the transmitter (default is throttle), **do not continue to fly, land as soon as possible**. Remember, if the predefined

control suddenly moves to a position you did not command, land at once and check your receiver battery.

Defines servo position when signals are lost and when receiver battery voltage becomes low.

⚠ WARNING

! For safety, always set the fail safe functions.

- Especially set the throttle channel fail safe function so that the servo moves to the maximum slow side for airplanes and to the slow side from the hovering position for helicopters. Crashing of the model at full high when normal radio waves cannot be received due to interference, etc., is very dangerous.
- If fail safe is reset by throttle stick, it may be mistaken for an engine malfunction and will be reset at throttle slow and the model will continue to fly. If you have any doubts, immediately land.

- Select [FAIL SAFE] at the linkage menu and call the setup screen shown below by pushing the EDIT button.

- Select the function name and return to the preceding screen by pushing the EDIT button.

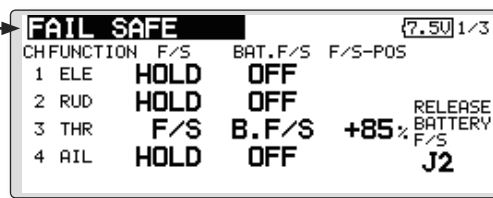

(The display screen is an example. The screen depends on the model type.)

- Push the **S1** button to call next page.
 - Push the **S1** button for 1 second to return to the home screen.
 - Turn the **EDIT** dial to move on the screen.
- 

Fail safe setting procedure

1. Use the EDIT dial and move the cursor to the "F/S" item of the channel you want to set and push the EDIT button to switch to the data input mode.

2. Display [F/S] by turning the EDIT dial to the left.

*The display blinks.

3. Push the EDIT button. (Operate EDIT dial or S1 button to stop setting.)

*The channel switches to the F/S mode.

4. Move the cursor to the "F/S-POS" item by turning the EDIT dial to the right.

Hold the corresponding stick, knob, slider, etc. in the position you want the servo to move to when the fail safe function is activated and push the EDIT button for 1 second.

*The set position is displayed in percentage.

*When you want to return that channel to the hold mode, use the EDIT dial to move the cursor to the "F/S" item and push the EDIT button to switch to the data input mode. Display [HOLD] by turning the EDIT dial to the right and then change the mode by pushing the EDIT button.

Battery fail safe setting procedure

Battery fail safe can be set for each channel by the same method as the fail safe setting procedure. Select and set the "BAT.F/S" item.

[B.F/S]: Battery fail safe function ON

[OFF]: Battery fail safe function OFF

Battery fail safe release switch setting

This function temporarily releases the battery fail safe function for the fuselage to recover after the battery fail safe function was activated by a drop in the receiver battery voltage. This setting selects the switch which releases the battery fail safe function.

1. Use the EDIT dial to move the cursor to the [RELEASE BATTERY F/S] item.

2. Push the EDIT button.

*The switch selection screen is called.

*For a detailed description of the switch selection and ON/OFF direction setting method, see [Switch Setting Method] at the back of this manual.

END POINT

Sets the travel, limit point, and speed of each servo.

The End Point function adjusts the left and right servo throws, generates differential throws, and will correct improper linkage settings.

The Travel rate can be varied from 30% to 140% in each direction on channels 1 to 12. Also, the Limit point where servo throw stops may be varied from 0% to 155%.

NOTE: The Servo Speed setting is used to set the servo delay for each channel, from channel 1 to channel 12. The system uses the programmed speed (delay) to slow down servo position changes. The Servo Speed setting can be varied from 0 to 27 in each channel.

- Select [END POINT] at the linkage menu and call the setup screen shown below by pushing the EDIT button.

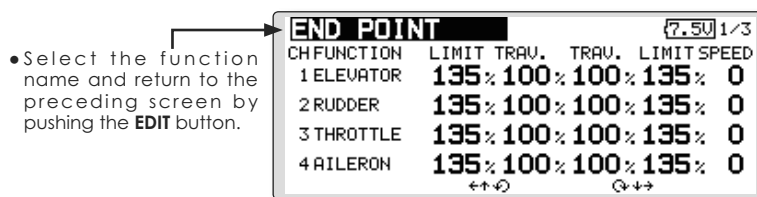

- Push the S1 button to call next page.
- Push the S1 button for 1 second to return to the home screen.
- Turn the EDIT dial to move on the screen.

(The display screen is an example. The screen depends on the model type.)

Servo travel adjustment

1. Use the EDIT dial to move the cursor to the "TRAV." item of the channel you want to adjust and push the EDIT button to switch to the data input mode.
2. Turn the EDIT dial to adjust the rate.
Initial value: 100%
Adjustment range: 30%~140%
(When the EDIT button is pushed for 1 second, the rate is reset to the initial value.)
Push the EDIT button to end adjustment and return to the cursor move mode.
3. Repeat this procedure for each rate.

Limit point adjustment

1. Use the EDIT dial to move the cursor to the "LIMIT" item of the channel you want to adjust and push the EDIT button to switch to the data input mode.
2. Turn the EDIT dial to adjust the limit point.
Initial value: 135%
Adjustment range: 0%~155%
(When the EDIT button is pushed for 1 second, the limit point is reset to the initial value.)
Push the EDIT button to end adjustment and return to the cursor move mode.
3. Repeat this procedure for each limit point.

Servo speed setting

1. Use the EDIT dial to move the cursor to the "SPEED" item of the channel you want to adjust and push the EDIT button to switch to the data input mode.
2. Turn the EDIT dial to adjust the servo speed.
Initial value: 0
Adjustment range: 0~27 (steps)
(When the EDIT button is pushed for 1 second, the servo speed is reset to the initial value.)
Push the EDIT button to end adjustment and return to the cursor move mode.
3. Repeat this procedure for each channel.

THROTTLE CUT

Stops the engine safely and easily. (airplane and helicopter only)

Throttle cut provides an easy way to stop the engine, by flipping a switch with the throttle stick at idle. The action is not functional at high throttle to avoid accidental dead sticks. The switch's location and direction must be chosen, as it defaults to NULL.

- Select [THROTTLE CUT] at the linkage menu and call the setup screen shown below by pushing the EDIT button.

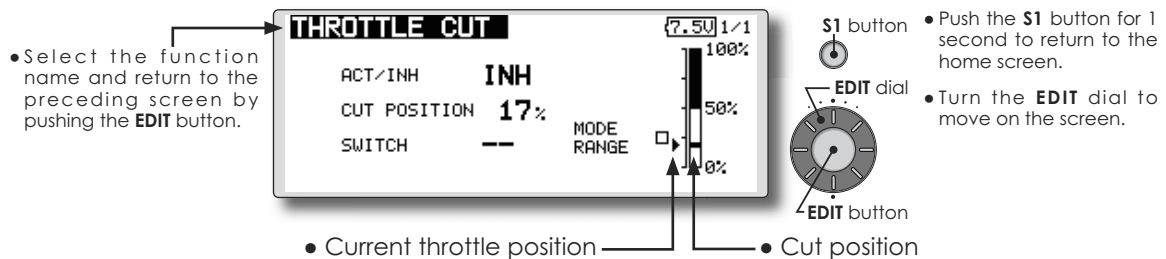

Throttle cut setting procedure

*Perform the following settings before using the EDIT dial to move the cursor to the item to be set.

1. Activate the function:

Move the cursor to the [ACT/INH] item and push the EDIT button to switch to the data input mode.

Turn the EDIT dial to the left until the blinking changes from "INH" to "ACT" and then push the EDIT button.

2. Switch setting:

Move the cursor to the [SWITCH] item and call the switch setup screen by pressing the EDIT button and select the switch and ON direction.

(For a detailed description of the setting method, see [Switch Setting Method] at the back of this manual.)

3. Throttle cut position setting:

Move the cursor to the [CUT POSITION] item and push the EDIT button to switch to the data input mode.

Adjust the servo operation position at throttle cut operation by turning the EDIT dial to the left or right.

Initial value: 17%

Adjustment range: 0%~50%

(When the EDIT button is pressed for 1 second, the servo operation position is reset to the initial value.)

Push the EDIT button to end adjustment and return to the cursor move mode.

*With the selected cut switch ON and the throttle stick at idle; adjust the rate until the engine consistently cuts off.

However, be sure that the throttle linkage is not pulled too tight and unreasonable force is not applied to the servo.

IDLE DOWN

Lowers the engine idling speed.(airplane and helicopter only)

The Idle Down function lowers the engines idle by flipping a switch with the throttle stick at idle. The action is not functional at high throttle to avoid accidental dead sticks. The switch's location and direction must be chosen, as it defaults to NULL.

- Select [IDLE DOWN] at the linkage menu and call the setup screen shown below by pushing the EDIT button.

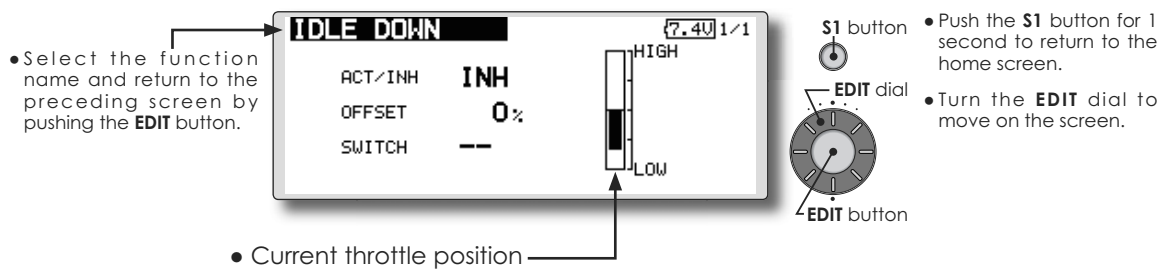

Idle down setting procedure

*Perform the following settings after using the EDIT dial to move the cursor to the item you want to set.

1. Activate the function:

Move the cursor to the [ACT/INH] item and push the EDIT button to switch to the data input mode.

Switch the blinking from "INH" to "ACT" by turning the EDIT dial to the left and then push the EDIT button.

2. Switch setting:

Move the cursor to the [SWITCH] item, call the switch setup screen by pushing the EDIT button, and select the switch and ON direction.

(For a detailed description of the setting method, see [Switch Setting Method] at the back of this manual.)

3. Offset rate setting:

Move the cursor to the [OFFSET] item and push the EDIT button to switch to the data input mode.

Adjust the servo offset rate at idle down operation by turning the EDIT dial to the left or right.

Initial value: 0%

Adjustment range: 0%~100%

(When the EDIT button is pushed for 1 second, the offset rate is reset to the initial value.)

*Maximum offset amount is near maximum slow.

Push the EDIT button to end adjustment and return to the cursor move mode.

SWASH RING

Limits the swash plate travel to within a fixed range. (Helicopter only)

This function limits the swash travel to within a fixed range to prevent damaging of the swash linkage by simultaneous operation of the ailerons and elevators. It is effective in 3D aerobatics which use a large travel.

- Select [SWASH RING] at the linkage menu and call the setup screen shown below by pushing the EDIT button.
- When the swash ring function is activated, a circle is displayed in the operating range display area and the rate input box is displayed. Stick operation is limited to within the area of this circle.
- Select the function name and return to the preceding screen by pushing the EDIT button.
- The operating range display area: The vertical direction shows the elevator travel. The Horizontal direction shows the aileron travel.
- The marker shows the stick position.
- Push the **S1** button for 1 second to return to the home screen.
- Turn the **EDIT** dial to move on the screen.

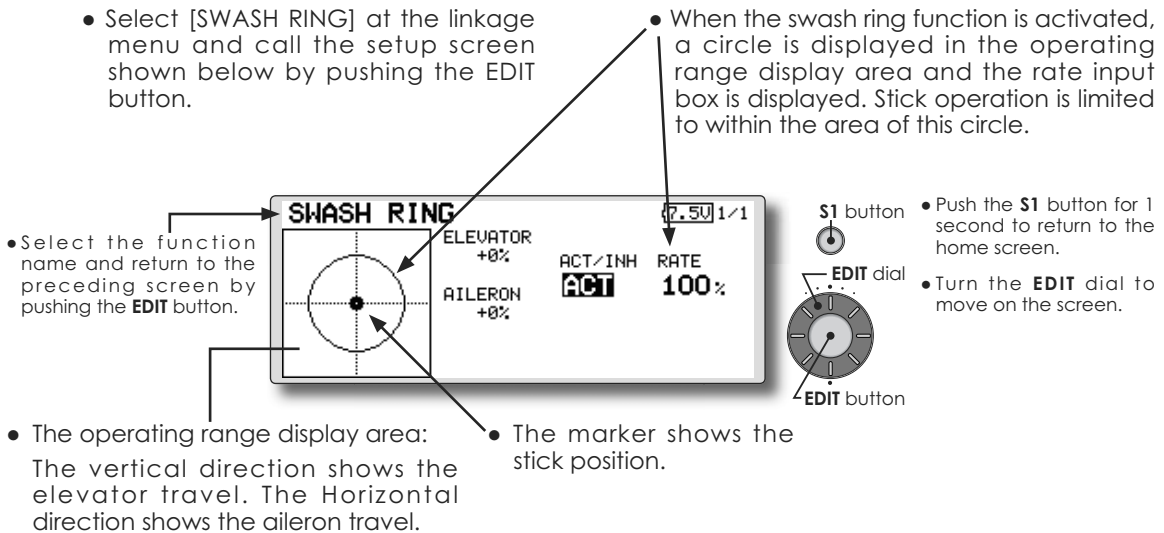

Swash ring setting procedure

*Perform the following settings after using the EDIT dial to move the cursor to the item you want to set.

1. Activate the function:

Move the cursor to the [ACT/INH] item and push the EDIT button to switch to the data input mode.

Switch the blinking from "INH" to "ACT" by turning the EDIT dial to the left and then push the EDIT button.

2. Rate setting:

Use the EDIT dial to move the cursor to the [RATE] item push the EDIT button to switch to the data input mode.

Use the EDIT dial to set the rate.

Initial value: 100%.

Adjustment range: 50 to 200%.

*Adjust the rate to maximum swash tilt.

(When the EDIT button is pushed for 1 second, the rate is reset to the initial value.)

Push the EDIT button to end adjustment and return to the cursor move mode.

Neutral Point

At your linkages, if the servo horn deviates from a perpendicular position at neutral, the linkage compensation functions in this menu may not compensate effectively. To correct this use the Neutral Point function. This will move the neutral point of the servos to the actual perpendicular position. However, this adjustment changes only the axis point of the compensation functions in this menu, and does not affect the neutral position of other functions.

Swash AFR

Swash AFR function reduces/increases/reverses the rate (travel) of the aileron, elevator and collective pitch functions, by adjusting or reversing the motion of all servos involved in that function, only when using that function.

Mixing Rate

This compensation mixing is used to correct the tendency of the swash-plate for each control.

The following compensation mixing is possible; PIT to AIL, PIT to ELE, AIL to PIT, ELE to AIL, and ELE to PIT (HR3 mode.) It adjusts the swash-plate to operate correctly for each control using the corresponding compensation mixing.

Linkage Compensation

This compensation mixing is used to correct the tendency of the swash-plate for pitch control at low pitch and high pitch.

Speed Compensation

This function is used to cancel the reaction that is generated by the difference of the operation amount of each servo when the swash-plate moves.

- Select [SWASH] at the linkage menu and call the setup screen shown below by pushing the EDIT button.

- Select the function name and return to the preceding screen by pushing the EDIT button.

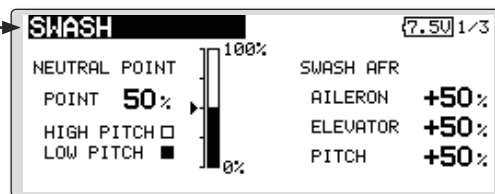

- Push the **S1** button to call next page.
- Push the **S1** button for 1 second to return to the home screen.
- Turn the **EDIT** dial to move on the screen.

*Before making the following settings, use the EDIT dial to move the cursor to the item you want to set.

Neutral point setting procedure

The neutral point becomes the correction standard point.

*Adjusting the servo horn so that the neutral point is near the 50% position makes the mixing amount small.

1. Neutral point setting

Move the cursor to the [POINT] item and hold the pitch operation so that the servo horn is at a right angle to the linkage rod and push the EDIT button for 1 second and read the neutral position.

*The neutral point can also be displayed by bar graph.

After reading the neutral point, use the other correction functions to make further adjustments.

Swash AFR setting procedure

The swash AFR function makes adjustments so that the servos travel the specified amount by [AILERON], [ELEVATOR], and [PITCH] operation.

1. Use the EDIT dial to move the cursor to the function you want to adjust and push the EDIT button to switch to the data input mode.

2. Adjust the AFR rate by turning the EDIT dial to the left or right.

Initial value: +50%

Adjustment range: -100%~+100%

(When the EDIT button is pushed for 1 second, the AFR rate is reset to the initial value.)

Push the EDIT button to end adjustment and return to the cursor move mode.

Mixing rate setting procedure

The HR-3 is taken as an example to describe mixing rate setting. Mixing applied in other swash modes is different, but the setting procedure is the same.

SWASH		7.50 2/3	
MIXING RATE			
MIXING	←← ⊕ ⊕ →→	MIXING	←← ⊕ ⊕ →→
PIT→AIL	100% 100%	AIL→PIT	100% 100%
PIT→ELE	100% 100%	ELE→AIL	50% 50%
		ELE→PIT	50% 50%

*Set the throttle stick to the preset neutral point. Adjust the length of the linkage rod so that the swash plate is horizontal at this position.

*The sub trim function can be used to make small adjustments.

*Adjust so that the pitch curve is a straight line and pitch operation is maximum.

*When making the following setting, use the EDIT dial to move the cursor to the item you want to set and push the EDIT button to switch to the data input mode. Push the EDIT button to end adjustment and return to the cursor move mode.

1. Adjustment at aileron operation [AIL to PIT]

Adjust the AIL to PIT rate so there is no interference in the elevator or pitch direction when the aileron stick is moved to the left and right.

*Adjust by turning the EDIT dial to the left or right.

*The left and right sides can be adjusted individually.

2. Adjustment at elevator operation [ELE to AIL]/[ELE to PIT]

Adjust the ELE to AIL and ELE to PIT rates so there is no interference in the aileron or pitch direction when the elevator stick is moved up and down.

*Adjust by turning the EDIT dial to the left and right.

*The up and down sides can be adjusted individually.

3. Adjustment at pitch operation [PIT to AIL][PIT to ELE]

Adjust the PIT to AIL and PIT to ELE rates so that the swash plate moves to the horizontal position when the throttle stick was moved to maximum slow and full high.

*Adjust by turning the EDIT dial to the left and right.

*The slow and high sides can be adjusted individually.

Linkage compensation setting procedure

*Perform linkage compensation setting after mixing rate setting.

*Linkage compensation compensates for interference by aileron operation with the elevator or elevator operation with the aileron at collective pitch control for Low pitch and Hi pitch.

SWASH		8.80 3/3	
LINKAGE COMPENSATION			
FUNCTION	DIR.	←← ⊕ ⊕ →→	←← ⊕ ⊕ →→
AILERON	+	0%	0%
ELEVATOR	+	0%	0%
SPEED COMPENSATION		0	

*When making the following setting, use the EDIT dial to move the cursor to the item you want to set and push the EDIT button to switch to the data input mode. Push the EDIT button to end adjustment and return to the cursor move mode.

1. Compensation at aileron operation [AILERON]

Set the throttle to the maximum slow position. Move the aileron stick to the left and right and adjust the aileron compensation amount so that interference in the elevator or pitch direction at that time is minimum.

*Adjust the EDIT dial to the left and right.

*The left and right sides can be adjusted individually.

*When the interference increases when the compensation amount was increased, make adjustments with the compensation direction [DIR] as "-".

2. Compensation at elevator operation [ELEVATOR]

Adjust the elevator compensation amount so that the aileron or pitch direction interference when the elevator stick was moved up and down is minimum.

3. Regarding steps 1 and 2 above, perform aileron and elevator compensation similarly at the full high side of the throttle stick also.

Speed compensation setting procedure

1. Use the EDIT dial to move the cursor to the "SPEED COMPENSATION" item and push the EDIT button to switch to the data input mode.

2. Set the throttle stick to the neutral point position. Quickly move the elevator stick and adjust the speed compensation amount [SPEED COMPENSATION] for minimum interference in the pitch direction.

*Adjust by turning the EDIT dial to the left and right.

Push the EDIT button to end adjustment and return to the cursor move mode.

The Timer function may be set for any desired time, i.e. engine run time, specified times for competitions, etc. Two independent timers are provided for your use. The timers are stored independently with each model, meaning that when you switch between model setups, the timer associated with the new model is brought up automatically.

The timers may be set to start and stop from the motion of any switch or stick. You may set the ON and OFF directions freely. Each timer has a capacity of up to 59 minutes 59 seconds.

- Select [TIMER] at the linkage menu and call the setup screen shown below by pushing the EDIT button.

• Select the function name and return to the preceding screen by pushing the EDIT button.

• Push the **S1** button for 1 second to return to the home screen.

• Turn the **EDIT** dial to move on the screen.

Timer setting

*Perform the following settings after using the EDIT dial to move the cursor to the item you want to set.

1. Up timer/down timer setting
Move the cursor to the [MODE] item and push the EDIT button to switch to the data input mode.
Select the mode by moving the EDIT dial to the left or right and push the EDIT button.
[UP]: Up timer
[DOWN]: Down timer
2. Timer time setting
Move the cursor to the [10]:[100] item and push the EDIT button to switch to the data input mode.
Set the time by turning the EDIT dial to the left or right.
[00]:[00]:[min]:[sec]
Push the EDIT button to end adjustment and return to the cursor move mode.
3. Switch setting
Move the cursor to the item of the switch you want to set, call the switch setup screen by pushing the EDIT button, and select the

Each timer may be set for count-down or count up operation with a target time.

If a target time is set and the timer reaches the set time, a buzzer sound for each count is generated.

Countdown timers sound one short beep during the last twenty seconds and two short beeps during the last ten seconds before reaching the target, then a long tone at the target time, and continue counting with displaying a minus (-) sign. Count-up timers also beep the last twenty and ten seconds, beep the target time, and keep counting upwards until shut down.

switch and ON direction.

[For a detailed description of the setting method, see [Switch Setting Method] at the back of this manual.]

[RESET SW]: Reset switch

[START SW]: Start switch

[STOP SW]: Stop switch

Timer operation

- Timer 1 and Timer 2 are started/stopped by pre-selected start/stop switch.
- To reset a timer, operate the pre-selected reset switch, or move the cursor to the [RESET] display on the timer screen and push the EDIT button.

T1-T6 SETTING

Digital trim settings

This function adjusts the digital trim's control step amount and operation mode (T1~T6.)

When the flight conditions are set, the trim operation can be coupled with among all the conditions which combination mode is selected.

- Select [T1-T6 SETTING] at the linkage menu and call the setup screen shown below by pushing the EDIT button.

• Select the function name and return to the preceding screen by pushing the EDIT button.

T1-T6 SETTING		CONDIT 1	7.50	1/1
	STEP	MODE	STEP	MODE
T1	4	COMB.	T4	4 COMB.
T2	4	COMB.	T5	4 COMB.
T3	4	COMB.	T6	4 COMB.

S1 button

EDIT dial

EDIT button

- Push the **S1** button for 1 second to return to the home screen.
- Turn the **EDIT** dial to move on the screen.

Control step amount setting

1. Use the EDIT dial to move the cursor to the [STEP] item and push the EDIT button to switch to the data input mode.

Set the control step amount by turning the EDIT dial.

Initial value: 4

Adjustment range: 1~200

(When the EDIT button is pushed for 1 second, the control step amount is reset to the initial value.)

*When the value is made large, the change per step becomes larger.

2. Push the EDIT button to end adjustment and return to the cursor move mode.

Separate/combination mode selection

1. Use the EDIT dial to move the cursor to the [SEPA./COMB.] item and change to blinking by turning the EDIT dial and select the mode by pushing the EDIT button.

[COMB]: Combination mode. The trim data are reflected at all the flight conditions.

[SEPAR]: Separate mode. Trim adjustment for each flight condition.

This function is designed to allow you to reset selected portions or all of the settings saved in the active model memory. You may individually choose to reset the following sets of data;

T1~T6:

Reset the digital trim setting.

*All the conditions, or the condition currently being displayed (the entire group for group setting), can be selected.

*The trim step amount and trim rate are not reset.

Model menu setting:

Resets all the functions in the Model Menu except Condition Select.

All model setting:

Resets all Linkage and Model Menu functions except for Frequency, Model Select, and Model Type.

- Select [DATA RESET] at the linkage menu and call the setup screen shown below by pushing the EDIT button.

- Select the function name and return to the preceding screen by pushing the **EDIT** button.

(7.50) 1/1

DATA RESET

T1-T6 (ALL CONDITION)

T1-T6 (CURRENT+GROUP COND.)

MODEL MENU SETTING

ALL MODEL SETTING



S1 button

EDIT dial

EDIT button

- Push the **S1** button for 1 second to return to the home screen.
- Turn the **EDIT** dial to move on the screen.

Data resetting method

1. Move the cursor to the item you want to reset and push the EDIT button.

*A confirmation message appears.

2. Execute reset by pushing the EDIT button again. (Operate EDIT dial or S1 button to stop resetting.)

[T1-T6 (ALL CONDITION)]: Resets only the T1-T6 (all conditions)

[T1-T6 (CURRRNT+GROUP COND.)]: Resets only the data of T1-T6 (condition in use and all the conditions set to group mode)

[MODEL MENU SETTING]: Resets all the functions in the model menu, except the condition selection functions.

[ALL MODEL SETTING]: Resets all the functions in the linkage menu and model menu except the frequency, model select, and model type functions.

This function may be used to fix the maximum speed of the engine so that you may adjust flight conditions when the engine is running. An alarm indicates that the function is operating. It will prevent the engine from racing dangerously when adjusting the Idle-Up settings.

While this function is active, the throttle servo position is fixed at the point where you operate when the function is activated. You must deactivate this function when you are through making adjustments.

The system will not allow you to activate/deactivate this function in either of the following states:

- When any of the flight condition switches are on.
- When the throttle stick is higher than the 1/3 point.

To activate/deactivate Condition hold:**(Home screen)**

1. Move the cursor to [CND HOLD].
2. Set the throttle stick lower than the 1/3 point.
3. Push the EDIT button to activate the condition hold function.

*When this function is active, "IS ON" appears at the right of the [CND HOLD] display at the left bottom of the screen.

(LINKAGE menu/MODEL menu)

1. Move the cursor to [COND. HOLD].
2. Set the throttle stick lower than the 1/3 point.
3. Push the EDIT button to activate the condition hold function.

*Operation is displayed at the bottom of the menu.

Function ON: "CND HOLD IS ON" is displayed.

Function OFF: "CND HOLD IS OFF" is displayed.

MODEL MENU (COMMON FUNCTIONS)

This section describes the AFR, program mixing, and other functions common to all model types.

Before setting the model data, use the Model Type function of the Linkage Menu to select the model type matched to the fuselage. When another model type is selected thereafter, the AFR, program mixing, and other setting data are reset.

The functions in the Model Menu can be set for each flight condition. When you want to use the system by switching the settings for each condition by switch, stick position, etc., use the Condition

Select function to add flight conditions. (Up to 8 conditions can be used)

Note: The T12FG is designed so that the airplane and glider (including EP glider) model types are compatible with aircraft of similar type wings. This section outlines the relationship between the functions common to airplanes and gliders, except some dedicated functions, and model type. The setting items depend on the number of servos and other differences according to the wing type used, but reread them. The setup screens in the instruction manual are typical examples.

- Select the [MODEL] at the home screen and call the model menu shown below by pushing the EDIT button.
- Use the EDIT dial to select the function you want to set and call the setup screen by pushing the EDIT button.

(Model Menu screen example)

*The Model Menu screen depends on the model type. This screen is for model type 4AIL+4FLP.

- Select the [MODEL MENU] and return to the home screen by pushing the EDIT button.

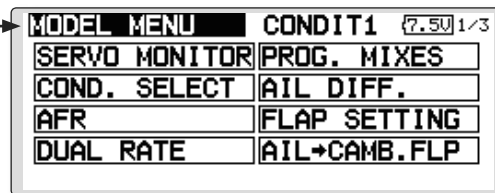

- Push the **S1** button to call next page.
- Push the **S1** button for 1 second to return to the home screen.
- Turn the **EDIT** dial to move on the screen.

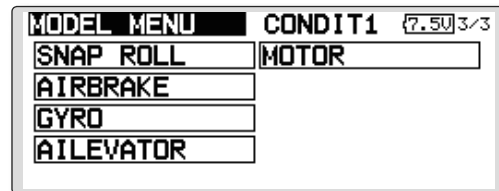
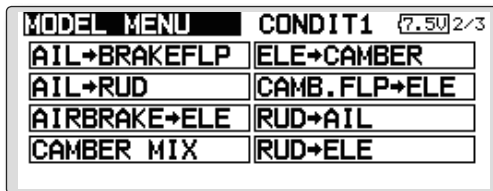

Model Menu functions (Common) list

•SERVO MONITOR

Servo test and servo position display (For a description of its functions, see the Linkage Menu section.)

•COND.SELECT

Flight conditions addition, deletion, copy, condition renaming, and condition delay can be set.

•AFR

Sets the angle and curve of all the operation functions.

•DUAL RATE

A D/R curve which can be switched with a switch, etc. can also be added.

•PROG. MIX

Program mixing which can be freely customized. Up to 10 mixes can be used for each condition.

CONDIT. SELECT

Flight condition's addition, deletion, copy, condition renaming, and condition delay can be set. [All model types]

The functions in the Model Menu can be used by switching the settings of up to 8 flight conditions by using the Condition Select function to add flight conditions. Add conditions, as required.

When you do not want to use the Condition Select function, this setting is unnecessary. In this case, use the flight conditions assigned at initial setting.

- Since switching by stick and lever position, in addition to ordinary toggle switch, is possible as the flight condition selector switch, this function can be linked with other operations.
- A Condition Delay function can be set. Unnecessary fuselage motion generated

when there are sudden changes in the servo positions and when there are variations in the operating time between channels during condition switching can be suppressed. The delay can be set for each channel.

When setting the delay function at the switching destination condition, the related function changes after a delay corresponding to the set amount.

- When multiple conditions were set, their operation priority can be freely changed.
- The condition name can be changed. The selected condition name is displayed on the screen. When a condition has been added, give it a name which can be easily confirmed.

- Select [CONDIT. SELECT] at the model menu and call the setup screen shown below by pushing the EDIT button.

(Currently selected condition name)

(Conditions List)

• Select the function name and return to the preceding screen by pushing the EDIT button.

• Push the **S1** button for 1 second to return to the home screen.

• Turn the **EDIT** dial to move on the screen.

*Perform the settings below after using the EDIT dial to move the cursor to the item you want to set.

Condition addition

1. Use the EDIT dial to move the cursor to any condition in the conditions list and push the EDIT button.

Move the cursor to the condition you want to add.

2. Move the cursor to [ADD] and push the EDIT button.

*Only the No. of the conditions which can be added is displayed.

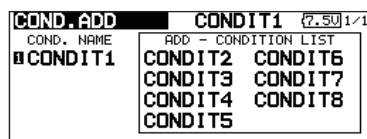

3. Add the condition by pushing the EDIT button again. Push the EDIT button to end adjustment and return to the cursor move mode.

4. Move the cursor to [SWITCH] item, call the switch setup screen by pushing the EDIT button, and select the switch and ON direction to be used in condition switching.

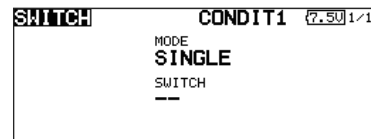

(For a detailed description of the setting method, see [Switch Setting Method] at the back of this manual.)

*The data (except the condition name) of the condition currently being used is copied to the added condition.

Condition deletion

1. Use the EDIT dial to move the cursor to the condition you want to delete in the conditions list and push the EDIT button.

*The number before the condition name become reverse-video to show that it is to be deleted.

2. Move the cursor to [REMOVE] and push the EDIT button.

*A confirmation message is displayed.

*Note that if initially operated up and down, the objective condition changes.

3. When the EDIT button is pushed again, the condition is deleted. (Operate the EDIT dial or S1 button to stop deletion.)

Push the EDIT button to end adjustment and return to the cursor move mode.

Condition name change

1. Use the EDIT dial to move the cursor to the condition you want to change in the conditions list.

*The number before the condition name become reverse-video to show that it is to be deleted.

2. Move the cursor to [RENAME] and push the EDIT button.

*The condition name setup screen appears.

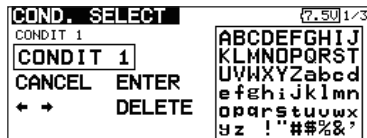

3. Change the condition name as described below:

[Moving cursor in input box]

Select [←] or [→], and push the EDIT button.

[Deleting a character]

When [DELETE] is selected and the EDIT button is pushed, the character immediately after the cursor is deleted.

[Adding a character]

When a candidate character is selected from the character list and the EDIT button is pushed, that character is added at the position immediately after the cursor.

*A name of up to 8 characters long can be entered as the condition name. (A space is also counted as 1 character.)

5. At the end of input, select [ENTER] and push the EDIT button. (To terminate input and return to the original state, select [CANCEL] and push the EDIT button.)

Condition copy

1. Use the EDIT dial to move the cursor to any condition in the conditions list and push the EDIT button.

2. Use the EDIT dial to move to [COPY].

3. Push the EDIT button.

*The copy screen appears.

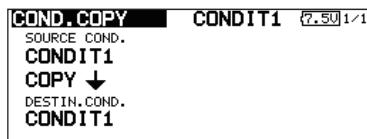

4. Use the EDIT dial to move the cursor to the "SOURCE COND." (copy source) item and push the EDIT button.

*The models already saved are displayed at the right side of the screen.

5. After using the EDIT dial to move the cursor to the copy source condition, push the EDIT button.

*The copy source condition is displayed at the "SOURCE COND." position.

6. Use the EDIT dial to move the cursor to

"DESTIN.CND." (copy destination) and push the EDIT button.

*The models already saved are displayed at the right side of the screen.

7. After using the EDIT dial to move the cursor to the copy destination condition, push the EDIT button.

*The copy destination conditions are displayed at the "DESTIN.COND." position.

8. Use the EDIT dial to move the cursor to [COPY] and push the EDIT button.

9. When the EDIT button is pushed again, copy is executed (Operate EDIT dial or S1 button to stop copying.)

Push the EDIT button to end adjustment and return to the cursor move mode.

Priority change

1. Use the EDIT dial to move the cursor to the condition whose priority you want to change in the condition list.

2. Move the cursor to [UP] or [DOWN] of [PRIORITY] and push the EDIT button. (The last condition becomes the highest priority.)

*The initial setting condition cannot be shifted. The priority is the lowest.

Condition delay setting

1. Use the EDIT dial to move the cursor to the condition you want to change in the condition list and push the EDIT button.

2. Move the cursor to [DELAY] and push the EDIT button.

*The condition delay setup screen appears.

COND. DELAY		CONDIT1 (2.50)1/4	
CH	FUNCTION	DELAY	GROUP
CH1	ELEVATOR	0	GROUP
CH2	RUDDER	0	GROUP
CH3	THROTTLE	0	GROUP
CH4	AILERON	0	GROUP

3. Use the EDIT dial to move the cursor to the "DELAY" item of the channel you want to set and push the EDIT button to switch to the data input mode.

Adjust the delay amount with the EDIT dial.

Initial value: 0

Adjustment range: 0~27 (maximum delay)

Push the EDIT button to end adjustment and return to the cursor move mode.

- The setting mode (group [GROUP]/single [SINGLE] mode) can be switched.

(For more information, see the description at the back of this manual.)

AFR function is used to adjust the throw and operation curve of the stick, lever, and switch functions (CH1 to CH12, and V1 to V4) for each flight condition. This is normally used after End Point has defined the maximum throw. When mixing is applied from one channel to another channel, both channels can be adjusted at the same time by adjusting the operation rate through the AFR function.

- Operation curve adjustment: Three types of curves (EXP1, EXP2, and POINT) can be selected. A maximum 17 points curve can be used for the point curve type. (Initial setting: 9 points) The number of points can also be increased and decreased and curves from complex curves to simple curves can be used.
- Operation speed adjustment: The operation speed of each function when the function is operated (including at flight condition switching) can be adjusted. The function operates smoothly at a constant speed corresponding to the set speed.

- Select [AFR] at the model menu and call the setup screen shown below by pushing the EDIT button.

• Select the function name and return to the preceding screen by pushing the **EDIT** button.

(Currently selected condition name)

[AFR/D/R]: Displays the currently selected rate (AFR/D/R).

- Push the **S1** button to call next page.
- Push the **S1** button for 1 second to return to the home screen.
- Turn the **EDIT** dial to move on the screen.

• Operation curve setting
(For a description of the setting method, see the description at the back of this manual.)

(Number of D/R curves set at the currently selected condition)

- Function selection
- Servo speed setting
(For a description of the setting method, see the description at the back of this manual.)
- Group/single mode switch (GROUP/SINGLE)
(For more information, see the description at the back of this manual.)

Function selection method

1. Use the **EDIT** dial to move the cursor to [FUNC.] and push the **EDIT** button to switch to the data input mode.
2. Select the desired function by turning the **EDIT** dial to the left or right, push the **EDIT** button.

*The setting mode (group [GROUP]/single [SNGLE] mode) can be switched (For more information, see the description at the back of this manual.)

D/R curves which can be switched by switch, etc. can be added. The curve can be adjusted by the AFR function.

- Up to 6 rates can be added for each condition.
- D/R is set for each condition and is not reflected at other conditions.
- D/R at the top of the D/R list has priority.

- Select [DUAL RATE] at the model menu and call the setup screen shown below by pushing the EDIT button.

- Select the function name and return to the preceding screen by pushing the **EDIT** button.

DUAL RATE		CONDIT1		7.50 1/2
D/R NAME	STATUS	FUNCTION	SWITCH	
1 D/R 1	INH	AILERON	---	
2 D/R 2	INH	AILERON	---	
3 D/R 3	INH	AILERON	---	
4 D/R 4	INH	AILERON	---	



- Push the **S1** button to call next page.
- Push the **S1** button for 1 second to return to the home screen.
- Turn the **EDIT** dial to move on the screen.

Dual rate adding

1. Move the cursor to the [INH] display of an unused D/R and push the EDIT button to switch to the data input mode.

Turn it off by turning the EDIT dial to the left and activate the D/R function by pushing the EDIT button.

2. Move the cursor to the "FUNCTION" item and push the EDIT button to switch to the data input mode.

Select the function by turning the EDIT dial and push the EDIT button.

3. Move the cursor to the [SWITCH] item and call the switch setup screen by pushing the EDIT button and select the switch and ON direction.

(For a detailed description of the setting method, see [Switch Setting Method] at the end of this manual.)

PROG. MIXES

Program mixing which can be freely customized. Up to 10 mixings can be used for each condition. [All model types]

Programmable mixing may be used to correct undesired tendencies of the aircraft, and it may also be used for unusual control configurations. Mixing means that the motion of a command channel, called the "master," is added to the motion of the mixed channel, called "slave."

You may choose to have the Master's trim added to the Slave channel response ("Trim" setting). The mixing curve can be changed so that the undesired tendencies can be corrected effectively by setting the EXP1/EXP2/POINT modes. The Delay function can be programmed for each rate. The Delay is used to change the rate smoothly when switching mixes. You may define Mixing ON/OFF switch, control or you may choose to

have mixing remaining on all the time. Mixing ON/OFF delay time can be adjusted.

The Programmable mixing includes a powerful link function, which allows Programmable mixing to be linked with the special mixing functions, or with other programmable mixing functions. The link function can be set up for Master and Slave channel individually.

The slave channel AFR mode (STK-STK mode) may be selected, where the slave channel AFR and D/R settings are observed when Link function is set. The knob for fine tuning can be set up for every mixing circuit. (Fine tune function)

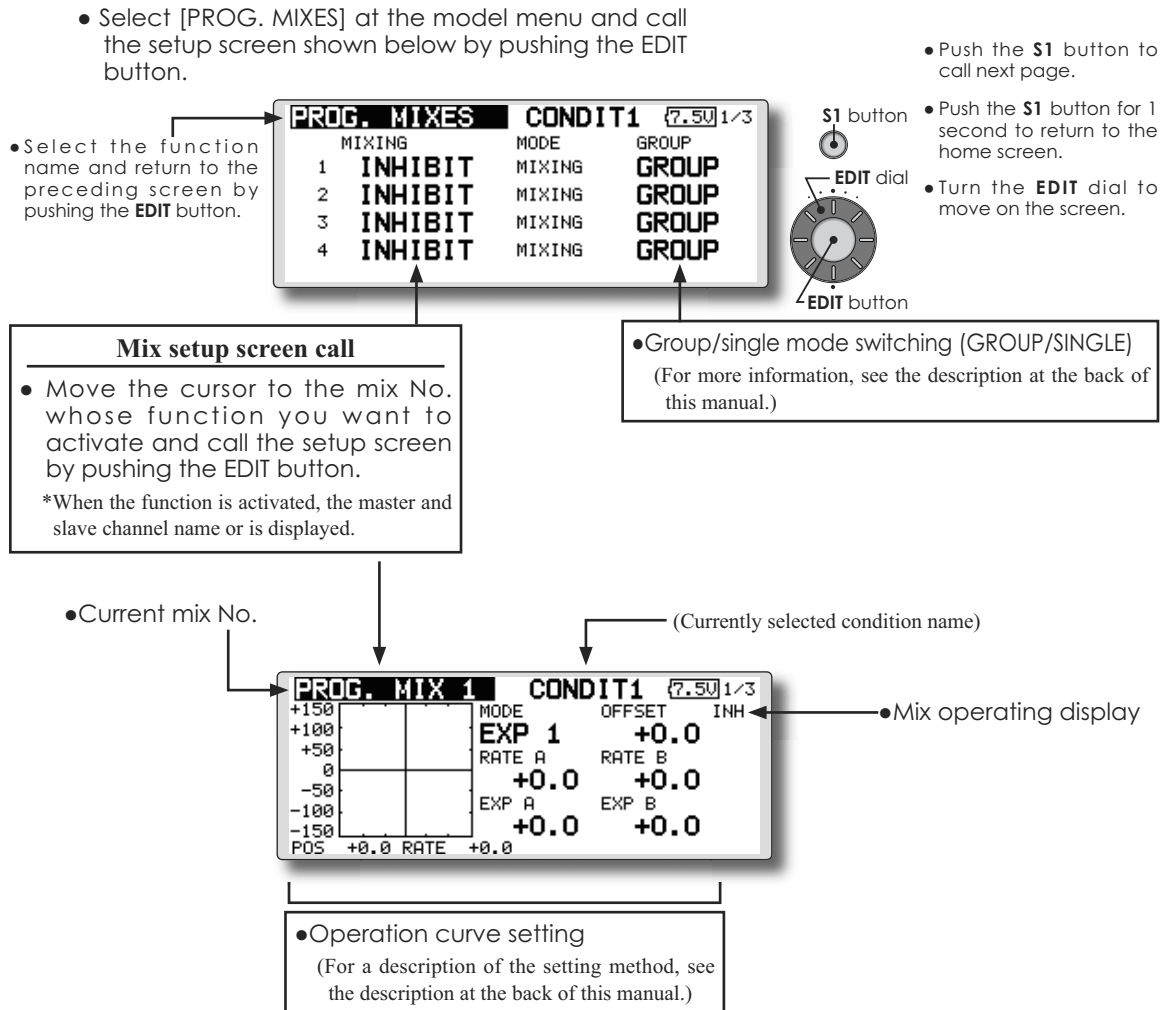

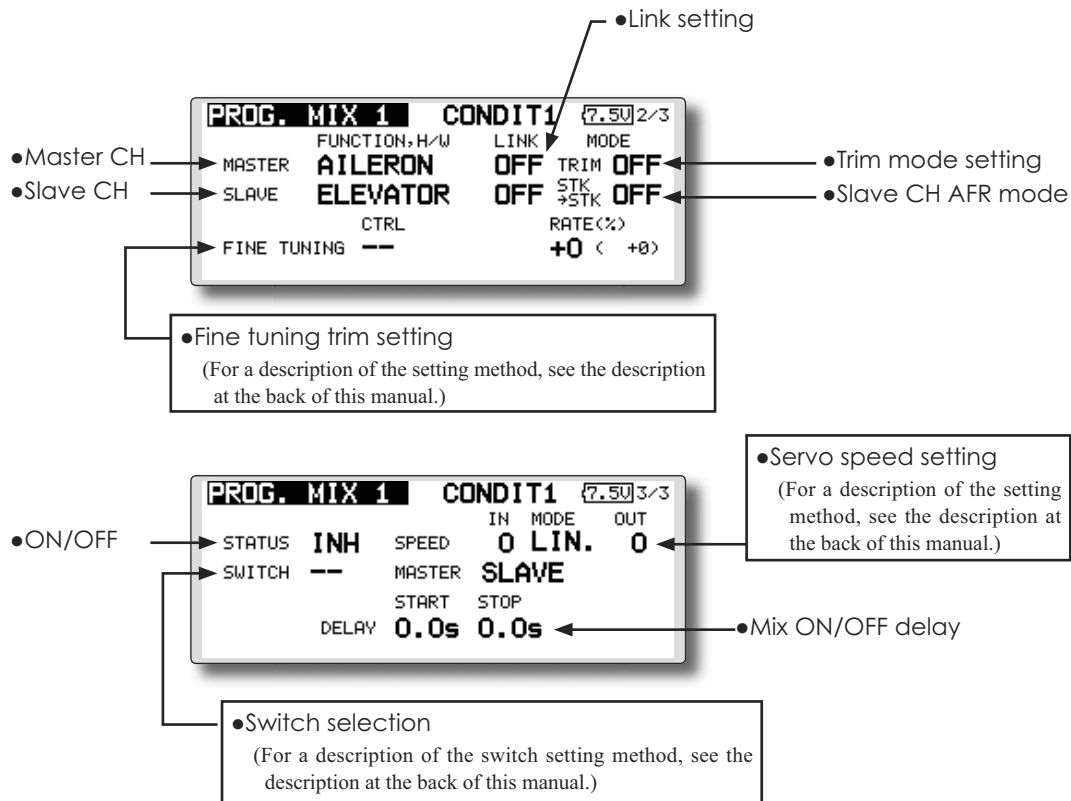

*Perform the settings below after using the EDIT dial to move the cursor to the item you want to set.

●Group/single mode selection

1. When you want to activate functions for only selected conditions, move the cursor to the [GROUP] item and push the EDIT button to switch to the data input mode.
2. Turn the EDIT dial to the left until [SINGLE] starts to blink and then push the EDIT button.

*The mode changes to the single mode [SINGLE].
 *When using common settings at each conditions, remain in the [GROUP] mode.

●Activate the function.

1. Move the cursor to [INH] and push the EDIT button to switch to the data input mode.
2. Turn the EDIT dial to the left until [ACT] starts to blink and then push the EDIT button.

*The function is activated. (ON or OFF display)
 *ON/OFF switch and mix rate are not set even through the function is activated.

●ON/OFF switch setting

Move the cursor to the [SWITCH] item, call the switch setup screen by pushing the EDIT button, and select the switch and ON direction.

(For a description of the setting method, see [Switch Setting Method] at the back of this manual.)

*Always on when [--].

●Master channel setting

1. Move the cursor to the [FUNCTION.H/W] item of [MASTER] and push the EDIT button to switch to the data input mode.

Select the function by turning the EDIT dial and push the EDIT button.

2. When you want to link this mixing with other mixes, move the cursor to the [LINK] item and push the EDIT button to switch to the data input mode.

Set the link mode to [+] or [-] by turning the EDIT dial and push the EDIT button.

*Check the direction by actual operation.

*Master channel control can be set to simple operating amount of sticks and VR which do not include ATV, AFR, D/R, and mixing setting. In this case, the switch setup screen is displayed by pushing the EDIT button with "H/W" selected by function selection. Select master channel side control. (To terminate the "H/W" selection, select the [--] display and push the EDIT button.

●Slave channel setting

1. Move the cursor to the [FUNCTION.H/W] item of [SLAVE] and push the EDIT button to switch

to the data input mode.

Select the function by turning the EDIT dial and push the EDIT button.

2. When you want to link this mix with other mixes, move the cursor to the [LINK] item and push the EDIT button to switch to the data input mode.

Set the link mode to [+] or [-] by turning the EDIT dial and push the EDIT button.

*Check the direction by actual operation.

●Trim mode ON/OFF setting

1. When changing the trim mode, move the cursor to the [TRIM] item and push the EDIT button to switch to the data input mode.

Select ON/OFF by turning the EDIT dial and set the selection by pushing the EDIT button.

*When mixing includes master side trim, select [ON] and when mixing does not include master trim, select [OFF].

*Effective when a function is set at the master channel.

●Slave channel AFR mode setting (STK-STK)

1. Move the cursor to the [STK-STK] item, select the mode by turning the EDIT dial, and change the mode by pushing the EDIT button.

*When link is set at the slave side, and you want to add AFR (D/R) to the mixing rate, select [ON].

*This is effective when the linkage is the same, but the travels are substantially different.

●Mixing curve setting

(For a description of the curve setting method, see the description at the back of this manual.)

●Fine tuning trim setting

Operation control [CTRL], operation mode [MODE], and rate [RATE] adjustment is possible by [FINE TUNING] item.

(For a description of the fine tuning trim setting method, see the description at the back of this manual.)

●Servo speed setting

Adjustment is possible with the [SPEED] item.

(For a description of the servo speed setting method, see the description at the back of this manual.)

●Mixing ON/OFF delay setting

Delay time at mix ON [START] and delay time at mix OFF [STOP] adjustment is possible by [DELAY] item.

*This function is inactive when a mixing switch is not set.

1. Move the [START] or [STOP] item and push the EDIT button to switch to the data input mode.

2. Adjust the delay time by turning the EDIT dial.
Initial value: 0.0 sec

Adjustment range: 0~4 sec

(When the EDIT button is pushed for 1 second, the delay time is reset to the initial value.)

Push the EDIT button to end adjustment and return to the cursor move mode.

MODEL MENU (AIRPLANE/GLIDER FUNCTIONS)

The dedicated mixes, etc. usable when airplane or glider model type is selected are displayed in this Model Menu functions section. First use the Model Type function of the Linkage Menu to preset the model type, wing type, and tail type matched to the fuselage used. Other settings reset the data used in mixing function, etc.

These dedicated mixes can be set for each flight condition, as required. When you want to use the system by switching the settings for each

condition by switch or stick position, use the Condition Select function to add flight conditions. (Up to 8 conditions can be used)

Note: The T12FG is designed so that the airplane and glider model types can handle aircraft of the same wing type.

The functions common to airplanes and gliders, except some dedicated functions, are summarized without regard to the model type.

The setting items are different, depending on the number of servos, etc. according to the wing type used. The setup screens in the instruction manual are typical examples.

- Select the [MODEL] at the home screen and call the model menu shown below by pushing the EDIT button.
- Use the EDIT dial to select the function you want to set and call the setup screen by pushing the EDIT button..

(Model Menu screen example)

*The Model Menu screen depends on the model type. This screen is for model type 4AIL+4FLP.

• Select the [MODEL MENU] and return to the home screen by pushing the EDIT button.

MODEL MENU	CONDIT1	(7.50) 1/3
SERVO MONITOR	PROG. MIXES	
COND. SELECT	AIL DIFF.	
AFR	FLAP SETTING	
DUAL RATE	AIL+CAMB.FLP	

S1 button
EDIT dial
EDIT button

- Push the **S1** button to call next page.
- Push the **S1** button for 1 second to return to the home screen.
- Turn the **EDIT** dial to move on the screen.

MODEL MENU	CONDIT1	(7.50) 2/3
AIL+BRAKEFLP	ELE+CAMBER	
AIL+RUD	CAMB.FLP+ELE	
AIRBRAKE+ELE	RUD+AIL	
CAMBER MIX	RUD+ELE	

MODEL MENU	CONDIT1	(7.50) 3/3
SNAP ROLL	MOTOR	
AIRBRAKE		
GYRO		
AILEVATOR		

Model Menu functions list

AIL DIFFERENTIAL

This function adjusts the left and right ailerons. Roll axis correction and fine tuning with a VR are also possible. This is convenient when making settings during flight.

[Airplane/glider, 2 ailerons or more]

FLAP SETTING

The flaps can be adjusted independently. For a 4 flaps model, the camber flaps can be mixed with the brake flaps. [Airplane/glider, 2 flaps or more]

AIL to CAMBERFLP

This mix operates the camber flaps in the aileron mode. It improves the operation

characteristic of the roll axis. [Airplane/glider, 2 ailerons + 2 flaps or more]

AIL to BRAKEFLP

This mix operates the brake flaps in the aileron mode. It improves the operation characteristic of the roll axis. [Airplane/glider, 4 flaps or more]

AIL to RUD

This mix is used when you want to operate the rudder at aileron operation. Banking at a shallow bank angle is possible. [Airplane/glider, general]

AIRBRAKE to ELE

This mix is used to correct operation of the airbrakes (spoilers) when landing. [Airplane/glider, general]

RUD to AIL

This mix is used to correct roll maneuvers, knife edge, etc. of stunt planes. [Airplane/glider, general]

CAMBER Mix

This mix adjusts the camber and corrects the elevators. [Airplane/glider, 2 ailerons or more]

ELE to CAMBER

This mix is used when you want to the mix camber flaps with elevator operation. Lifting force can be increased at elevators up. [Airplane/glider, 2 ailerons or more]

CAMBERFLP to ELE

This mix is used to correct for attitude changes when the camber flaps are being used. [Airplane/glider, 2 ailerons + 1 flap or more]

BUTTERFLY (Crow)

This function is used when powerful brake operation is necessary. [Glider, 2 ailerons or more]

TRIM MIX 1/2

The ailerons, elevators, and flaps trim offset rate can be called by switch or condition selection. [Glider, 2 ailerons or more]

AIRBRAKE

This function is used when airbrakes are necessary when landing or when diving, etc. during flight. (Airplane, general)

GYRO

This is a dedicated mix when a GYA Series gyro is used. [Airplane/glider, general]

V-TAIL

This function adjusts the elevators and rudder of V-tail models. [Airplane/glider, V-tail specifications]

AILEVATOR

This function adjusts the elevators and ailerons of models with elevator specifications. [Airplane/glider, elevator specifications]

WINGLET

This function adjusts the left and right rudders of winglet models. [Airplane/glider, winglet specifications]

MOTOR

The operation speed when the motor of F5B and other EP gliders is started by switch can be set. [EP glider, general]

RUD to ELE

This function is used to correct roll maneuvers, knife edge, etc. of stunt planes. [Airplane, general]

SNAP ROLL

This function selects the snap roll switch and adjusts the steering angle of each rudder. Servo speed can also be adjusted. [Airplane general]

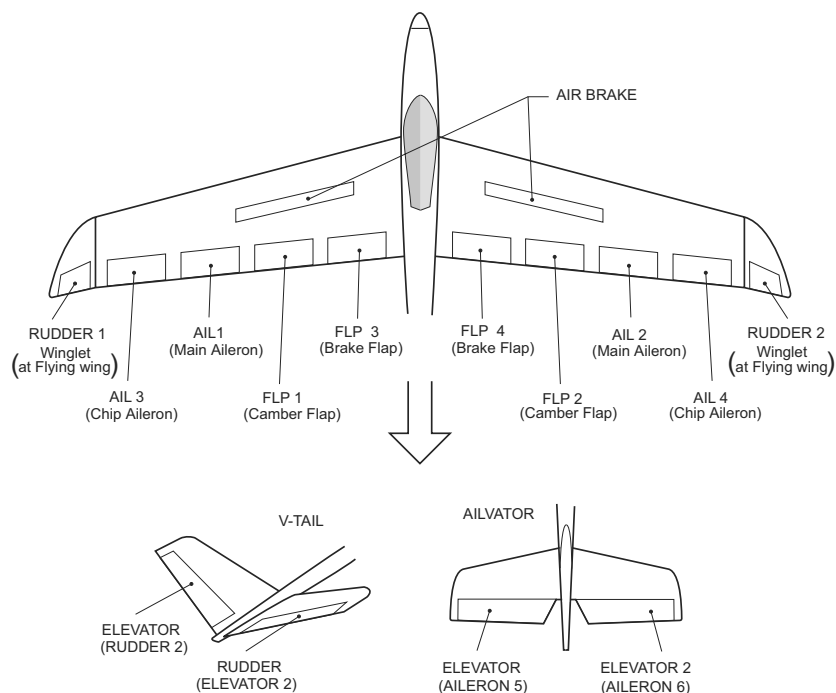

AIL DIFF.

[Airplane/glider, 2 ailerons or more]

The left and right aileron differential can be adjusted independently. The differential rate can also be adjusted according to the flying state by setting a fine tuning VR.

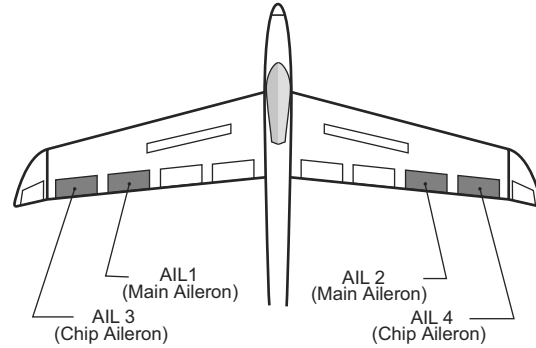

- Select [AIL DIFF.] at the model menu and call the setup screen shown below by pushing the EDIT button.
- Select the function name and return to the preceding screen by pushing the EDIT button.
- Aileron left/right adjustment
- Fine tuning VR setting
- Overall adjustment by Rate A and Rate B.

(Currently selected condition name)

• Group/single mode switching
(For more information, refer to the description at the back of this manual.)

• Push the **S1** button for 1 second to return to the home screen.

• Turn the **EDIT** dial to move on the screen.

• Calls the AFR screen directly when adjusting aileron operation AFR.

*The graph is operated by setting a VR, etc.

AIL DIFF. CONDIT1 (7.50) 1/1

	LEFT	RIGHT	GROUP	GROUP
AILERON	100%	100%		
AILERON2	100%	100%		
AILERON3	100%	100%		
AILERON4	100%	100%		

FINE TUNING: -- CURVE

AIL-AFR

AIL DIFF. CONDIT1 (7.50) 1/1

MODE	OFFSET
EXP 1	+0.0
RATE A	+100.0
RATE B	+100.0
EXP A	+0.0
EXP B	+0.0

POS +0.0 RATE +0.0

Setting method

- Move the cursor to the aileron (AIL) 1~4 left (or right) setting item and push the EDIT button to switch to the data input mode.

Adjust the aileron angles when the stick is moved to the left (or right) end.

Push the EDIT button to end adjustment and return to the cursor move mode.

*The aileron AFR screen can be directly called from the AIL Differential setup screen. ([AIL-AFR])

- When setting the fine tuning VR, move the cursor to the "--" item and push the EDIT button to call the selection screen, and then select the fine tuning VR.

Push the EDIT button to end adjustment and return to the cursor move mode.

- The fine tuning rate can be set by curve.

<Wing type: 4 ailerons screen>

*The display screen is an example. The actual screen depends on the Model Type.

FLAP SETTING

[Corresponding model type]: Airplane/glider, 2 flaps or more

The up/down travel of each flap (camber flaps: FLP1/2, brake flaps: FLP3/4) can be adjusted independently at each servo according to the wing type.

- The operation reference point of each flap can be offset

The camber flaps of a 4-flap model can be mixed with the brake flaps. (Brake FLP to camber FLP)

- An ON/OFF switch can be set.
- Select [FLAP SETTING] at the model menu and call the setup screen shown below by pushing the EDIT button.

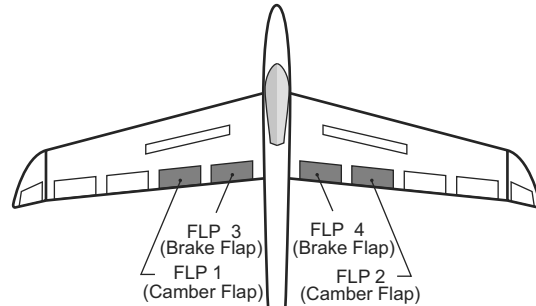

<Wing type: 4 flaps screen>

*The display screen is an example. The actual screen depends on the model type.

- Push the **S1** button to call next page.
- Push the **S1** button for 1 second to return to the home screen.
- Turn the **EDIT** dial to move on the screen.

(CAMBER FLP setting screen)

FLAP SETTING CONDIT1 7.5V 1/3		S1 button
CAMBER FLAP INH		EDIT dial
FLAP	FLP1	FLP2
UP	+100%	+100%
DOWN	+100%	+100%
OFFSET	+0%	+0%
GROUP	GROUP	

• Select the function name and return to the preceding screen by pushing the **EDIT** button.

(BRAKE FLP setting screen)

FLAP SETTING CONDIT1 7.5V 2/3		S1 button
BRAKE FLAP INH		EDIT dial
FLAP	FLP3	FLP4
UP	+100%	+100%
DOWN	+100%	+100%
OFFSET	+0%	+0%
GROUP	GROUP	

• Up side/Down side adjustment

• Operation reference point offset

(B.FLP to C.FLP setting screen)

FLAP SETTING CONDIT1 7.5V 3/3		S1 button
BRAKE FLAP → CAMBER FLAP		EDIT dial
UP	+100%	ACT/INH INH
DOWN	+100%	GROUP GROUP
OFFSET	+0%	SWITCH --

• Group/single mode switching
(For more information, refer to the description at the back of this manual.)

Setting method

- Move the cursor to the flap (FLP) 1~4 Up or Down item according to the wing type and push the EDIT button to switch to the data input mode.
Adjust the travel independently.
- To offset the operation reference point of each flap, move the cursor to the corresponding Offset item. Use the EDIT dial to offset the reference point.
Push the EDIT button to end adjustment and return to the cursor move mode.

- When using Brake FLP to Camber FLP mixing, move the cursor to the [ACT/INH] item and turn the EDIT dial to the left and push the EDIT button. (ON is displayed.)

When setting a switch, move the cursor to the [--] item of the switch and push the EDIT button to call the selection screen, and then select the switch and set its ON direction. (Always ON at "--" setting)

(For a description of the switch selection method, see the description at the back of this manual.)

AIL to CAMB.FLP

[Corresponding model type]: Airplane/glider, 2 ailerons + 2 flaps or more

This mix operates the camber flaps (FLP1/2) in the aileron mode. When the aileron stick is manipulated, the ailerons and camber flaps perform aileron operation simultaneously and the operation characteristic of the roll axis is improved.

- The aileron left/right mixing rate of each flap servo can be fine-tuned.
- A mixing curve can be set.
- An ON/OFF switch can be set.
- Linking is possible: Link this mix to other mixes.

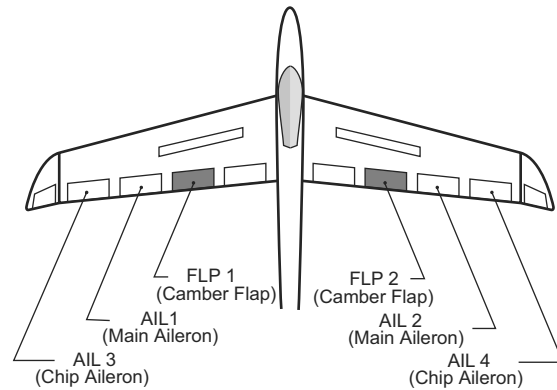

*The display screen is an example. The actual screen depends on the model type.

- Select [AIL to CAMB.FLP] at the model menu and call the setup screen shown below by pushing the EDIT button.

- Select the function name and return to the preceding screen by pushing the EDIT button.

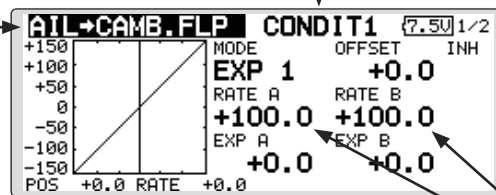

(Currently selected condition name)



- Push the **S1** button to call next page.
- Push the **S1** button for 1 second to return to the home screen.
- Turn the **EDIT** dial to move on the screen.

- Mixing curve setting

*For a description of the curve setting method, see the description at the back of this manual.

- Left/right overall adjustment at Rate A and Rate B

- Group/single mode switching

(For more information, refer to the description at the back of this manual.)

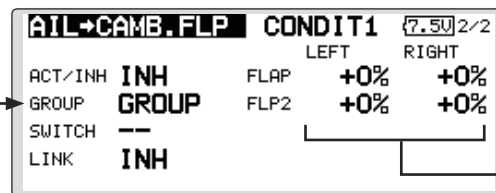

- Adjustment of each flap servo

Setting method

- Move the cursor to the ACT/INH item and push the EDIT button to switch to the data input mode.
Turn the EDIT dial to the left and push the EDIT button. (ON is displayed.)
- When setting a switch, move the cursor to the [--] item of the switch and push the EDIT button to call the selection screen, and then select the switch and set its ON direction. (Always ON at "--" setting)
(For a description of the switch selection method, see the description at the back of this manual.)
- Move the cursor to the left or right item of each flap servo and push the EDIT button to

switch to the data input mode.

Adjust the mixing rate with the EDIT dial.

Push the EDIT button to end adjustment and return to the cursor move mode.

*When the mixing direction is reversed by the linkage, adjustments can be made by changing the mixing rate polarity (+ or -).

- A mixing curve can be set.
(For a description of the mixing curve setting method, see the description at the back of this manual.)
- To set linking, move the cursor to the [LINK] item and push the EDIT button to switch to the data input mode.
Set it to ON and push the EDIT button.

AIL to BRAKEFLP

[Corresponding model type]: Airplane/glider, 4 flaps or more

This mix operates the brake flaps (FLP3/4) in the aileron mode. When the aileron stick is manipulated, the aileron and brake flaps perform the aileron operation simultaneously and the operation characteristic of the roll axis is improved.

- The aileron left and right mixing rates can be adjusted for each flap servo.
- A mixing curve can be set.
- Mixing during flight can be turned ON/OFF by setting a switch. (Always ON at [-] setting)
- Linking can be set: Link this mix to other mixes.

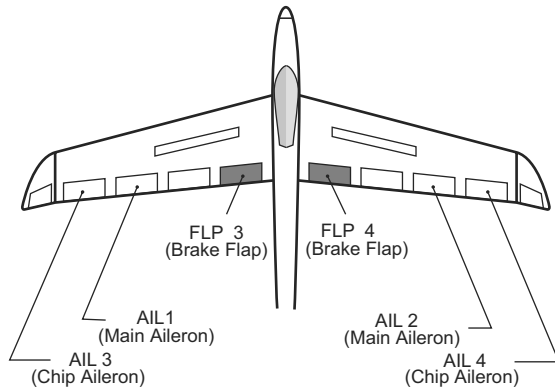

*The display screen is an example. The actual screen depends on the model type.

- Select [AIL to BRAKEFLP] at the model menu and call the setup screen shown below by pushing the EDIT button.

- Select the function name and return to the preceding screen by pushing the EDIT button.

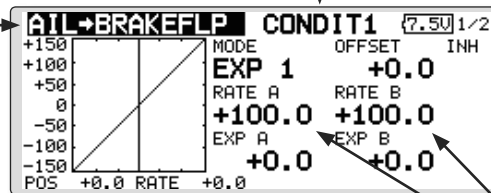

(Currently selected condition name)

- Push the **S1** button to call next page.

- Push the **S1** button for 1 second to return to the home screen.

- Turn the **EDIT** dial to move on the screen.



- Mixing curve setting

*For a description of the curve setting method, see the description at the back of this manual.

- Group/single mode switching

(For more information, refer to the description at the back of this manual.)

- Left/right overall adjustment at Rate A and Rate B

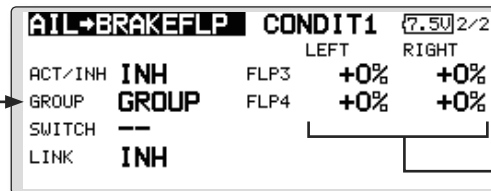

- Adjustment of each flap servo

Setting method

- Move the cursor to the ACT/INH item and push the EDIT button to switch to the data input mode.
Turn the EDIT dial to the left and push the EDIT button. (ON is displayed.)
- When setting a switch, move the cursor to the [-] item of the switch and push the EDIT button to call the selection screen, and then select the switch and set its ON direction. (Always ON at "-" setting)
(For a description of the switch selection method, see the description at the back of this manual.)
- Move the cursor to the left or right button of each flap servo and push the EDIT button to switch to the data input mode.

Adjust the mixing rate with the EDIT dial.

Push the EDIT button to end adjustment and return to the cursor move mode.

*When the mixing direction is reversed by the linkage, adjustments can be made by reversing the mixing rate polarity (+ or -).

- A mixing curve can be set.
(For a description of the curve setting method, see the description at the back of this manual.)
- To set linking, move the cursor to the Link item and push the EDIT button to switch to the data input mode.
Set it to ON and push the EDIT button.

AIL to RUD

[Corresponding model type]: Airplane/glider, general

Use this mix when you want to mix the rudders with aileron operation.

- A mixing curve can be set.
- Mixing during flight can be turned ON/OFF by setting a switch. (Always ON at [-] setting)
- The mixing rate can be fine-tuned by setting a VR.

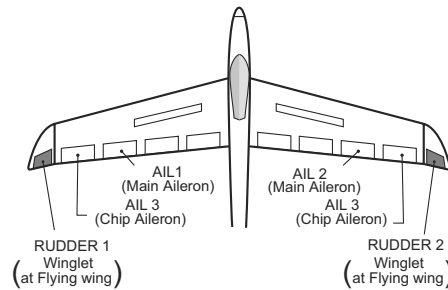

- Select [AIL to RUD] at the model menu and call the setup screen shown below by pushing the EDIT button.

- Select the function name and return to the preceding screen by pushing the EDIT button.

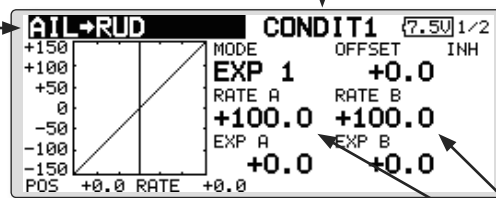

- Push the **S1** button to call next page.
- Push the **S1** button for 1 second to return to the home screen.
- Turn the **EDIT** dial to move on the screen.



- Mixing curve setting
*For a description of the curve setting method, see the description at the back of this manual.

- Group/single mode switching
(For more information, refer to the description at the back of this manual.)

- Left/right overall adjustment at Rate A and Rate B

*The display screen is an example. The actual screen depends on the model type.

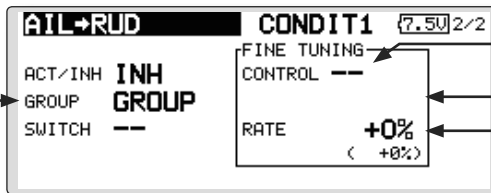

- Fine tuning VR setting
- Operation mode
- Adjustment rate

Setting method

- Move the cursor to the ACT/INH item and push the EDIT button to switch to the data input mode.
Turn the EDIT dial to the left and push the EDIT button. (ON is displayed.)
- When setting a switch, move the cursor to the [-] item of the switch and push the EDIT button to call the selection screen, and then select the switch and set its ON direction. (Always ON at "-" setting)
(For a description of the switch selection method, see the description at the back of this manual.)
- When setting a VR, move the cursor to the Fine Tuning "-" item and push the EDIT button to call the selection screen, and then select the VR. The adjustment rate can be set. The VR operation mode can also be selected.
- A mixing curve can be set.

(For a description of the curve setting method, see the description at the back of this manual.)

[Fine tuning VR operation mode]

- [LIN.]** Mixing rate 0% at center of VR. When the VR is turned clockwise and counterclockwise, the mixing rate increases and decreases, respectively.
- [ATL+]** Mixing rate 0% at left end of VR. When the VR is turned, the mixing rate increases.
- [ATL-]** Mixing rate 0% at right end of VR. When the VR is turned, the mixing rate increases.
- [SYM.]** When the VR is turned to the left or right of the neutral position, the mixing rate increases.

AIRBRAKE to ELE

[Corresponding model type]: Airplane/glider, general

This mix is used when you want to mix the elevators with airbrake (spoiler) operation. It raises the elevators to correct for dropping of the nose during airbrake operation.

*This function does not operate when airbrake is not assigned at the Function menu in the Linkage Menu.

- The Rate 1 side/Rate 2 side mixing rate with the elevator servos can be adjusted.
- A mixing curve can be set.
- Mixing during flight can be turned ON/OFF by setting a switch. (Always ON at [-] setting)
- The mixing rate can be fine-tuned by setting a VR.

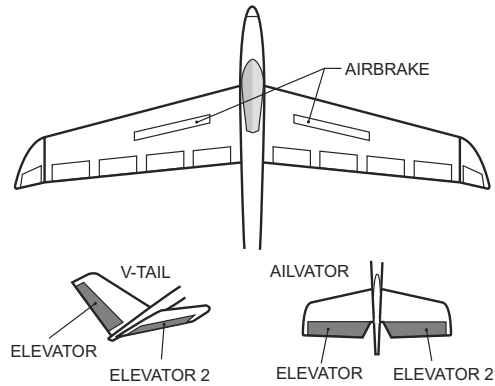

*The display screen is an example. The actual screen depends on the model type.

- Select [AIRBRAKE to ELE] at the model menu and call the setup screen shown below by pushing the EDIT button.

- Select the function name and return to the preceding screen by pushing the EDIT button.

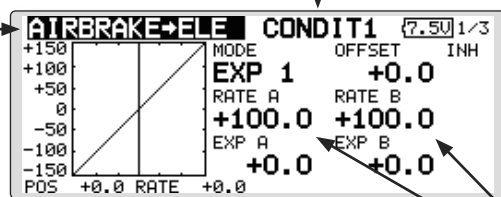

- Push the **S1** button to call next page.
- Push the **S1** button for 1 second to return to the home screen.
- Turn the **EDIT** dial to move on the screen.

- Group/single mode switching
(For more information, refer to the description at the back of this manual.)

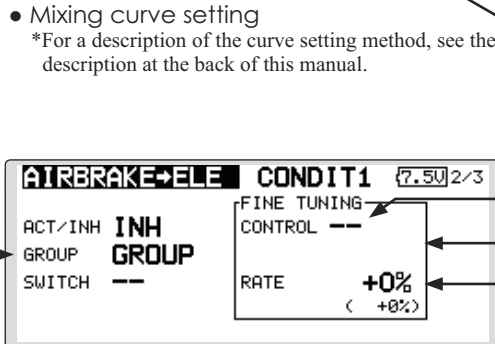

- Overall adjustment by Rate A and Rate B.

- Adjustment of each elevator servo

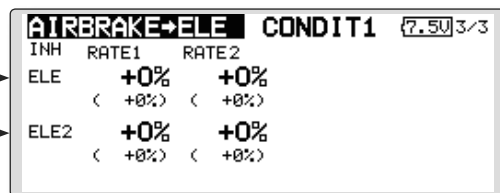

Setting method

- Move the cursor to the ACT/INH item and push the EDIT button to switch to the data input mode.

Turn the EDIT dial to the left and push the EDIT button. (ON is displayed.)

- When setting a switch, move the cursor to the [-] item of the switch and push the EDIT button to call the selection screen, and then select the switch and set its ON direction. (Always ON at "--" setting)

(For a description of the switch selection method, see the description at the back of this manual.)

- When setting a VR, move the cursor to the Fine tuning "--" item and push the EDIT button to call the selection screen, and then select the VR. The adjustment rate can be set. The VR operation mode can also be set.

(For a description of the fine tuning VR setting method, see the description at the back of this manual.)

- A mixing curve can be set.

(For a description of the curve setting method, see the description at the back of this manual.)

[Fine tuning VR operation mode]

[LIN.] Mixing rate 0% at center of VR. When the VR is turned clockwise and counterclockwise, the mixing rate increases and decreases, respectively.

[ATL+] Mixing rate 0% at left end of VR. When the VR is turned, the mixing rate increases.

[ATL-] Mixing rate 0% at right end of VR. When the VR is turned, the mixing rate increases.

[SYM.] When the VR is turned to the left or right of the neutral position, the mixing rate increases.

This function is used when you want to mix the ailerons with rudder operation. It is used when rudder is applied during roll maneuvers, knife edge, etc. of stunt planes. It can be used to bank scale models, large models, etc. like a full size plane.

- A mixing curve can be set.
- Mixing during flight can be turned ON/OFF by setting a switch. (Always ON at [--] setting)
- Linking can be set: Link this mix to other mixes.
- The mixing rate can be fine-tune by setting a VR.

- Select [RUD to AIL] at the model menu and call the setup screen shown below by pushing the EDIT button.

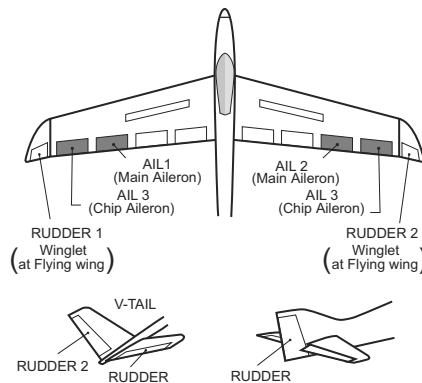

- Select the function name and return to the preceding screen by pushing the EDIT button.

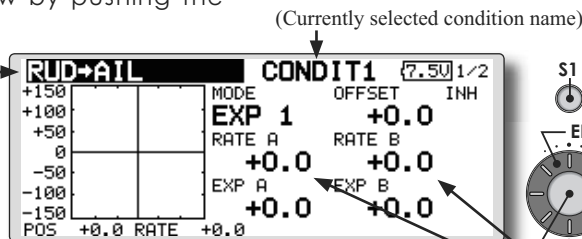

- Push the **S1** button to call next page.
- Push the **S1** button for 1 second to return to the home screen.
- Turn the **EDIT** dial to move on the screen.



- Mixing curve setting
*For a description of the curve setting method, see the description at the back of this manual.

- Group/single mode switching

(For more information, refer to the description at the back of this manual.)

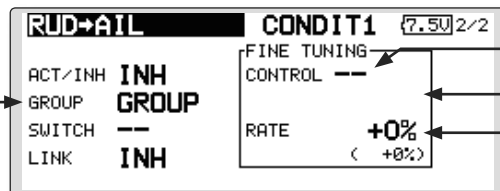

- Left/right overall adjustment at Rate A and Rate B

- Fine tuning VR setting
- Operation mode
- Adjustment rate

*The display screen is an example. The actual screen depends on the model type.

Setting method

- Move the cursor to the ACT/INH item and push the EDIT button to switch to the data input mode.

Turn the EDIT dial to the left and push the EDIT button. (ON is displayed.)

- When setting a switch, move the cursor to the [--] item of the switch and push the EDIT button to call the selection screen, and then select the switch and set its ON direction. (Always ON at "--" setting)

(For a description of the switch selection method, see the description at the back of this manual.)

- When setting a VR, move the cursor to the Fine tuning "--" item and push the EDIT button to call the selection screen and then select the VR. The adjustment rate can be set.

The VR operation mode can also be set.

(For a description of the fine tuning VR setting method, see the description at the back of this manual.)

- A mixing curve can be set.

(For a description of the curve setting method, see the description at the back of this manual.)

- When linking: move the cursor to the [LINK] item and push the EDIT button to switch to the data input mode. Turn the EDIT dial to the left and push the EDIT button. (ON is displayed.)

[Fine tuning VR operation mode]

[LIN.] Mixing rate 0% at center of VR. When the VR is turned clockwise and counterclockwise, the mixing rate increases and decreases, respectively.

[ATL+] Mixing rate 0% at left end of VR. When the VR is turned, the mixing rate increases.

[ATL-] Mixing rate 0% at right end of VR. When the VR is turned, the mixing rate increases.

[SYM.] When the VR is turned to the left or right of the neutral position, the mixing rate increases.

CAMBER MIX

[Corresponding model type]: Airplane/glider, 2 ailerons or more

This function adjusts the AFR (D/R) rate of camber operation which operates the wing camber (aileron, camber flaps, brake flaps) in the negative and positive directions. The aileron, flap, and elevator rates can also be adjusted independently by curve, and attitude changes caused by camber operation can be corrected.

*Initial setting assigns camber operation to side lever LS.

- The up/down side rates of the aileron, flap, and elevator servos can be adjusted by curve. When the mixing direction is reversed by the linkage, adjustments can be made by changing the mixing rate polarity (+ or -).

- Mixing during flight can be turned ON/OFF by setting a switch. (Always ON at [-] setting)
- A delay can be set for each condition. A cut switch which can turn OFF the delay function can be set.
- The speed of the aileron, flap, and elevator servos can be set. (IN side/OUT side)

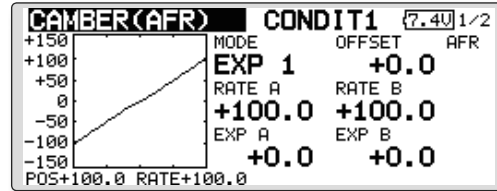

- Select [CAMBER MIX] at the model menu and call the setup screen shown below by pushing the EDIT button.

(Currently selected condition name)

- Select the function name and return to the preceding screen by pushing the EDIT button.

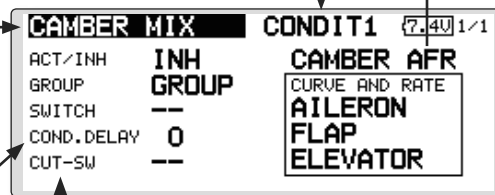

- Condition delay setting

- Condition delay cut switch

- Camber AFR (D/R) setup screen call (For a description of the setting method, refer to the AFR function.)

- Push the **S1** button to call next page.

- Push the **S1** button for 1 second to return to the home screen.

- Turn the **EDIT** dial to move on the screen.

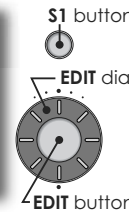

- Overall adjustment by Rate A and Rate B

(Curve/rate setting screen)

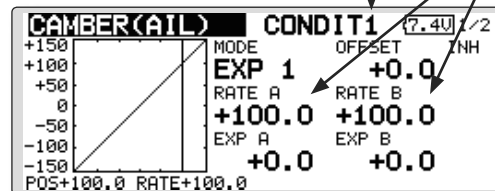

- Mixing curve setting

*For a description of the curve setting method, see the description at the back of this manual.

- Aileron rate adjustment

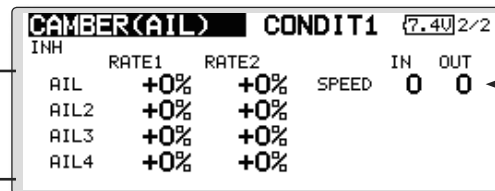

- Servo speed setting

(For a description of the setting method, see the description at the back of this manual.)

*The display screen is an example. The actual screen depends on the model type.

Setting method

- Move the cursor to the ACT/INH item and push the EDIT button to switch to the data input mode.

Turn the EDIT dial to the left and push the EDIT button. (ON is displayed.)

- When setting a switch, move the cursor to the [-] item of the switch and push the EDIT button to call the selection screen, and then select the switch and set its ON direction. (Always ON at "-" setting)

(For a description of the switch selection method, see the description at the back of this manual.)

- When setting a condition delay, move the cursor to the [COND.DELAY] item and push the EDIT button to switch to the data input mode.

Set the delay with the EDIT dial.

Push the EDIT button to end adjustment and return to the cursor move mode.

When setting a cut switch, move the cursor to [CUT-SW] item and push the EDIT button to call the selection screen, and then select the

switch and set its ON direction. (Always ON at [-] setting)

(For a description of the condition delay function, see the description at the back of this manual.)

- Camber AFR(D/R) screen call

Move the cursor to the Camber AFR item and push the EDIT button to call the setup screen. (For a description of the setup method, see the description at the back of this manual.)

(Curve/rate setup screen)

- The curve and rate are adjusted by calling the aileron, flap, and elevator curve/rate screens.

The rate and curve of each servo can be set by calling each screen. (For a description of the curve setting method, see the description at the back of this manual.)

The servo speed can also be adjusted.

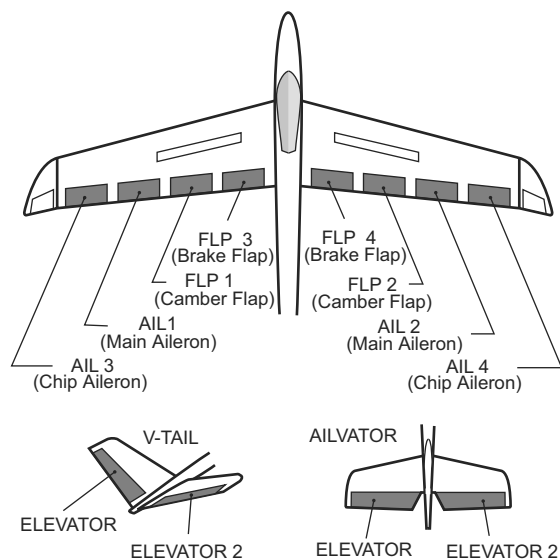

ELE to CAMBER

[Corresponding model type]: Airplane/glider, 2 ailerons or more

This function is used when you want to mix the camber flaps with elevator operation. When used, the flaps are lowered by up elevator, and lift can be increased.

Note: Tailless wing elevator can be operated

when this mix is activated.

- A mixing curve can be set.
- Mixing during flight can be turned ON/OFF by setting a switch. (Always ON at [-] setting)
- The mixing rate can be fine-tuned by setting a VR.

- Select [ELE to CAMBER] at the model menu and call the setup screen shown below by pushing the EDIT button.

(Currently selected condition name)

- Push the **S1** button to call next page.
- Push the **S1** button for 1 second to return to the home screen.
- Turn the **EDIT** dial to move on the screen.

- Select the function name and return to the preceding screen by pushing the **EDIT** button.
- Mixing curve setting
*For a description of the curve setting method, see the description at the back of this manual.

- Overall adjustment by Rate A and Rate B.

- Ailerons and flaps rate adjustment

1. Select the rate box and push the EDIT button to switch to the data input mode.
2. Adjust the rates by turning the EDIT dial.
3. Push the EDIT button to end adjustment and return to the cursor move mode.

- Group/single mode switching
(For more information, refer to the description at the back of this manual.)

- Fine tuning VR setting
- Operation mode
- Adjustment rate

*The display screen is an example. The actual screen depends on the model type.

Setting method

- Move the cursor to the ACT/INH item and push the EDIT button to switch to the data input mode.
Turn the EDIT dial to the left and push the EDIT button. (ON is displayed.)
- When setting a switch, move the cursor to the [-] item of the switch and push the EDIT button to call the selection screen, and then select the switch and set its ON direction. (Always ON at "-" setting)
(For a description of the switch selection method, see the description at the back of

this manual.)

- When setting a VR, move the cursor to the Fine tuning "-" item and push the EDIT button to call the selection screen, and then select the VR. The adjustment rate can be set.
The VR operation mode can also be selected.
- A mixing curve can also be set.
(For a description of the curve setting method, see the description at the back of this manual.)

CAMB.FLP to ELE

[Corresponding model type]: Airplane/glider,
2 ailerons + 1 flap or more

This mixing is used to correct changes (elevator direction) generated when the camber flaps (speed flaps) are used.

- The elevator servos up side/down side rate can be adjusted. When the mixing direction is reversed by the linkage, adjustments can be made by changing the mixing rate polarity (+ or -).
- A mixing curve can be set.
- Mixing during flight can be turned ON/OFF by setting a switch. (Always ON at [-] setting)
- The mixing rate can be fine-tuned by setting a VR.

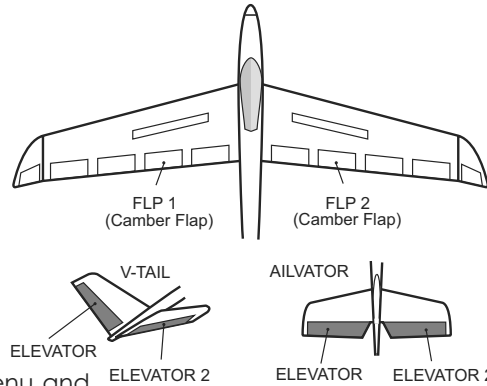

- Select [CAMB.FLP to ELE] at the model menu and call the setup screen shown below by pushing the EDIT button.

- Select the function name and return to the preceding screen by pushing the EDIT button.

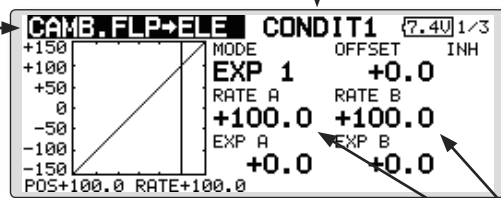

- Mixing curve setting
*For a description of the curve setting method, see the description at the back of this manual.

- Group/single mode switching
(For more information, refer to the description at the back of this manual.)

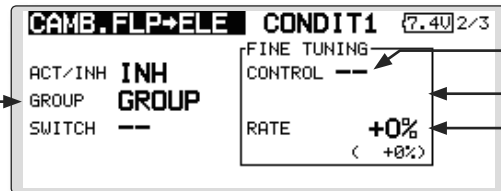

- Push the **S1** button to call next page.
- Push the **S1** button for 1 second to return to the home screen.
- Turn the **EDIT** dial to move on the screen.
- Overall adjustment by Rate A and Rate B.

- Elevator rate adjustment

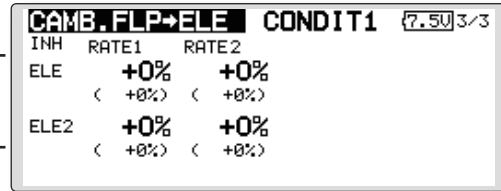

*The display screen is an example. The actual screen depends on the model type.

Setting method

- Move the cursor to the ACT/INH item and push the EDIT button to switch to the data input mode.
Turn the EDIT dial to the left and push the EDIT button. (ON is displayed.)
- When setting a switch, move the cursor to the [-] item of the switch and push the EDIT button to call the selection screen, and then select the switch and set its ON direction. (Always ON at "-" setting)
(For a description of the switch selection method, see the description at the back of this manual.)
- Move the cursor to the elevator servos left and right item and push the EDIT button to

switch to the data input mode. Adjust the mixing rate with the EDIT dial.

Push the EDIT button to end adjustment and return to the cursor move mode.

*When the mixing direction is reversed by the linkage, adjustments can be made by changing the mixing rate polarity (+ or -).

- When setting a VR, move the cursor to the Fine tuning "-" item and push the EDIT button to call the selection screen, and then select the VR. The VR operation mode can be selected.
- A mixing curve can be set.
(For a description of the curve setting method, see the description at the back of this manual.)

This function allows powerful brake operation by simultaneously raising the left and right ailerons and lowering the flaps (camber flap, brake flap).

This setting will allow the ailerons to be raised while the flaps are simultaneously lowered. Butterfly (Crow) produces an extremely efficient landing configuration by accomplishing the following:

1. Slow the aircraft's velocity.
2. Provide washout at the wing tips to reduce the tendency to tip stall.
3. Create more lift toward the center of the wing allowing it to fly at a slower speed

- Mixing during flight can be turned ON/OFF by setting a switch. (Always ON at [-] setting)
- The butterfly operation reference point can be offset. When the EDIT button is pushed with the Offset item selected when operated to the position to be changed, the reference point is offset. If the reference point is offset too much, unexpected operation may be performed.
- The ailerons and flaps operation speed can be adjusted. (IN side/OUT side)
- A delay can be set for each condition. A cut switch which can turn OFF the delay function can also be set.
- The differential rate can be adjusted.

*When servo binding occurs when setting the ailerons and flaps in butterfly mixing, use the AFR function to adjust the rudder angle.

- Select [BUTTERFLY] at the model menu and call the setup screen shown below by pushing the EDIT button.

(Currently selected condition name)

• Select the function name and return to the preceding screen by pushing the EDIT button.

• Select the Mixing Rate AIL and FLP box and push the EDIT button to switch to the data input mode. Adjust the mixing rates. Push the EDIT button to end adjustment and return to the cursor move mode.

• To elevator correction setup screen

• Calls the Butterfly AFR (D/R) setup screen (For a description of the setting method, see the description at the back of this manual.)

*The display screen is an example. The actual screen depends on the model type.

• Push the **S1** button to call next page.

• Push the **S1** button for 1 second to return to the home screen.

• Turn the **EDIT** dial to move on the screen.

- When using this function, move the cursor to the [ACT/INH] item and push the EDIT button to switch to the data input mode. Turn the EDIT dial to the left and push the EDIT button. (ON is displayed.)
- Group/single mode switching (For more information, see the description at the back of this manual.)
- When setting a switch, select the SWITCH [-] box and push the EDIT button to switch to the data input mode. Press the EDIT button to call the selection screen, and then select the switch and set its ON direction.

- Aileron and flap servos speed setting (For a description of the setting method, see the description at the back of this manual.)
- When offsetting the butterfly operation reference point, operate to the point you want to change and then press the EDIT button for 1 second.

- Differential rate adjustment
- Condition delay setting and cut switch setting (For a description of the setting method, see the description at the back of this manual.)

(Elevator correction rate setup screen)

• Overall adjustment by Rate A and Rate B

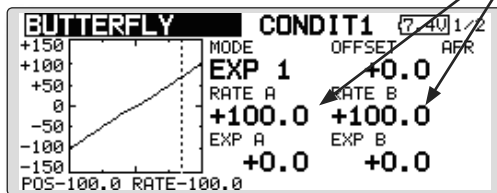

• Mixing curve setting

*For a description of the curve setting method, see the description at the back of this manual.

• Elevator rate adjustment

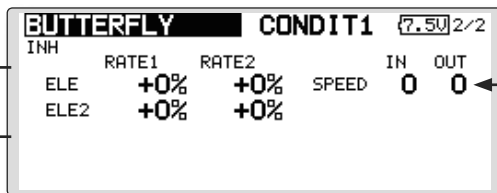

• Servo speed setting

(For a description of the setting method, see the description at the back of this manual.)

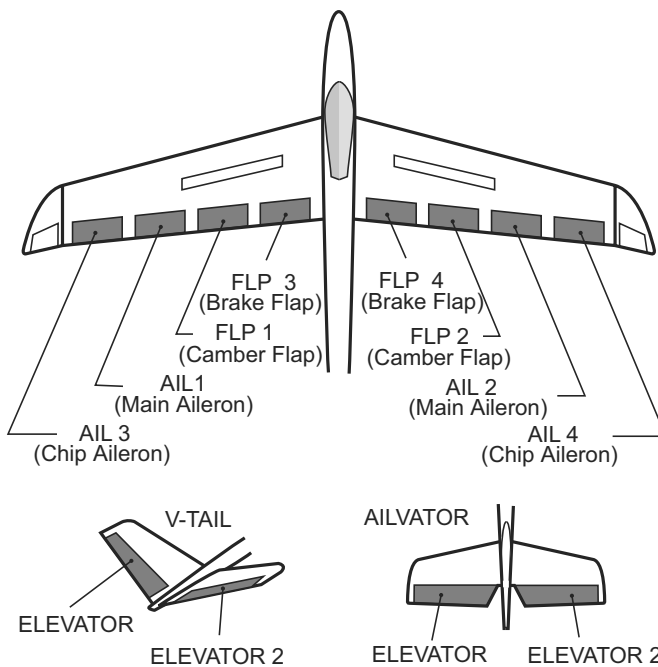

These functions call the ailerons, elevators, and flaps (camber flaps, brake flaps) trim offset rates preset according to the flight state.

The amount of ailerons, elevator, and flaps (camber flap, brake flap) trim offset can be set to a switch.

As an example **Trim Mix 1** can be set up for launching, with speed flaps and ailerons dropped, and a slight amount of up elevator. **Trim mix 2** can be used for high speed flying, with both ailerons and speed flaps reflexed slightly, and a bit of down elevator.

The trim functions can be activated during flight by setting a switch. To prevent sudden trim changes when switching flight conditions, a delay can be set to provide a smooth transition between the two. Trim Mix 2 will have priority over Trim Mix 1.

Example

- Move to the ACT/INH item and push the EDIT button to switch to the data input mode. Set the trim mix function to [ON].
*When separating the settings for each condition, move to the [GROUP] item and set it to [Single].
- Select the ON/OFF switch.
- Select the [Manual] or [Auto] mode.
In the [Auto] mode, also select an auto SW. This switch can be linked to a stick, etc.

<Speed>
In: The operation speed at switch ON can be set.
Out: The return speed at switch OFF can be set.

<Fine Tuning>
The offset rate can be varied in the Fine Tuning numeric range set at screen [5/5] by VR, etc. selection.

<Condition Delay>
When flight conditions are set, the operation speed can be set for each condition. Condition delay operation can be interrupted and each rudder quickly returned to its original position by selecting a cut switch.

- Select [TRIM MIX1 or 2] at the model menu and call the setup screen shown below by pushing the EDIT button.

*The display screen is an example. The actual screen depends on the model type.

• Select the function name and return to the preceding screen by pushing the EDIT button.

• Push the **S1** button to call next page.

• Push the **S1** button for 1 second to return to the home screen.

• Turn the **EDIT** dial to move on the screen.

(Currently selected condition name)

- When a fine tuning VR is set on the next page, the ailerons flaps and elevators trim rates can be adjusted.

Move the cursor to the corresponding setting item and push the EDIT button to switch to the data input mode. adjust the rate with the EDIT dial.

Push the EDIT button to end adjustment and return to the cursol move mode.

- When using this function, move the cursor to the [ACT/INH] item and push the EDIT button to switch to the data input mode. Turn the EDIT dial to the left and push the EDIT button. (ON is displayed.)
- Group/single mode switching
(For more information, see the description at the back of this manual.)

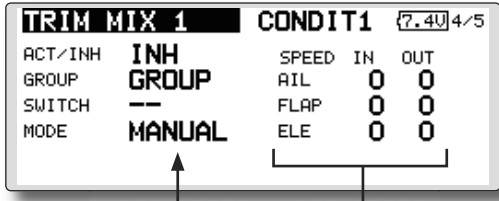

- Manual/Auto mode selection
Manual: Switches the function ON/OFF by switch
Auto: Trim mix function call can be linked to a stick, etc. A stick switch, etc. separate from the function ON/OFF switch is set.

- Ailerons, flaps, an elevators servo speed setting
(For a description of the setting method, see the description at the back of this manual.)

- When using a fine tuning VR, move the cursor to this item and push the EDIT button to call the selection screen. Select the VR and push the EDIT button.

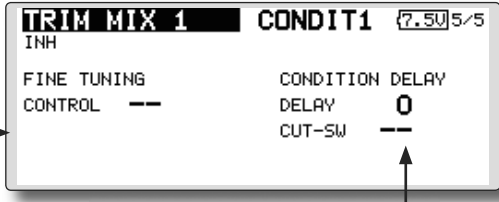

- Condition delay setting (for a description of the setting method, see the description at the back of this manual) and cut switch setting.

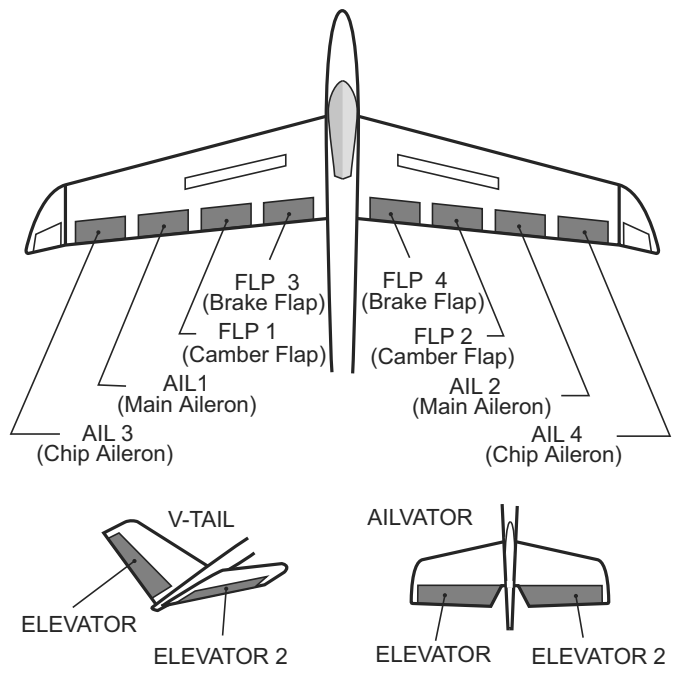

This function is used when an air brake is necessary when landing or diving, etc.

The preset elevators and flaps (camber flap, brake flap) offset amount can be activated by a switch.

The offset amount of the aileron, elevator, and flap servos can be adjusted as needed. Also the speed of the aileron, elevator, and flap servos can be adjusted. (IN side/OUT side) A delay can be set for each condition, and a Cut switch which will turn OFF the delay can be chosen. Trim amounts can be fine-tuned by setting a VR You can also set the Auto Mode, which will link Airbrake to a stick, switch, or dial. A separate stick switch or dial can also be set as the ON/OFF switch.

Setting example for F3A and other flaperon specifications

(When 2 ailerons model type selected)

Offset rate:

AIL: [-35~45%], AIL2: [-35~45%], ELE: [+5~7%]

Note: The input numerics are examples. Adjust the travel to match the aircraft.

Mode setting:

ACT: [ON]

Group: [Single]

Switch: [SW-C]

Mode: [Manual]

*The display screen is an example. The actual screen depends on the model type.

- Select [AIRBRAKE] at the model menu and call the setup screen shown below by pushing the EDIT button.

(Currently selected condition name)

- Select the function name and return to the preceding screen by pushing the EDIT button.

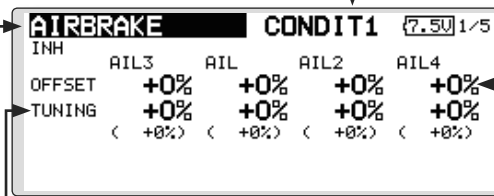

- Push the **S1** button to call next page.
- Push the **S1** button for 1 second to return to the home screen.
- Turn the **EDIT** dial to move on the screen.

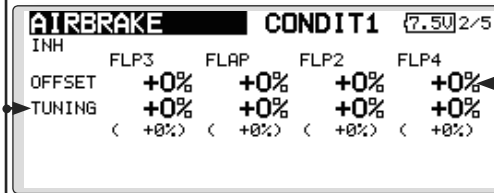

- The ailerons, flaps, and elevators offset rate can be adjusted.

Move the cursor to the corresponding setting item and push the EDIT button to switch to the data input mode. Adjust the rate with the EDIT dial.

Push the EDIT button to end adjustment and return to the cursor move mode.

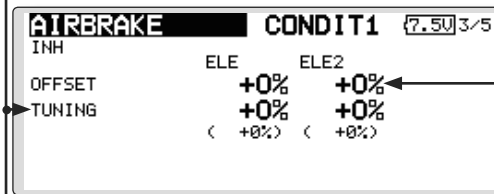

- When a fine tuning VR is set on the next page, the ailerons', flaps', and elevators' trim rates can be adjusted.

Move the cursor to the corresponding setting item and push the EDIT button to switch to the data input mode. Adjust the rate with the EDIT dial.

Push the EDIT button to end adjustment and return to the cursor move mode.

- When using this function, move the cursor to the [ACT/INH] item and turn the EDIT dial to the left and push the EDIT button. (ON is displayed.)
- Group/single mode switching
(For more information, see the description at the back of this manual.)

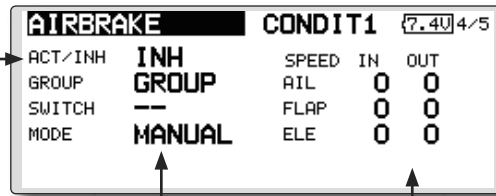

- Manual/Auto mode selection
Manual: Switches the function ON/OFF by switch
Auto: Trim mix function call can be linked to a stick, etc. A stick switch, etc. separate from the function ON/OFF switch is set.
- Ailerons, flaps, an elevators servo speed setting
(For a description of the setting method, see the description at the back of this manual.)

- When using a fine tuning VR, move the cursor to this setting item and press the EDIT button to call the selection screen.
Select the VR and push the EDIT button.

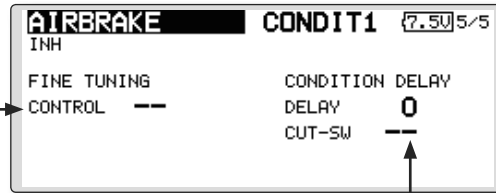

- Condition delay setting (for a description of the setting method, see the description at the back of this manual) and cut switch setting.

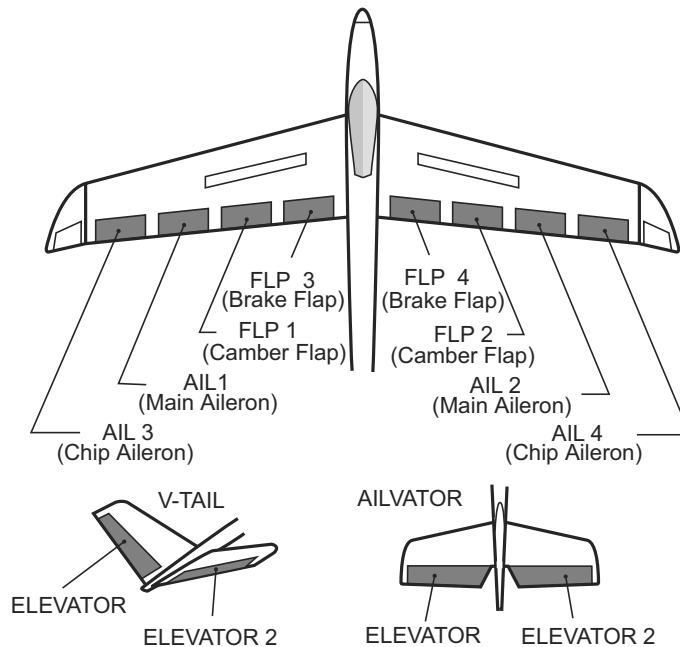

GYRO

[Corresponding model type]: Airplane/glider, general

This function is used when a GYA Series gyro is used to stabilize the aircraft's attitude. The sensitivity and operation mode (Normal mode/GY mode) can be switched with a switch.

- Three rates (Rate 1/Rate 2/Rate 3) can be switched.
- Up to 3 axes (Gyro/Gyro 2/Gyro 3) can be simultaneously controlled.

*Initial setting does not assign a sensitivity channel. Use the Function menu of the Linkage Menu to assign the sensitivity channel (Gyro/Gyro2/Gyro3) used to a vacant channel beforehand.

Set [Control] and [Trim] other than Function to [--].

• Select [GYRO] at the model menu and call the setup screen shown below by pushing the EDIT button.

(Currently selected condition name)

• Select the function name and return to the preceding screen by pushing the EDIT button.

• Push the **S1** button to call next page.

• Push the **S1** button for 1 second to return to the home screen.

• Turn the **EDIT** dial to move on the screen.

ACT/INH	INH	MODE	RATE
TYPE	GY	GYRO	AVCS 0%
SWITCH	--	GYRO2	AVCS 0%
GROUP	GRP	GYRO3	AVCS 0%

• Group/single mode switching
(For more information, see the description at the back of this manual.)

• The operation mode (AVCS/NOR) and sensitivity of the 3 axes Gyro/Gyro2/Gyro3 can be set.

- Three rates (Rate 1/Rate 2/Rate 3) can be used.
Move the cursor to the [RATE] item and push the EDIT button to switch to the data input mode. Adjust the rate by turning the EDIT dial.
- When using this function, move the cursor to the [ACT] item and push the EDIT button to switch to the data input mode. Turn the EDIT dial to the left and push the EDIT button.
- When a Futaba GYA gyro is used, when [GY] type is selected, the sensitivity set value is directly read in both the AVCS and NORM modes.
- When setting a switch, move the cursor to the SWITCH item and press the EDIT button to call the selection screen, and then select the switch and set its ON direction.
(For a description of the switch selection method, see the description at the end of this manual.)

(Example) Setting 3 axes using a GYA351 and GYA352 (2 axes gyro)

- Wing type: Aileron 2 servos mounted fuselage selected
- Set Gyro 1 (GYA351): CH7, Gyro 2 (GYA352): CH8, Gyro 3 (GYA352): CH9 at the Function menu of the Linkage Menu.
- Rate 1 [OFF][GY][SW-E][GRP][NORM][60%][NORM][60%][NORM][60%]
Rate 2 [INH][GY][--][GRP][AVCS][0%][AVCS][0%][AVCS][0%]
Rate 3 [OFF][GY][SE-E][GRP][AVCS][60%][AVCS][60%][AVCS][60%]
*When separating the conditions, set to [SNGL].
- *Set so that Rate 1 is turned on at the back position of switch E and Rate 3 is turned ON at the front position.
Since switch E is turned OFF at the center, Rate 2 remains [INH].

V-TAIL

[Corresponding model type]: Airplane/glider, V-tail

This function let's you adjust for left and right rudder angle changes at elevator and rudder operation of a V-tail airplane.

V-tail is when 2 servos are used together to control rudder movement as elevators. In addition to each rudder side moving up and down together, each side moves in opposite directions when moving as elevators. On a V-tail, this is also known as a Ruddervator, as they can serve the same purpose.

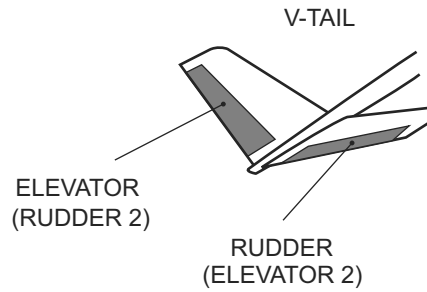

- Select [V-TAIL] at the model menu and call the setup screen shown below by pushing the EDIT button.
- Select the function name and return to the preceding screen by pushing the EDIT button.

Group/single mode switching
(For more information, see the description at the back of this manual.)

(Currently selected condition name)

V-TAIL		CONDIT1		7.40	1/1
GROUP	GROUP				
FUNCTION	ELEVATOR		RUDDER		
	DOWN	UP	LEFT	RIGHT	
ELE <RUD2>	+50%	+50%	+50%	+50%	
RUD <ELE2>	+50%	+50%	+50%	+50%	

(Elevator function) (Rudder function)

Up and down travel adjustment at CH1 and CH2 elevator operation Left and right travel adjustment at CH1 and CH2 rudder operation

S1 button • Push the S1 button for 1 second to return to the home screen.

EDIT dial • Turn the EDIT dial to move on the screen.

EDIT button

- Travel adjustment
 - Move the cursor to the item you want to adjust and push the EDIT button to switch to the data input mode.
 - Adjust the rate by turning the EDIT dial.
 - Push the EDIT button to end adjustment and return to the cursor move mode.
 - *If the mixing direction is reversed by the linkage, adjustments can be made by changing the mixing rate polarity (+ or -).
 - *If a large value of travel is specified, when the sticks are moved at the same time, the controls may bind or run out of travel. Decrease the travel until no binding occurs.

AILEVATOR

[Corresponding model type]: Airplane/glider, V-Tail
(Effective only when 2 servos used at the elevators)

This function improves the operating performance of the roll axis by operating the elevators as ailerons.

Ailevator is where each elevator in a standard (conventional) or v-tail moves independently, like ailerons on a wing. In addition to each elevator side moving up and down together, each side moves in opposite directions when moving as an Ailevator. On a V-tail, this is also known as a Ruddervator, as they can serve the same purpose. Typically, both Ailevator and ailerons are coupled together to maximize roll performance, especially on larger wingspan planes.

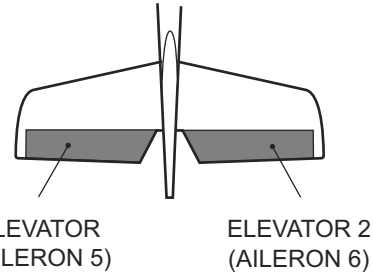

Note: Select Ailevator as the Model Type at the Model Type screen. This changes the output channel. Check the Function menu.

- Select [AILEVATOR] at the model menu and call the setup screen shown below by pushing the EDIT button.
- Select the function name and return to the preceding screen by pushing the EDIT button.
- Group/single mode switching (For more information, see the description at the back of this manual.)
- Push the **S1** button for 1 second to return to the home screen.
- Turn the **EDIT** dial to move on the screen.

AILEVATOR **CONDIT1** 7.40 1/1

GROUP	GROUP		AILERON	
FUNCTION	ELEVATOR DOWN	UP	LEFT	RIGHT
ELE <AIL5>	+100%	+100%	+0%	+0%
ELE2<AIL6>	+100%	+100%	+0%	+0%

(Elevator function) (Aileron function)

- The up and down rate of the left and right elevators when the elevator stick is manipulated can be individually adjusted.
- When the elevators are used as ailerons, aileron travel of the left and right elevators can be adjusted.

- **Travel adjustment**
Move the cursor to the item you want to adjust and push the EDIT button to switch to the data input mode.
Adjust the rate by turning the EDIT dial.
Push the EDIT button to end adjustment and return to the cursor move mode.
*If the mixing direction is reversed by the linkage, adjustments can be made by changing the mixing rate polarity (+ or -).
*If a large value of travel is specified, when the sticks are moved at the same time, the controls may bind or run out of travel. Decrease the travel until no binding occurs.

WINGLET

[Corresponding model type]: Airplane/glider, winglet

This function adjusts the left and right rudder angles of airplanes with winglets.

Winglets are used to improve the efficiency of aircraft lowering the lift-induced drag caused by wingtip vortices. The winglet is a vertical or angled extension at the tips of each wing.

Winglets work by increasing the effective aspect ratio wing without adding greatly to the structural stress and hence necessary weight of its structure - an extension of wing span would also permit lowering of induced drag, though it would cause parasitic drag and would require boosting the strength of the wing and hence its weight - there would come a point at which no overall useful saving would be made. A winglet helps to solve this by effectively increasing the aspect ratio without adding to the span of the wing.

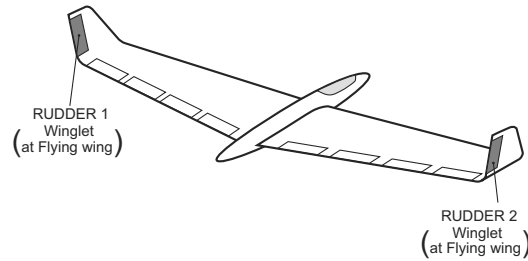

- Select [WINGLET] at the model menu and call the setup screen shown below by pushing the EDIT button.
- Select the function name and return to the preceding screen by pushing the EDIT button.
- The travel at rudder stick left and right operation can be individually set.

WINGLET **CONDIT1** 7.40 1/1

GROUP **GROUP**

FUNCTION	RUDDER LEFT	RIGHT
RUDDER	+100%	+100%
RUDDER2	+100%	+100%

(Rudder 1/2)

- Group/single mode switching (For more information, see the description at the back of this manual.)
- (Currently selected condition name)
- S1 button • Push the **S1** button for 1 second to return to the home screen.
- EDIT dial • Turn the **EDIT** dial to move on the screen.
- EDIT button

- Travel adjustment

Move the cursor to the item you want to adjust and push the EDIT button to switch to the data input mode.

Adjust the rate by turning the EDIT dial.

Push the EDIT button to end adjustment and return to the cursor move mode.

*If the mixing direction is reversed by the linkage, adjustments can be made by changing the mixing rate polarity (+ or -).

MOTOR

[Corresponding model type]: EP glider, general

This function lets you set the operation speed when the motor of a F5B or other EP glider is started by switch. The operation speed can be set in 2 ranges of slow speed flight and high speed flight (Speed 1/Speed 2). This function can also be operated as a safety function by setting 2 switches.

- The In side and Out side operating speeds can be adjusted independently in 2 ranges (Speed 1/Speed 2).
- The boundary between the 2 ranges can be set. (From Speed 1 to Speed 2)
- The set operation speed operation can be activated at initial operation only. (1 time operation) However, operation can be repeated

by setting the switch to OFF before operation is finished. When you want to reset 1 time operation, set the ACT/INH item to [INH] and then reset it to [ON].

- The motor (CH3) is controlled by SW-G. (Initial setting) When changing the switch or stick which controls the motor, first change Function of the Linkage Menu.

Note: When using this function, always check initial operation with the propeller removed.

- Select [MOTOR] at the model menu and call the setup screen shown below by pushing the EDIT button.

- Select the function name and return to the preceding screen by pushing the EDIT button.

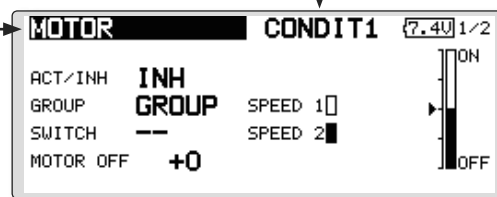

(Currently selected condition name)

- Push the **S1** button to call next page.



- Push the **S1** button for 1 second to return to the home screen.
- Turn the **EDIT** dial to move on the screen.

- Move the cursor by set switch or VR.

- When using this function, move the cursor to the [ACT/INH] item and push the EDIT button to switch to the data input mode. Turn the EDIT dial to the left and push the EDIT button.
- Group/single mode switching (For more information, see the description at the back of this manual.)
- Switch A switch that turns the function itself ON/OFF can be selected.
- Motor off position Press the EDIT button for 1 second when [SW-G] is in the motor OFF position you want to set. The direction of the motor switch is memorized. The screen graph display OFF direction also changes.

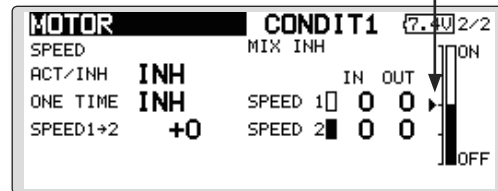

- When using this function, move the cursor to the [ACT/INH] item and push the EDIT button to switch to the data input mode. Turn the EDIT dial to the left and push the EDIT button.
- When you want to set the "One time mode", move the cursor to the [ONE TIME] item and turn the EDIT dial to the left and push the EDIT button.
- Speed 1 to 2 The Speed 1 and Speed 2 region boundary can be changed,
- Operation speed adjustment The speed when Speed 1 and Speed 2 are ON (In) and OFF (Out) can be adjusted.

Notes

- First decide the motor OFF direction, and then set the speed. When you want to reset the motor OFF direction, also reset the speed.
- We recommend that Motor OFF be set in combination with F/S.
- Set the basic operation direction with the Reverse function to match the ESC used.
- Always set the Motor OFF position.

RUD to ELE

[Corresponding model type]: Airplane, general

This function is used when you want to mix elevator operation with rudder operation. It is used to correct undesirable tendencies when rudder is applied in roll maneuvers, knife edge, etc. of stunt planes.

- Link can be set: Links this mixing to other mixings.
- The mixing rate can be fine-tuned by setting a VR. (Fine tuning)

- A mixing curve can be set.
- Mixing during flight can be turned ON/OFF by setting a switch. (Always ON at [-] setting)

- Select [RUD to ELE] at the model menu and call the setup screen shown below by pushing the EDIT button.

(Currently selected condition name)

• Select the function name and return to the preceding screen by pushing the EDIT button.

• Push the **S1** button to call next page.

• Push the **S1** button for 1 second to return to the home screen.

• Turn the **EDIT** dial to move on the screen.

• Mixing curve setting
*For a description of the curve setting method, see the description at the back of this manual.

• Left/right overall adjustment at Rate A and Rate B

- Group/single mode switching

(For more information, refer to the description at the back of this manual.)

*The display screen is an example. The actual screen depends on the model type.

• Fine tuning VR setting

• Operation mode

• Adjustment rate

Setting method

- Move the cursor to the ACT/INH item and push the EDIT button to switch to the data input mode. Turn the EDIT dial to the left and push the EDIT button. (ON is displayed.)
- When setting a switch, move the cursor to the [-] item of the switch and push the EDIT button to call the selection screen, and then select the switch and set its ON direction. (Always ON at "-" setting)
(For a description of the switch selection method, see the description at the back of this manual.)
- When setting a VR, move the cursor to the Fine Tuning "-" item and push the EDIT button to call the selection screen, and then select the VR. The fine tuning rate can be set.
The VR operation mode can also be set.
(For a description of the fine tuning VR setting method, see the description at the back of this manual.)
- When setting Link, move the cursor to the Link

item and push the EDIT button to switch to the data input mode. Set it to ON.

[Fine tuning VR operation mode]

[LIN.] Mixing rate 0% at center of VR. When the VR is turned clockwise and counterclockwise, the mixing rate increases and decreases, respectively.

[ATL+] Mixing rate 0% at left end of VR. When the VR is turned, the mixing rate increases.

[ATL-] Mixing rate 0% at right end of VR. When the VR is turned, the mixing rate increases.

[SYM.] When the VR is turned to the left or right of the neutral position, the mixing rate increases.

SNAP ROLL

[Corresponding model type]: Airplane, general

This function selects the switch and rate adjustment of each rudder, (ailerons, elevators, or flaps) when a snap roll is performed.

- Four snap roll directions can be set. (Right/up, right/down, left/up, left/down)
- Operation mode: When [Master] mode is selected, the Snap Roll function is turned ON/OFF by master switch in the state in which the direction switch was switched to the direction in which you want to snap roll. When [Single] mode is selected, snap roll in each direction can be executed by means of independent switches.
- A safety switch can be set. As a safety measure, the switch can be set so that snap roll is not executed when, for instance, the landing gear is lowered, even if the switch is turned on accidentally. The snap roll switch is activated only when the safety switch is ON.
- The operation speed of the aileron, elevator, and flap servos can be adjusted for each snap roll direction. (In side/Out side)

(Example) Setting example for F3A

- Mode: [Master]
- Safety SW: [SW-G] (Safety measure)
- Master SW: [SW-H] (Main switch for executing snap roll)
- Direction switches:
 - *The snap roll up side left and right and down side left and right direction switches are selected here.
 - Right/Up: OFF [SW-D]
 - Right/Down: OFF [SW-D]
 - Left/Up: OFF [SW-A]
 - Left/Down: OFF [SW-A]
- Speed adjustment

The operation speed of each control surface when the snap switch is ON can be changed and snap roll executed by stick while there is switch operation can be performed.

- Select [SNAP ROLL] at the model menu and call the setup screen shown below by pushing the EDIT button.

• Select the function name and return to the preceding screen by pushing the EDIT button.

SNAP ROLL		CONDIT1		7.40	1/4
RATE	AIL	ELE	RUD		
RIGHT/UP	+100%	+100%	+100%		
RIGHT/DOWN	+100%	-100%	-100%		
LEFT/UP	-100%	+100%	-100%		
LEFT/DOWN	-100%	-100%	+100%		

(Currently selected condition name)

• Push the **S1** button to call next page.

• Push the **S1** button for 1 second to return to the home screen.

• Turn the **EDIT** dial to move on the screen.

SNAP ROLL		CONDIT1		7.40	2/4
MODE	MASTER				
MASTER-SW	--				
SAFETY-SW	--				
GROUP	GROUP				

- Rate adjustment
 1. Move the cursor to the item you want to adjust and push the EDIT button to switch to the data input mode.
 2. Adjust rate by turning the EDIT dial.
 3. Push the EDIT button to end adjustment and return to the cursor move mode.

SNAP ROLL		CONDIT1		7.40	3/4
	ACT	SWITCH			
RIGHT/UP	OFF	--	--		
RIGHT/DOWN	OFF	--	--		
LEFT/UP	OFF	--	--		
LEFT/DOWN	OFF	--	--		

- Group/single mode switching
(For more information, see the description at the back of this manual.)

- Direction switches

SNAP ROLL		CONDIT1		7.40	4/4	
SPEED	AIL	ELE	RUD			
	IN	OUT	IN	OUT	IN	OUT
RIGHT/UP	0	0	0	0	0	0
RIGHT/DOWN	0	0	0	0	0	0
LEFT/UP	0	0	0	0	0	0
LEFT/DOWN	0	0	0	0	0	0

- Adjustment of the servo speed of each rudder
(For a description of the setting method, see the description at the back of this manual.)

MODEL MENU (HELICOPTER)

This section contains information on the commands that apply to helicopters only. For instructions on Airplanes and Sailplanes, refer to the sections pertaining to those aircraft.

Use the Model Type function in the Linkage Menu to select the swash type matched to the fuselage beforehand.

Also, add flight conditions at the Condition Select screen if necessary before setting the model

data at each function. (Up to 8 conditions can be used)

The AFR function, Dual rate function and other functions common to all model types, are described in a separate section.

- Select the [MODEL] at the home screen and call the model menu shown below by pushing the EDIT button.
- Use the EDIT dial to select the function you want to set and call the setup screen by pushing the EDIT button.

- Select the function name and return to the preceding screen by pushing the EDIT button.

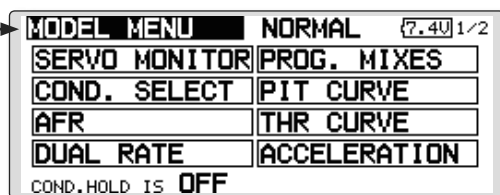

- Push the **S1** button to call next page.
- Push the **S1** button for 1 second to return to the home screen.
- Turn the **EDIT** dial to move on the screen.

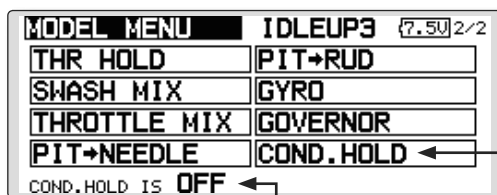

*Condition hold operation is displayed.

To activate/deactivate Condition Hold:

1. Move the cursor to [COND. HOLD].
2. Set the throttle stick lower than the 1/3 point and push the EDIT button to activate/deactivate the condition hold function.

*Refer to for condition hold function details.

Model Menu functions (helicopter) list

PIT CURVE: Adjusts response in different flight conditions

THR CURVE: Throttle curve and hovering trim adjustment

ACCELERATION: Allows a brief "overload" in response to sudden throttle and pitch commands

THR HOLD: Moves the throttle to idle during autorotation

SWASH MIX: Compensates for each control response

THROTTLE MIX: Compensates for power loss when cyclic applied

PIT to NEEDLE: Adjusts response curve in different flight conditions

PIT to RUD: Handles torque changes from pitch angle inputs

GYRO: Used to switch gyro sensitivity

GOVERNOR: Used to switch RPM of the helicopter's head

PIT CURVE/PIT TRIM

PIT Curve

This function adjusts the pitch operation curve for each flight condition for the optimal flight state relative to movement of the throttle stick.

*Up to 17 points can be set for the point curve types. However, when using the 3 points or 5 points specified to create a curve, a simple curve can be created by reducing

the number of input points to 3 or 5, and then entering the specified value at the corresponding points that you created a curve.

- Select [PIT CURVE] at the model menu and call the setup screen shown below by pushing the EDIT button.

- Select the function name and return to the preceding screen by pushing the EDIT button.
- Point curve type is 9 points (initial), but for simple use, 4~5 points are sufficient.
- Push the S1 button to call next page.
- Push the S1 button for 1 second to return to the home screen.
- Turn the EDIT dial to move on the screen.

- Mixing curve setting
 - *For a description of the curve setting method, see the description at the back of this manual.
- Pitch trim copy

- Pitch trim operating position (dotted line)
- Pitch servo speed setting
 - (For a description of the setting method, see the description at the back of this manual.)
- Group/single mode switching
 - (For more information, refer to the description at the back of this manual.)

Normal curve adjustment

- For normal curve, usually use [POINT] type and create a basic pitch curve centered about hovering. Use this function together with the THR Curve (Normal) function and adjust the curve so that up/down control is best at a constant engine speed.

Idle up curve adjustment

- For the high side pitch curve, set the maximum pitch which does overload the engine. For the low side pitch curve, create curves matched to loop, roll, 3D, and other purposes and use the idle up curves according to the performance.

Throttle hold curve adjustment

- The throttle hold curve is used when executing auto rotation dives.

Operation precautions

⚠ WARNING

- ! When actually starting the engine and flying, always set the idle up condition switch to OFF and start the engine in the idling state.

Setting method

- Group/Single item: When you also want to input the same setting contents at other conditions, perform setting in the group mode. In this case, the same contents are input to the other conditions set in the group mode. When you want to set each condition independently, select the single mode (initial setting). Other conditions can be set independently.
- Pit trim copy (Hover/high/low)
The pitch trim operating position can be copied to the pitch curve.
Move the cursor to the [COPY] item and push the EDIT button.
After copying, return the pitch trim to the center to call the last operating position.

Curve setting examples

The screens shown below are curves created by entering the pitch rate at low, center, and high side (3 points or 5 points) at each condition. When actually creating a curve, input the rate specified at the fuselage (or the reference value).

*For a description of the curve setting method, see the description at the back of this manual.

•Pitch Curve (Example)

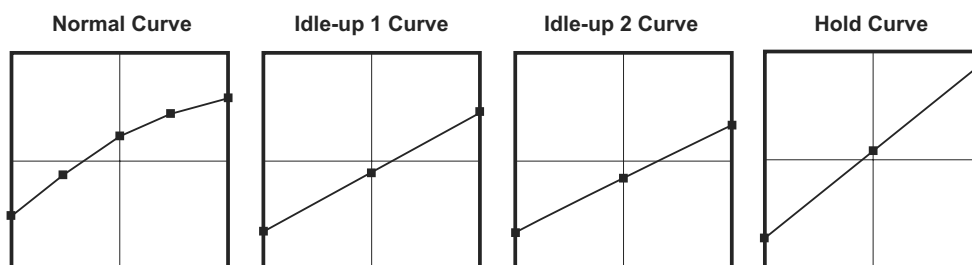

Pitch Trim (Hovering pitch, high pitch, low pitch)

The hovering pitch, low pitch, and high pitch trim setup screen can be called from the PIT Curve setup screen.

- Hovering pitch trim setting

PIT CURVE		NORMAL	{7.50} 2/4
HOVER			
ACT/INH	ON	MODE	CTRM
GROUP	SINGLE	RANGE	100%
CONTROL	LD		
RATE	+30% <-30%		

- Low/High pitch trim setting

PIT CURVE		NORMAL	{7.50} 3/4
LOW PITCH		HIGH PITCH	
ACT/INH	INH	ACT/INH	INH
GROUP	SINGLE	GROUP	SINGLE
CONTROL	--	CONTROL	--
RATE	+30% < +0%	RATE	-30% < +0%

(Continued on next page)

Hovering pitch trim

The Hovering Pitch trim function trims the pitch near the hovering point. Normally, it is used with the hovering condition. The hovering pitch can be fine tuned for changes in rotor speed accompanying changes in temperature, humidity, and other flight conditions. Adjust the hovering pitch so that rotor speed is constant. This function can be used together with the Hovering Throttle Trim function for more delicate operation.

Setting method

- When using only the hovering (normal) condition, switch the group mode to the single mode (initial setting) before setting.
- Set the function to ACT [ON].
- Select the adjustment knob.
Selection example: LD
- The trim operation mode (Mode: CTRM/NORM) can be selected.
CTRM mode: Maximum amount of change near center by center trim operation (recommended)
NORM mode: Normal trim (parallel movement trim) operation. The advantage of using this mode is that the hovering pitch can be adjusted without changing the curve.
- Trim adjustment range (Range) setting
When this value is made small, trim can only be used near the center.
- The trim rate can be adjusted and the operation direction can be changed.

High Pitch/Low Pitch Trim

High Pitch/Low Pitch Trim is the pitch servo high side and low side trim function.

Setting method

- When setting the adjustment knobs common to all the conditions, set them in the group mode.
- Set the function to ACT (ON).
- Select the adjustment knobs.
Selection example: LS (high side), RS (low side)
- The trim rate can be adjusted and the operation direction can be changed.
- Trim acts as high side or low side trim with the center as the standard.

THR CURVE/THROTTLE HOVER TRIM

THR Curve

This function adjusts the throttle operation curve for each condition for optimum engine speed to throttle stick movement.

Up to 17 curve points can be set for the point curve type, however, when the 5 points and other

point data is used, a simple curve can be easily created by reducing the number of input points of the curve to 5 and entering the specified value at the corresponding points.

- Select [THR CURVE] at the model menu and call the setup screen shown below by pushing the EDIT button.

- Select the function name and return to the preceding screen by pushing the EDIT button.

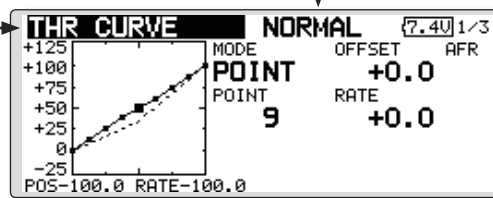

- Push the **S1** button to call next page.

- Push the **S1** button for 1 second to return to the home screen.
- Turn the **EDIT** dial to move on the screen.



- Mixing curve setting
*For a description of the curve setting method, see the description at the back of this manual.

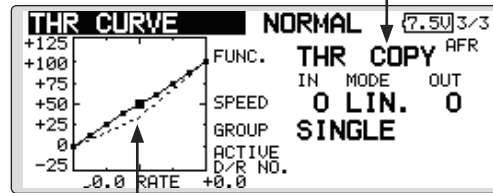

- Throttle hover trim operating position (dotted line)

Normal curve adjustment

- Normal curve creates a basic curve centered around hovering. Use it along with the normal pitch curve and adjust so that up/down control at a constant engine speed is easiest.

Idle up curve adjustment

- Set a idle up curve that maintains a constant speed at all times, even during operation which reduces the pitch performed in flight. Create a curve matched to loop, roll, 3D, or other purposes and the idle up curve according to the performance.

Setting method

- Group/single item: When you want to simultaneously enter the same settings to other functions, make the settings in the group mode. In this case, the same setting contents are entered to the all conditions. When you want to set each condition independently, make the settings after selecting the single mode (Initial setting).

Operation precautions

⚠ WARNING

- When actually starting the engine and flying, always set the idle up condition switch to OFF and start the engine in the idling mode.

- Throttle hover trim copy

The throttle hover trim operating position can be copied to the throttle curve.

Move the cursor to the [COPY] item and push the EDIT button.

After copying, return the pitch trim to the center to call the last operating position.

Curve setting examples

The curves shown below are created by using the point curve type and inputting the data of the 5 points 0% (low side), 25%, 50% (center), 75%, 100% (high) side at each condition. They are created by reducing the number points of the line

to 5. When actually creating a curve, enter the data specified per the aircraft (or the reference value).

*For a description of the curve creation method, see the description at the back of this manual.

•Throttle Curve (Example)

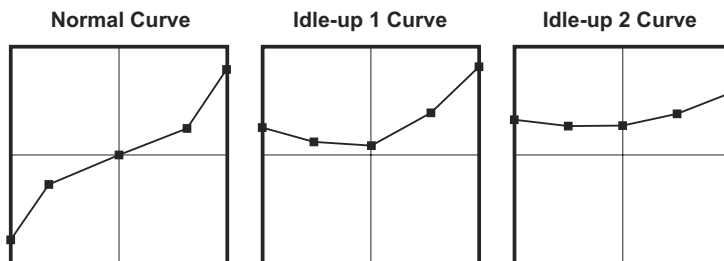

Throttle Hover trim

The Throttle Hover trim setup screen can be called from the THR Curve setup screen.

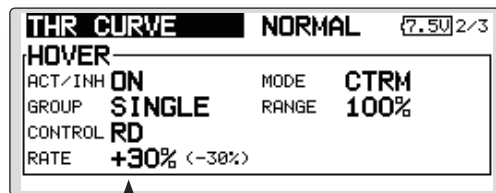

•Sets the dial used.

The Throttle Hover function trims the throttle near the hovering point. Normally, use it with hovering conditions. Changes in rotor speed accompanying changes in the temperature, humidity, and other flight conditions can be trimmed. Adjust the throttle so that rotor rotation is most stable. More delicate trimming is also possible by using this function along with the Hover Pitch function.

Setting method

- When using the hovering (normal) condition only, switch the group mode to the single mode (initial setting) and make the settings.
- Set the function to ACT ([ON]).
- Select the adjustment knob.
Selection example: RD
- The trim operation mode (Mode: CTRM/NORM) can be selected.

CTRM mode: Maximum rate of change

near center by center trim operation (recommended)

NORM mode: Normal trim (horizontal movement trim) operation.

- Trim adjustment range (Range) setting
When the value is made small, trim acts only near the center.
- The trim rate can be adjusted and the operation direction can be set.

ACCELERATION

This function is used to adjust the pitch and the throttle rise characteristic at acceleration/deceleration operation. An acceleration function which temporarily increases the pitch and throttle operations at throttle stick acceleration/deceleration operation can be set.

Example of acceleration function use

- When used at pitch, the Acceleration function is effective when you want to quicken the response of the fuselage at 3D flight flip, etc.
When used, high pitch temporarily exceeds maximum pitch, but immediately returns to maximum pitch.

- Select [ACCELERATION] at the model menu and call the setup screen shown below by pushing the EDIT button.

The diagram illustrates the setup process for the ACCELERATION function. It shows two screens: 'ACCELERATION NORMAL 1/2' for PITCH and 'ACCELERATION NORMAL 2/2' for THROTTLE. The PITCH screen displays settings for ACT/INH (INH), RATE (0%), DUMPING (0%), and ACT POS (25% and 75%). The THROTTLE screen displays settings for ACT/INH (INH), RATE (0%), DUMPING (0%), and ACT POS (25% and 75%). Annotations include: 'Select the function name and return to the preceding screen by pushing the EDIT button.' pointing to the PITCH screen; 'Pitch setting' pointing to the PITCH screen; 'Throttle setting' pointing to the THROTTLE screen; 'Push the S1 button to call next page.' pointing to the S1 button; 'Push the S1 button for 1 second to return to the home screen.' pointing to the S1 button; 'Turn the EDIT dial to move on the screen.' pointing to the EDIT dial; and 'Act position' and 'Current position' pointing to the vertical sliders on the THROTTLE screen.

Setting method

- Acceleration can be set at both setting at acceleration (high) and setting at deceleration (low).
(The operation point is displayed on a graph.)
- Acceleration rate setting (Rate)
- The return time after operation (Dumping) can be set.
- The operation point at acceleration and deceleration can be set. When an operation point is exceeded, acceleration is performed.

Note: When using the Acceleration function, since the pitch stroke is large, make your settings so there is no binding of your linkage.

THR HOLD

This function sets the throttle cut position for auto rotation. The throttle position can also be set to an idling position. Setting of these 2 positions can be selected by switch. This allows use for switching during training.

Example of use

- Since Throttle Hold has 2 modes (Cut) and (Idle), using it in the Idling mode during training and in the Cut mode when stopping the engine at meets, etc. is convenient.

Note: When throttle hold is set to ON in the normal condition, throttle hold acts and the throttle servo is deactivated. Always set throttle hold to ON in the hold condition.

- Select [THR HOLD] at the model menu and call the setup screen shown below by pushing the EDIT button.

- Select the function name and return to the preceding screen by pushing the EDIT button.

- Push the **S1** button to call next page.
- Push the **S1** button for 1 second to return to the home screen.
- Turn the **EDIT** dial to move on the screen.

THR HOLD HOLD 7.5U 1/2

CUT MODE MODE **MANUAL**

ACT/INH **ON**

GROUP **SINGLE** HOLD POS. **17%**

SWITCH **--** SPEED **0**

(Currently selected condition name)

S1 button

EDIT dial

EDIT button

- Set to the engine stop position.

- Hold position
- Current position

THR HOLD HOLD 7.5U 2/2

IDLE MODE MODE **MANUAL**

ACT/INH **INH**

GROUP **SINGLE** IDLE OFFS **+0**

SWITCH **--** SPEED **0**

- Set to the idling position.

Setting method

- Operation mode selection
 - Manual mode(MANUAL):** The throttle hold function is operated by switch operation only.
 - Auto mode(AUTO):** The throttle hold function operation is linked to the throttle stick position.
 - Auto position setting:** When the Auto mode is selected, the throttle position (auto position) can be selected. Move the throttle stick to the position you want to set and push the EDIT button. (Auto position is displayed.)
- Hold position adjustment
 - Throttle Hold (Cut)** sets the throttle cut position. Adjust it so that the carburetor is full close.
 - Throttle Hold (Idle):** Make this adjustment to maintain idling for training. Adjustments can be made based on the throttle curve idle position.

- The throttle servo operating speed can be adjusted. (Speed)
- Throttle cut or training function can be switched by hold function selector switch.

Operation precautions

⚠ WARNING

- When starting the engine, confirm that the idle up condition and throttle hold condition are OFF.

SWASH MIX

The swash mix function is used to correct the swash plate in the aileron (roll) direction and elevator (cyclic pitch) corresponding to each operation of each condition.

Adjustment by independent curve for aileron, elevator, and pitch operations is possible. The operation can be smoothly adjusted by calling up the "Curve setup" screen by pressing the EDIT button with moving the cursor to the mixing item that corresponds to the mixing and direction which needs correction.

Example of use

- As an example, use swash mixing to correct undesirable tendencies in the roll direction
- For a condition which uses AIL to ELE, set this function to ON. When raising the nose at a right roll, when the Rate B side is input and the right aileron is operated, the elevator moves to the down side. Tune by adjusting the Rate. For right roll, adjust to the Rate A side.

- Select [SWASH MIX] at the model menu and call the setup screen shown below by pushing the EDIT button.

- Select the function name and return to the preceding screen by pushing the EDIT button.

(Currently selected condition name)

MIXING	ACT	SWITCH	TRIM	GROUP
AIL→ELE	INH	--	OFF	SINGLE
ELE→AIL	INH	--	OFF	SINGLE
PIT→AIL	INH	--		SINGLE
PIT→ELE	INH	--		SINGLE

- Push the **S1** button for 1 second to return to the home screen.
- Turn the **EDIT** dial to move on the screen.

EDIT button

- Group/single mode switching
(For more information, refer to the description at the back of this manual.)

AIL→ELE		MODE	OFFSET	INH
+150		EXP 1	+0.0	
+100		RATE A	+0.0	
+50		EXP A	+0.0	
0		RATE B	+0.0	
-50		EXP B	+0.0	
-100				
-150				
POS	+0.0	RATE	+0.0	

- Mixing curve setting
*For a description of the curve setting method, see the description at the back of this manual.

Setting method

- When using this function, move the cursor to the [ACT] item and push the EDIT button to switch to the data input mode. Turn the EDIT dial to the left and push the EDIT button. (ON is displayed.)
- When you want to set the same contents at other conditions, select the group mode. When you want to set the selected condition only, select the single mode (initial setting).
- The correction rate can be set by curve.
- A switch can be set.
When [--] is set, the swash mixing function is operated by merely selecting the condition.
When setting an [ON]/[OFF] switch, move

the cursor to the [--] item and push the EDIT button to call the selection screen and set the switch and its ON position.

THROTTLE MIX

This function corrects slowing of engine speed caused by swash plate operation during aileron or elevator operation. The method of applying clockwise or counterclockwise torque when pirouetting can also be corrected.

An acceleration function which temporarily increases the throttle side correction rate relative to rapid stick operation can also be set.

When correction is necessary, move the cursor

- Select [THROTTLE MIX] at the model menu and call the setup screen shown below by pushing the EDIT button.

to the mixing item corresponding to the mixing that needs correction and push the EDIT button to call the curve setup screen, and then correct the slowing.

Setting example

- ALL to THR applies a load to the engine and corrects slowing of the engine speed when the aileron stick was operated. Engine racing can be adjusted independently at the right aileron and left aileron by Rates A and B.

- Select the function name and return to the preceding screen by pushing the EDIT button.

(Currently selected condition name)

THROTTLE MIX NORMAL (7.50) 1/1

MIXING	ACT	SWITCH	MODE	GROUP
AIL→THR	INH	--	CTRM	SINGLE
ELE→THR	INH	--	CTRM	SINGLE
RUD→THR	INH	--	CTRM	SINGLE

- Push the **S1** button to call next page.
 - Push the **S1** button for 1 second to return to the home screen.
 - Turn the **EDIT** dial to move on the screen.
-

- Mixing curve setting
*For a description of the curve setting method, see the description at the back of this manual.

AIL→THR NORMAL (7.40) 1/2

MODE	OFFSET	INH
EXP 1	+0.0	
RATE A	+0.0	+0.0
EXP A	+0.0	+0.0
RATE B	+0.0	+0.0
EXP B	+0.0	+0.0

POS +0.0 RATE +0.0

- Group/single mode switching
(For more information, refer to the description at the back of this manual.)

Setting method

- When using this function, move the cursor to the [ACT] item and push the EDIT button to switch to the data input mode. Turn the EDIT dial to the left and push the EDIT button. (ON is displayed.)
- When you want to set the same contents at other conditions, select the group mode.
When you want to set the selected condition only, select the single mode (initial setting).
- The correction rate can be set by curve.
- A switch can be set.
When [--] is set, the swash mixing function is operated by merely selecting the condition.
When setting an [ON]/[OFF] switch, move the cursor to the [--] item and push the EDIT button to call the selection screen and set the switch and its ON position.

AIL→THR NORMAL (7.40) 2/2

INH

	LEFT	RIGHT
RATE	0%	0%
DUMPING	0%	
ACT POS	-50%	+50%

- Acceleration settings

<Acceleration function setting>

- Acceleration can be set for both settings (Left) and (Right)
- Acceleration rate setting (Rate)
- The return time (Dumping) after operation can be set.
- The operation point when the correction rate is increased and decreased can be set independently. When an operation point is exceeded, acceleration operation is performed.

PIT to NEEDLE mixing

This mixing is used when the engine is equipped with needle control or other fuel-air mixture adjustment. A needle curve can be set.

An acceleration function which temporarily increases needle operation at throttle stick

acceleration/deceleration operation can be set. The rise characteristic of the needle servo at acceleration and deceleration operation can be adjusted.

- Select [PIT to NEEDLE] at the model menu and call the setup screen shown below by pushing the EDIT button.
- Normally, use [POINT] type.
- Push the **S1** button to call next page.
- Push the **S1** button for 1 second to return to the home screen.
- Turn the **EDIT** dial to move on the screen.

- Mixing curve setting
*For a description of the curve setting method, see the description at the back of this manual.

- Group/single mode switching
(For more information, refer to the description at the back of this manual.)

(Currently selected condition name)

- Acceleration settings

Setting method

- When using this function, move the cursor to the [ACT] item and push the EDIT button to switch to the data input mode. Turn the EDIT dial to the left and push the EDIT button. (ON is displayed.)
- When you want to set the same contents at other conditions, select the group mode.
When you want to set the selected condition only, select the single mode (initial setting).
- A needle curve can be set.
- A switch can be set.

When [[-]] is set, the mixing function is operated by merely selecting the condition.

When setting an [ON]/[OFF] switch, move the cursor to the [-] item and push the EDIT button to switch to the data input mode. Push the EDIT button to call the selection screen and set the switch and its ON position.

< Acceleration function setting >

- Acceleration can be set at both setting at acceleration (High) and setting at deceleration (Low).
- The acceleration rate (Rate) and the return time after operation (Dumping) can be set.
- An operation point (Act Pos) at acceleration and deceleration can be set. When an operation point was exceeded, acceleration operation is performed.

PIT to RUD mixing (Revolution mixing)

Use this mix when you want to suppress the reaction torque generated by main rotor pitch and speed changes during pitch operation. Adjust so that the nose does not move in the rudder direction.

An acceleration function which temporarily increases the correction rate at throttle stick acceleration/deceleration operation can be set. The mixing rate at acceleration/deceleration can be set.

However, when a GY Series or other heading hold gyro is used, since correction is performed by the gyro, this mix is not used. If this function is used when the gyro operation mode is the AVCS mode, the neutral position will change.

- Select [PIT to RUD] at the model menu and call the setup screen shown below by pushing the EDIT button.
- Normally, use [POINT] type.
- Push the **S1** button to call next page.
- Push the **S1** button for 1 second to return to the home screen.
- Turn the **EDIT** dial to move on the screen.

• Select the function name and return to the preceding screen by pushing the **EDIT** button.

Setting method

- When using this function, move the cursor to the [ACT] item and push the EDIT button to switch to the data input mode. Turn the EDIT dial to the left and push the EDIT button. (ON is displayed.)
- When you want to set the same contents at other conditions, select the group mode.
When you want to set the selected condition only, select the single mode (initial setting).
- A mixing curve is set.

(Currently selected condition name)

• Acceleration settings

<Normal condition mixing curve>

The mixing curve rate starts from a small value.

For a rotor with a clockwise operation direction (polarity), when pitch was operated at the plus side, set so that mixing is in the clockwise direction. First, trim at hovering and then adjust the neutral position.

1. Adjustment between slow and hovering
Repeatedly hover from take off and land from hovering at a constant rate matched to your own rhythm, and adjust the pitch so the nose does not deflect when the throttle is raised and lowered.
2. Throttle high side (climbing and diving from hovering)
Repeat climbing and diving from hovering at a constant rate matched to your own rhythm and adjust the pitch so that the nose does not deflect when the throttle is raised and lowered.

<Idle up condition mixing curve>

Set the mixing rate so that the rudder direction at high-speed flight is straight ahead. Adjust for each condition used.

<Acceleration function setting>

- Acceleration operation can be performed for both setting at acceleration (High) and setting at deceleration (Low).
- Acceleration rate setting (Rate)
- The return time after operation (Dumping) can be set.
- An operation point (Act Pos) at acceleration and deceleration can be set independently. When an operation point was exceeded, acceleration operation is performed.

GYRO mixing

This function used to adjust gyro sensitivity. The sensitivity and operation mode (Normal mode/GY mode) can be set for each condition.

*Sensitivity setting is assigned to CH3.

Note: Always set to [-] both (Control) and (Trim) for the [Gyro] function at the Function menu of the Linkage Menu.

Setting example

- Normally, it is convenient to preset high sensitivity (Rate 1) and low sensitivity (Rate 2) when either the AVCS mode or Normal mode is used.

- Select [GYRO] at the model menu and call the setup screen shown below by pushing the EDIT button.

(Rate No. display) → (Currently selected condition name)

- Select the function name and return to the preceding screen by pushing the **EDIT** button.
- Gyro type selection: [GY]/[NORM]
- Mode selection: [AVCS]/[NORM]
- Gyro sensitivity adjustment
- Fine tuning VR settings
- Push the **S1** button to call next page.
- Push the **S1** button for 1 second to return to the home screen.
- Turn the **EDIT** dial to move on the screen.

Setting method

- When using this function, move the cursor to the [ACT] item and push the EDIT button to switch to the data input mode. Turn the EDIT dial to the left and push the EDIT button. (ON is displayed.)
- When you want to set the same contents at other conditions, select the group mode. When you want to set the selected condition only, select the single mode (initial setting).
- Three rates can be switched for each condition. (Rate 1/Rate 2/Rate 3)
- A fine tuning VR can be set.

GOVERNOR mixing

When using a Futaba GV-1 governor, this function is used to switch the RPM of the helicopters head. Up to 3 rates can be set for each condition.

- *The governor is used by connecting the governor speed setting channel to CH7 (initial setting).
- *When using an independent governor [ON]/[OFF] switch, connect the AUX([ON]/[OFF]) connector of the governor to CH8 (initial setting) and set the switch to CH8 (Governor2) at the Function menu of the Linkage Menu.

*When using the Fuel Mixture function, the mixture servo is controlled from the governor. When transmitting the mixture curve data from the transmitter to the governor, the governor AUX (m.trim) connector must be connected to CH8 (initial setting) and governor side setting performed. See the governor instruction manual.

Note: Always set (Control) and (Trim) to [--] for [Governor] and [Governor 2] of the Function menu of the Linkage menu.

- Select [GOVERNOR] at the model menu and call the setup screen shown below by pushing the EDIT button.

- Select the function name and return to the preceding screen by pushing the EDIT button.
- Unit display selection: [%]/[rpm]
- RPM adjustment
- Fine tuning VR settings
- Push the S1 button to call next page.
- Push the S1 button for 1 second to return to the home screen.
- Turn the EDIT dial to move on the screen.

Setting method

- When using this function, move the cursor to the [ACT] item and push the EDIT button to switch to the data input mode. Turn the EDIT dial to the left and push the EDIT button. (ON is displayed.)
- When you want to set the same contents at other conditions, select the group mode. When you want to set the selected condition only, select the single mode (initial setting).
- Three speeds (rates) can be set for each condition. (Rate 1/Rate 2/Rate 3)
Also, this mixing and the governor side speed setting must be matched beforehand by the following method:
- Set so that when the governor side is placed in the speed setting item state.
- When you want to read the speed directly, move the cursor to Unit item and push the EDIT button to switch to the data input mode. Turn the EDIT dial to the left and push the EDIT button. ([rpm] is displayed.)

- The speed can be switched by setting a switch. Also, when [--] is set instead of speed setting, the governor can be turned [ON]/[OFF] without setting a separate [ON]/[OFF] switch.
- A speed fine tuning VR can be set.
*VR selection and adjustment rate can be set.

Common operations used in function setup screen

This section describes the functions often used at the function setup screen. Refer to it when setting each function.

Operations related to flight conditions

Group/single mode switching (GROUP/SINGLE)

When setting multiple flight conditions, linking the setting contents with all conditions (group mode) or setting independently (single mode) can be selected. The mode can be changed at the [GROUP] item on each setup screen.

[Group/single mode switching]



1. Use the EDIT dial to move the cursor (reverse-video) to the [GROUP] item on the setup screen and push the EDIT button to switch to the data input mode.

2. Turn the EDIT dial to the left until switch [SINGLE] starts to blink.

*At this point, the mode has still not been changed.

*When changing from [SINGLE] to [GROUP], turn the EDIT dial to the right.

3. Change the mode by pushing the EDIT button.

●Group mode (GROUP)

The same setting contents are set to all the flight conditions.

●Single mode (SINGLE)

Set this mode when the setting contents are not linked with other conditions.

Condition delay setting

Unnecessary fuselage motion generated when there are sudden changes in the servo position and variations in the operating time between channels can be suppressed by using the condition delay function of the condition select function [COND. SELECT].

When the delay function is set at the switching destination condition, a delay corresponding to that amount is applied and the related functions change smoothly.

[Setting method]



*At the condition delay setup screen [COND.DELAY], move the cursor to the [DELAY] item of the channel you want to set and perform the following settings:

1. Switch to the condition you want to set and push the EDIT button to switch to the data input mode.

2. Set the delay by turning the EDIT dial.

Initial value: 0

Adjustment range: 0~27 (maximum delay)

(When the EDIT button is pushed for 1 second, the delay is reset to the initial value.)

3. Push the EDIT button to end adjustment and return to the cursor move mode.

Operations related to fine tuning VR

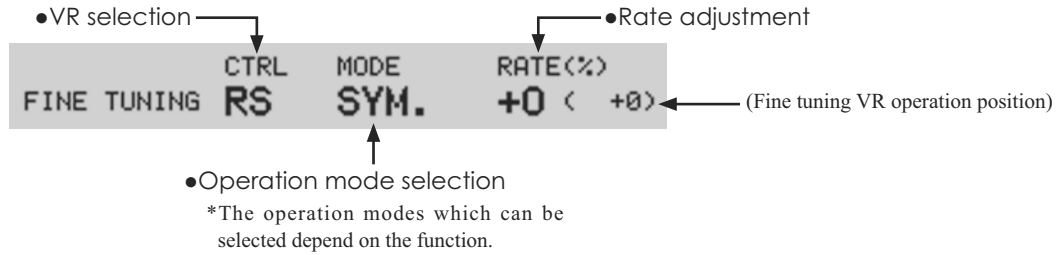

[Setting method]

1. Control selection

Use the EDIT dial to move the cursor (reverse-video) to the [CTRL] item and push the EDIT button to call the selection screen.

Move to the control you want to set by turning the EDIT dial to the left or right and push the EDIT button.

2. Mode selection

Use the EDIT dial to move the cursor to the [MODE] item and push the EDIT button to switch to the data input mode.

Turn the EDIT dial to the left or right and switch to the operation mode ([LIN.], [ATL+], [ATL-], or [SYM.]) corresponding to the set control and push the EDIT button.

3. Rate adjustment

Move the cursor to the [RATE] item and push the EDIT button to switch to the data input mode.

Turn the EDIT dial to the left or right and set the rate.

Initial value: 0%

Adjustment range: -100%~+100%

(When the EDIT button is pushed for 1 second, the rate is reset to the initial value.)

Push the EDIT button to end adjustment and return to the cursor move mode.

[Fine tuning VR operation mode]

[LIN.] Mixing rate 0% at center of VR. When the VR is turned clockwise and counterclockwise, the mixing rate increases and decreases, respectively.

[ATL+] Mixing rate 0% at left end of VR. When the VR is turned, the mixing rate increases.

[ATL-] Mixing rate 0% at right end of VR. When the VR is turned, the mixing rate increases.

[SYM.] When the VR is turned to the left or right of the neutral position, the mixing rate increases.

Operations related to servo speed

Servo speed setting

The servo speed at each function operation (including flight condition switching) can be adjusted. The servos operate smoothly at a fixed speed corresponding to the set speed. The operating speed (IN side) and return speed (OUT side) can be set individually.

Switch the operation mode according to the set function.

"SYM." mode: Used with ailerons and other self neutral functions.

"LIN." mode: Used with functions which hold the operation position of the throttle and switch channel, etc.

[Setting method]



	IN	MODE	OUT
SPEED	0	LIN.	0

1. Use the EDIT dial to move the cursor (reverse-video) to the [MODE] item and push the EDIT button to switch to the data input mode.

Turn the EDIT dial to the left or right and switch to the operation mode ("SYM." or "LIN.") corresponding to the set function and push the EDIT button.

2. Move the cursor to the direction ([IN] or [OUT]) item you want to set and push the EDIT button to switch to the data input mode.

Turn the EDIT dial to the left or right and set the speed.

Initial value: 0

Adjustment range: 0~27 (maximum delay)

(When the EDIT button is pushed for 1 second, the servo speed is reset to the initial value.)

Push the EDIT button to end adjustment and return to the edit mode.

Curve setting operation

This section describes the setting procedure of curves which are used with the AFR function and each mixing function.

Curve type selection

Three types of curves (EXP1, EXP2 and POINT) can be selected.

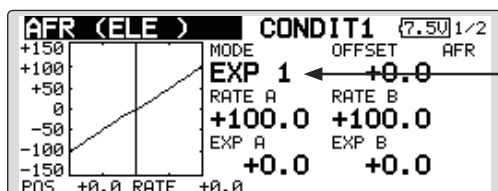

Curve type selection

1. Use the EDIT dial to move the cursor (reverse-video) to the [MODE] item and push the EDIT button to switch to the data input mode.
2. Display the curve you want to use by turning the EDIT dial to the left or right.
 - *The curve type blinks.
3. When the EDIT button is pushed, the curve type is changed. (Operate the EDIT dial or S1 button to stop the change.)
 - [EXP1]: EXP1 curve
 - [EXP2]: EXP2 curve
 - [POINT]: point curve

Setting by curve type

When the curve type is selected as described above, adjustment items corresponding to the curve type appear on the screen. Adjust each curve as described below.

EXP1/EXP2 curve adjustment

(EXP1 curve)

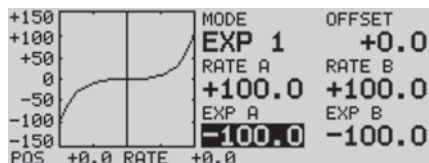

Using the EXP1 curve is effective in smoothing starting of the ailerons, elevator, rudder, etc.

(EXP2 curve)

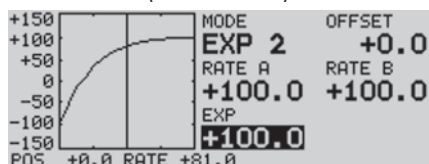

Using the EXP2 curve is effective in engine rise and other engine control.

The curve left and right rates ([RATE A], [RATE B]) and EXP curve rate ([EXP A], [EXP B]) can be adjusted individually. ([EXP] for EXP2)

The curve can also be offset horizontally ([OFFSET]) in the vertical direction.

[Rate setting]

1. Use the EDIT dial to move the cursor

(reverse-video) to the [RATE A], [RATE B], [EXP A], or [EXP B] setting item and push the EDIT button to switch to the data input mode.

2. Set the rate by turning the EDIT dial to the left or right.

Initial value: +100.0% (rate)/+0.0% (EXP rate)

*Initial value differs depending on function.

Adjustment range: -200.0~+200.0% (rate)/-100.0~+100.0% (EXP rate)

(When the EDIT button is pushed for 1 second, the rate is reset to the initial value.)

Push the EDIT button to end adjustment and return to the cursor move mode.

[Offsetting the curve horizontally in the vertical direction]

1. Use the EDIT dial to move the cursor (reverse-video) to the [OFFSET] setting item and push the EDIT button to switch to the data input mode.

2. Move the curve in the vertical direction by turning the EDIT dial to the left or right.

Initial value: +0.0%

(When the EDIT button is pushed for 1 second, the rate is reset to the initial value.)

Push the EDIT button to end adjustment and return to the cursor move mode.

Point curve (POINT) adjustment

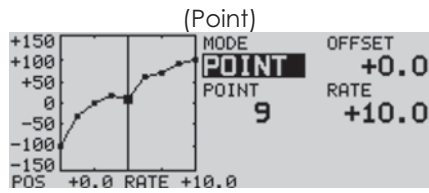

Up to 11 or 17 points curve can be used.
(differs with function)

Initial point number: 9 points (17 points curve), 11 points (11 points curve)

*The set points can be freely increased, decreased, and offset.

[Rate adjustment of each point]

1. Use the EDIT dial to move the cursor (reverse-display) to the [POINT] or [RATE] item and push the EDIT button to switch to the curve setting mode.

*It is changed from the reverse-display to the square box display.

*In this mode, push the EDIT button to switch the [POINT] item and [RATE] item alternately.

2. Move the cursor (square box) to the [POINT] item by pushing the EDIT button.

3. Turn the EDIT dial to the left or right and select the point whose rate you want to set.

*The mark ■ on the curve shows the currently selected point. The mark □ on the curve shows the currently deleted point.

4. Move the cursor (square box) to the [RATE] item by pushing the EDIT button and set the rate by turning the EDIT dial to the left or right.

Repeat steps 2 through 5 and adjust the curve.

Push the S1 button to end adjustment and return to the cursor move mode.

[Point addition]

1. In the curve setting mode, push the EDIT button to move the cursor to the [POINT] item and turn the EDIT dial to the left or right and move the cursor on the curve to the position (mark □) you want to add.

2. When the EDIT button is pushed for 1 second, the point is added.

[Point deletion]

1. In the curve setting mode, push the EDIT button to move the cursor to the [POINT] item and turn the EDIT dial to the left or right and move the cursor on the curve to the position (mark ■) you want to delete.

2. When the EDIT button is pushed for 1 second, the point is deleted.

[Offsetting the curve horizontally in the vertical direction]

1. Use the EDIT dial to move the cursor (reverse-video) to the [OFFSET] item.

2. Move the curve in the vertical direction by turning the EDIT dial to the left or right.

Initial value: +0.0%

(When the EDIT button is pushed for 1 second, the curve is reset to the initial value.)

Push the EDIT button to end adjustment and return to the cursor move mode.

Switch selection method

The various functions used in the T12FG can be selected by switch. The switch (including when stick, trim lever, or VR are used as a switch) setting method is common to all functions.

Switch selection

When a switch is selected at a mixing function, etc., the selection screen shown below is called.

(Switch selection screen example)

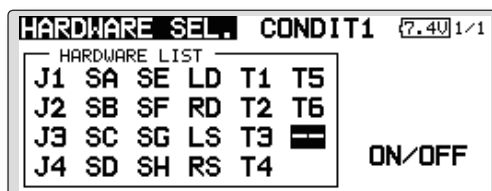

Switch selection

1. Use the EDIT dial to move the cursor (highlights) to the switch you want to select and push the EDIT button.

*The switch blinks.

2. To return to the preceding screen, move the cursor to the [HARDWARE SEL.] at the top of the screen and push the EDIT button.

Or, move the cursor to the [ON/OFF] and call the ON/OFF position setting screen by pushing the EDIT button.

When stick, trim lever, or knob selected

When a stick, trim lever, or knob is used as a switch, four operation modes can be selected by the following mode and type combination:

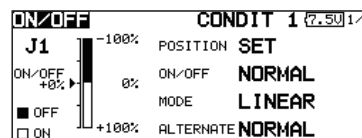

1. When you want to change the mode, move the cursor to [MODE] and push the EDIT button to switch to the data input mode. Switch the display to the mode you want to change by turning the EDIT dial to the left or right and then make the change by pushing the EDIT button.

●Mode: [LINEAR]/[SYMMETRY]

*Set the ON/Off point by the method described on the next page.

When switch was selected

When switch was selected, ON/OFF position setting is also performed.

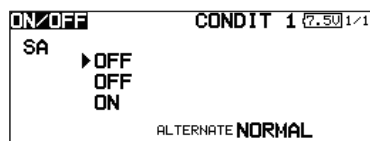

*The ON/OFF setting state of each position is displayed.

1. When you want to change the ON/OFF setting, use the EDIT dial to move the cursor and push the EDIT button to switch to the data input mode. Switch the ON/Off display by turning the EDIT dial to the left or right.

*ON/OFF display blinks.

3. When the EDIT button is pressed, the ON/OFF setting is changed. (Operate the EDIT dial or S1 button to stop the change.)
4. To return to the preceding screen, move the cursor to the [ON/OFF] at the top of the screen and push the EDIT button.

Alternate mode setting

●Mode: [NORMAL]/[ALTERNATE]

1. Move the cursor to the [ALTERNATE] item and push the EDIT button to switch to the data input mode.
2. Change to the mode you want to set by turning the EDIT dial to the left or right.

*The mode display blinks.

3. Push the EDIT button. (Operate the EDIT dial or S1 button to stop the change.)
4. To return to the preceding screen, move the cursor to the [ON/OFF] at the top of the screen and push the EDIT button.

Operation modes

The operation modes when stick, trim lever, or knob was selected are described below.

Linear mode

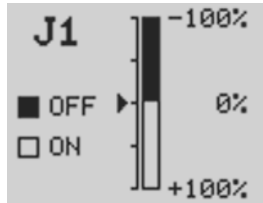

This mode sets ON/OFF at the left or right (up or down) with the set point as the reference.

Symmetrical mode

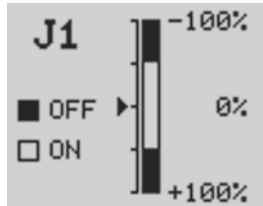

Left and right (up and down) operations are symmetrical about the neutral position. For instance, when you want to switch DR1 with the aileron stick, when the stick is moved to the left or right, DR1 can be turned on at the same left and right position.

Shifting the ON/Off point

The ON/OFF point can be shifted. ON/OFF at a free position can be changed.

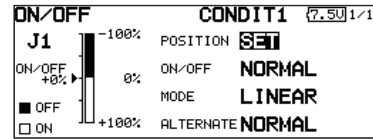

- Black range: OFF range
- White range: ON range

[Setting method]

1. First, use the EDIT dial to move the cursor to the [POSITION] item.
2. Move the stick, trim lever, or knob to the point you want to change and push the EDIT button. The point is shifted.
3. To return to the preceding screen, move the cursor to the [ON/OFF] at the top of the screen and push the EDIT button.

Logic switch (Condition Select function only)

The logic switch function lets you turn operation on and off by combining two switches. For instance, the condition is activated when 2 switches are turned on.

Logic mode

AND: When both switches are ON, the condition is ON.

OR: When either switch is ON, the condition is ON.

EOR: When the two switches are in different states, the condition is ON.

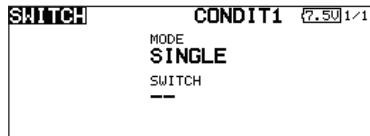

Switch mode selection

1. Move the cursor to the [MODE] item and push the EDIT button to switch to the data input mode.

2. Turn the EDIT dial to the left and select the [LOGIC].

*[LOGIC] display blinks.

3. Push the EDIT button to change to the logic switch mode.

(Logic switch setting screen)

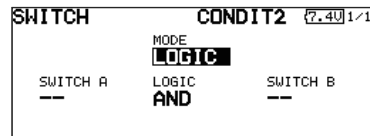

Switch selection

1. Select the switch A and B. (Refer to the description at the previous page.)

Logic mode selection

1. Move the cursor to the [LOGIC] item and push the EDIT button to switch to the data input mode.

2. Turn the EDIT dial to the left or right and select the logic mode.

*The mode display blinks.

3. Push the EDIT button to change to the logic mode.

4. To return to the preceding screen, move the cursor to the [SWITCH] at the top of the screen and push the EDIT button.