

4PX

4PX Telemetry System



INSTRUCTION MANUAL

1M23N29402

Futaba[®]

Digital Proportional R/C System

CE0682

Thank you for purchasing a Futaba 4PX-2.4GHz system.
Before using your 4PX-2.4GHz system, read this manual carefully in order to use your
R/C set safely.

After reading this manual, store it in a safe place.

IN NORTH AMERICA

Please feel free to contact the Futaba Service Center for assistance in operation, use and programming. Please be sure to regularly visit the 4PX Frequently Asked Questions web site at www.futaba-rc.com/faq/. This page includes extensive programming, use, set up and safety information on the 4PX radio system and is updated regularly. Any technical updates and US manual corrections will be available on this web page. If you do not find the answers to your questions there, please see the end of our F.A.Q. area for information on contacting us via email for the most rapid and convenient response.

Don't have Internet access? Internet access is available at no charge at most public libraries, schools, and other public resources. We find internet support to be a fabulous reference for many modelers as items can be printed and saved for future reference, and can be accessed at any hour of the day, night, weekend or holiday. If you do not wish to access the internet for information, however, don't worry. Our support teams are available Monday through Friday 8-5 Central time to assist you.

FOR SERVICE ONLY:

Futaba Service Center
3002 N. Apollo Drive, Suite 1
Champaign, IL 61822
Phone: 217-398-0007
www.futaba-rc.com/service.html
Email: futabaservice@hobbico.com

FOR SUPPORT :

(PROGRAMMING AND USER QUESTIONS)
Please start here for answers to most questions:
www.futaba-rc.com/faq/
Fax: 217-398-7721
Phone: 217-398-8970 option 2
E-mail: support@futaba-rc.com

OUTSIDE NORTH AMERICA

Please contact your Futaba importer in your region of the world to assist you with any questions, problems or service needs.

Please recognize that all information in this manual, and all support availability, is based upon the systems sold in North America only. Products purchased elsewhere may vary. Always contact your region's support center for assistance.

Application, Export, and Modification

1. This product may be used for models only. It is not intended for use in any application other than the control of models for hobby and recreational purposes.

2. Exportation precautions:

(a) When this product is exported from the country of manufacture, its use is to be approved by the laws governing the country of destination for devices that emit radio frequencies. If this product is then re-exported to other countries, it may be subject to restrictions on such export. Prior approval of the appropriate government authorities may be required. If you have purchased this product from an exporter outside your country, and not the authorized Futaba distributor in your country, please contact the seller immediately to determine if such export regulations have been met.

(b) Use of this product with other than models may be restricted by Export and Trade Control Regulations, and an application for export approval must be submitted.

3. Modification, adjustment, and replacement of parts: Futaba is not responsible for unauthorized modification, adjustment, and replacement of parts on this product. Any such changes may void the warranty.

Battery Recycling (for U.S.A.)



The RBRC. SEAL on the nickel-cadmium battery contained in Futaba products indicates that Futaba Corporation is voluntarily participating in an industry-wide program to collect and recycle these batteries at the end of their useful lives, when taken out of service within the United States. The RBRC. program provides a convenient alternative to placing used nickel-cadmium batteries into the trash or municipal waste system, which is illegal in some areas.

(for USA)

You may contact your local recycling center for information on where to return the spent battery. Please call 1-800-8BATTERY for information on NiCd battery recycling in your area. Futaba Corporation involvement in this program is part of its commitment to protecting our environment and conserving natural resources.

RBRC™ is a trademark of the Rechargeable Battery Recycling Corporation.

-
- No part of this manual may be reproduced in any form without prior permission.
 - The contents of this manual are subject to change without prior notice.
 - This manual has been carefully written. Please write to Futaba if you feel that any corrections or clarifications should be made.
 - Futaba is not responsible for the use of this product.

For Your Safety As Well As That Of Others.....8

Explanation of Symbols.....	8
2.4GHz System Precautions.....	8
High Speed Mode Precautions.....	8
Operation Precautions.....	9
Battery Handling Precautions.....	10
Storage and Disposal Precautions.....	11
Other Precautions.....	11

Before Using12

Features.....	12
Set Contents.....	14
Transmitter T4PX.....	15
T4PX Nomenclature.....	15
Power & Display Switch.....	16
Power Off Forgotten Alarm & Auto Power Off.....	16
Low Battery Alarm.....	16
Digital Trim Operation (Wheel).....	17
Digital Trim Operation (Grip).....	17
Mechanical ATL Adjustment.....	18
Wheel & Trigger Tension Adjustment.....	18
Trigger Slide Adjustment & Remove The High Point Spring.....	19
Battery Replacement Method (4 AA Suze Batteries).....	19
When Using The Optional Battery.....	20
When Charging For The Optional Battery.....	20
Display When Power Switch Turned On.....	21
Trim/Dial Lock.....	21
Total Timer.....	21
Changing Wheel Position And Modifying For Left-hand Use.....	22
Using the optional angle spacer.....	28
Trigger brake lever replacement.....	28
Non-telemetry LED (telemetry OFF sign).....	29
Handling the antenna and card slot and receiver.....	29
About T4PX Antenna.....	29
Handling an microSD card (commercial product).....	30
Receiver Terminology.....	31
Receiver Installation.....	31

Installation32

Receiver and Servo Connections.....	32
Installation Safety Precautions.....	33

Initial Set-Up36

Preparations (Transmitter).....36
RF Output & Rx Type Check 36
Receiver Type Change & How To Link 37
Receivers Other Than T-FHSS 39
Servo Type Check 39
Trigger Ratio Check..... 40
Trims Initial Set-Up 40

**For Your Safety
As Well As
That Of Others**

Function Map42

Menu Selection42
Calling The Menu Screen 42
Direct Menu44
Functions List45

**Before
Using**

Functions46

Receiver Setting/Servo Type.....46
Receiver type (T-FHSS/S-FHSS/FASST(C1), Servo type (Digital/Analog) select
Ch. Reverse47
Servo operation reversing
Sub trim48
Servo center position fine adjustment
End Point Adjuster49
End point adjustment
Acceleration (Throttle Acceleration).....52
Function which adjusts the movement characteristic from the throttle neutral position
Fail Safe/Battery Fail Safe Function54
Fail safe, battery fail safe
Steering Curve (EXP)56
Steering operation curve adjustment
Throttle Curve57
Throttle curve adjustment
Steering Speed61
Steering servo delay
Throttle Speed63
Throttle servo delay
Trigger Mode66
Neutral brake function
Throttle servo forward and brake operation proportion setting (Trigger ratio)
Trigger Switch
Idle-Up69
Idle up at engine start
Start Function70
Throttle preset at start function

Installation

**Initial
Set-Up**

**Function
Map**

Functions

Reference

Engine Cut	71
Engine cut off by switch	
A.B.S. Function	73
Pulse brake	
Mixing Menu	78
Brake Mixing	80
Front and rear independent brake control for 1/5GP car, etc.	
Steering Mixing	84
Twin servo steering system	
4WS Mixing	86
For corolla and other 4WS type vehicles mixing	
Gyro Mixing	88
Futaba car rate gyro	
Dual ESC Mixing	90
Front ESC and rear ESC	
CPS-1 Mixing	92
Futaba CPS-1 channel power switch	
Tilt Mixing	94
Outboard engine	
Program Mixing 1,2,3,4,5	96
Programmable mixes between arbitrary channels	
Switch Select	99
Selection of functions operated by push switches	
Dial Select	101
Selection of functions operated by digital dial and digital trim	
Timer Function	104
Up, Fuel down, lap, or lap navigation timer	
Lap List	111
Lap timer data (lap time, average lap time) check	
Model Select	112
Model memory call	
Model Name	113
Model memory name set/modify	
Model Copy	114
Model memory copy	
Data Reset	116
Model memory reset	
MC Link Function (ESC Link)	117
Special function, Futaba ESC (MC960CR, MC851C, MC602C, MC402CR...etc.)	
S.BUS Servo	117
Special function, Futaba S.BUS/S.BUS2 servo parameter setup	

**For Your Safety
As Well As
That Of Others**

**Before
Using**

Installation

**Initial
Set-Up**

**Function
Map**

Functions

Reference

Telemetry System..... 130
Telemetry Menu..... 131
Telemetry :Receiver Battery..... 132
Telemetry :The Drive Battery 133
Telemetry :RPM..... 134
Telemetry :Temperature 135
Sensor Menu 136
Sensor List 136
Sensor Reload 137
Sensor Register 138
Change Slot 139
Condition Function 140
Two kinds of data can be set in one model
Response 142
The operation response can be adjusted
System Menu 143
Display/ Sound/ LED setting/ Battery/ User name/ Data and Time/
Calibrattion/ Information
Display setting..... 144
Sound Setting 146
LED Setting 147
Battery Type Setting 148
User Name..... 149
Data And Time..... 150
Information..... 151
Calibration..... 152
Steering Dual Rate/Throttle ATL "D/R ATL" 154
Steering angle adjustment while running (dual rate)
Brake side adjustment
Auxiliary Channel "CH3", "CH4" 155
Channel 3/4 servo operation position set/check
Servo View 156
Displays servo operation on a bar graph



Reference 157

Specifications 157
Optional Parts 158
Warning Displays 160
When requesting repair (For U.S.A.)..... 162

Use this product in a safe manner. Please observe the following safety precautions at all times.

Explanation of Symbols

The parts of this manual indicated by the following symbols are extremely important and must be observed.

Symbols	Explanation
 Danger	Indicates a procedure which could lead to a dangerous situation and may cause death or serious injury if ignored and not performed properly.
 Warning	Indicates procedures which may lead to dangerous situations and could cause death or serious injury as well as superficial injury and physical damage.
 Caution	Indicates procedures that may not cause serious injury, but could lead to physical damage.

Symbols:

 : Prohibited

 : Mandatory

2.4GHz System Precautions

Warning

 Special attention should be paid before turning on the system while other cars are running or other airplanes are flying because the 2.4GHz RC system could potentially affect them.

 Be sure to set the Fail Safe function.

Digital Servo Type Precautions

Caution

 When using the 4PX in the "Digital servo" type, always use it under the following conditions:

Servos :Futaba digital servo (including BLS Series brushless servos)

Receiver's battery :Matched to the ratings of the receiver and connected digital servo (dry cell battery cannot be used).

Transmitter mode :Digital servo type(See p.39 for setting method.)

Under other conditions, the set will not operate, or the specified performance will not be displayed even if it operates. In addition, it may cause servo trouble. Futaba will not be responsible for damage, etc. caused by combination with the products of other companies.

In addition, the FSU Fail Safe Unit cannot be used because the system is different. Use the fail safe function of the transmitter.

 When using analog servos, always switch the 4PX servo type to the "Analog servo" mode.

Transmitter mode :Analog servo type(See p.39 for setting method.)

Receiver's battery :Matched to the ratings of the receiver and connected servo.

The set cannot operate in the "Digital servo" type. Operation in this type will cause trouble with the servo and other equipment.

Digital servos (including BLS Series brushless servos) can also be used in the "Analog servo" type.

Operation Precautions

Warning

- ⊘ Do not operate outdoors on rainy days, run through puddles of water or use when visibility is limited.

Should any type of moisture (water or snow) enter any component of the system, erratic operation and loss of control may occur.

- ⊘ Do not operate in the following places.
 - Near other sites where other radio control activity may occur.
 - Near people or roads.
 - On any pond when passenger boats are present.
 - Near high tension power lines or communication broadcasting antennas.

Interference could cause loss of control. Improper installation of your Radio Control System in your model could result in serious injury.

- ⊘ Do not operate this R/C system when you are tired, not feeling well or under the influence of alcohol or drugs.

Your judgment is impaired and could result in a dangerous situation that may cause serious injury to yourself as well as others.

- ⊘ Do not touch the engine, motor, speed control or any part of the model that will generate heat while the model is operating or immediately after its use.

These parts may be very hot and can cause serious burns.

- ① Always perform an operating range check prior to use.

Problems with the radio control system as well as improper installation in a model could cause loss of control.

(Simple range test method)

Have a friend hold the model, or clamp it down or place it where the wheels or prop cannot come in contact with any object. Walk away and check to see if the servos follow the movement of the controls on the transmitter. Should you notice any abnormal operation, do not operate the model. Also check to be sure the model memory matches the model in use.

- ① Turning on the power switches.
Always check the throttle trigger on the transmitter to be sure it is at the neutral position.

1. Turn on the transmitter power switch.
2. Turn on the receiver or speed control power switch.

Turning off the power switches

Always be sure the engine is not running or the motor is stopped.

1. Turn off the receiver or speed control power switch.
2. Then turn off the transmitter power switch.

If the power switches are turned off in the opposite order, the model may unexpectedly run out of control and cause a very dangerous situation.

- ① When making adjustments to the model, do so with the engine not running or the motor disconnected.

You may unexpectedly lose control and create a dangerous situation.

(Fail safe function)

- ① Before running (cruising), check the fail safe function.

Check Method; Before starting the engine, check the fail safe function as follows:

- 1) Turn on the transmitter and receiver power switches.
- 2) Wait at least one minute, then turn off the transmitter power switch. (The transmitter automatically transfers the fail safe data to the receiver every minute.)
- 3) Check if the fail safe function moves the servos to the preset position when reception fails.





The fail safe function is a safety feature that minimizes set damage by moving the servos to a preset position when reception fails. However, if set to a dangerous position, it has the opposite effect. When the reverse function was used to change the operating direction of a servo, the fail safe function must be reset. Setting example: Throttle idle or brake position

Battery Handling Precautions







(Only when Ni-MH/Li-ion batteries are used)

For Your Safety As Well As That Of Others

Warning

-  Never plug the charger into an outlet of other than the indicated voltage.
Plugging the charger into the wrong outlet could result in an explosion or fire.
-  Never insert or remove the charger while your hands are wet.
You may get an electric shock.
-  Do not use the transmitter's battery, HT5F1700B or FT2F1700BV2 as the receiver's battery.
Since the transmitter's battery has an overload protection circuit, the output power will be shut down when the high current load is applied. This may result in runaway or fatal crash.
-  Always check to be sure your batteries have been charged prior to operating the model.
Should the battery go dead while the model is operating, loss of control will occur and create a very dangerous situation.
-  To recharge the transmitter battery, use the special charger made for this purpose.
Overcharging could cause the battery to overheat, leak or explode. This may lead to fire, burns, loss of sight and many other types of injuries.

Caution

-  When running (cruising), do not use the dry cell battery box at the transmitter.
The accessory dry cell battery box is for performance checks. Do not use it for other than performance checks. The dry cell battery may be separated from the battery box contacts by shock and the power cut off. If the power is cut off while running (cruising), a collision may occur. The use of Futaba a genuine NiMH or LiFe battery pack is strongly recommended.
-  Do not use commercial AA size Ni-MH and Li-ion batteries.
Quick charging may cause the battery contacts to overheat and damage the battery holder.
-  Do not short circuit the battery terminals.
A short circuit across the battery terminals may cause abnormal heating, fire and burns.
-  Do not drop the battery or expose it to strong shocks or vibrations.
The battery may short circuit and overheat; electrolyte may leak out and cause burns or chemical damage.
-  When the model is not being used, always remove or disconnect the battery.
Leaving the battery connected could create a dangerous situation if someone accidentally turns on the receiver power switch. Loss of control could occur.
-  Always keep the charger disconnected from the outlet while it is not in use.
Do this to prevent accidents and to avoid overheating.
-  Do not connect the charger when the battery is not connected.
A load will be applied to the circuit and the transmitter may be damaged.

Storage and Disposal Precautions

Warning

- ⊘ Do not leave the radio system or models within the reach of small children.

A small child may accidentally operate the system. This could cause a dangerous situation and injuries. Ni-Cd batteries can be very dangerous when mishandled and cause chemical damage.

- ⊘ Do not throw Ni-MH/LiFe batteries into a fire. Do not expose batteries to extreme heat. Also do not disassemble or modify a battery pack.

Overheating and breakage will cause the electrolyte to leak from the cells and cause skin burns, loss of sight, and other injuries.

- ❗ When the system will not be used for any length of time, store the system with HT5F1700B batteries in a discharged state. Be sure to recharge the batteries prior to the next time the system is used.

If the batteries are repeatedly recharged in a slightly discharged state, the memory effect of the Ni-Cd battery may considerably reduce the capacity. A reduction in operating time will occur even when the batteries are charged for the recommended time. (After discharge to 1 cell E.V.=1V)

<Battery Electrolyte>

The electrolyte in Ni-MH/Ni-Cd batteries is a strong alkali. Should you get even the smallest amount of the electrolyte in your eyes, DO NOT RUB. Wash immediately with water, and seek medical attention at once. The electrolyte can cause blindness. If electrolyte comes in contact with your skin or clothes, wash with water immediately.

Warning

- ⊘ Do not store your R/C system in the following places.

- Where it is extremely hot or cold.
- Where the system will be exposed to direct sunlight.
- Where the humidity is high.
- Where vibration is prevalent.
- Where dust is prevalent.
- Where the system would be exposed to steam and condensation.

Storing your R/C system under adverse conditions could cause deformation and numerous problems with operation.

- ❗ If the system will not be used for a long period of time, remove the batteries from the transmitter and model and store in a cool, dry place.

If the batteries are left in the transmitter, electrolyte may leak and damage the transmitter. This applies to the model also. Remove the batteries from it also to prevent damage.

<Battery Recycling>

A used battery is a valuable resource. Insulate the battery terminals and dispose of the battery by taking it to a battery recycling center.

Other Precautions

Caution

- ⊘ Do not expose plastic parts to fuel, motor spray, waste oil or exhaust.

The fuel, motor spray, waste oil and exhaust will penetrate and damage the plastic.

- ❗ Always use only genuine Futaba transmitters, receivers, servos, ESCs (electronic speed controls), Ni-MH/Ni-Cd/Li-ion batteries and other optional accessories.

Futaba will not be responsible for problems caused by the use of other than Futaba genuine parts. Use the parts specified in the instruction manual and catalog.

Features

-High balance design

Rigidity is improved and weight is lightened 15g from that of the previous model by design that effectively impacts the age and the use of aluminum at part of the frame.

-Full color LCD

Excellent outdoor visibility OVGA3.5 inch backlighted color TFT liquid crystal. Enlarged display improves visibility tremendously.

-High response & telemetry T-FHSS

Increased response T-FHSS transmission increases response by 30% over that of the previous model. In addition, receiver power supply voltage and other information from the receiver can be displayed at the transmitter by fast, stable bidirectional transmission.

-Updateable software

Software can be updated by microSD card. Model data can also be saved in a microSD card. In addition, telemetry log data can be saved.

-Model memory for 40 models

Model names can use up to 10 letters, numbers, and symbols, so that logical names may be used. A model memory with different setups can be created by using the model copy function.

-Brake mixing for large cars

Brake mixing of the front and rear wheels of 1/5GP and other large cars can be adjusted independently.

-Steering mixing

Smooth cornering is possible by independent left and right steering servo setting.

-4WS mixing for crawlers and other 4WS type

This function can be used with crawlers and other 4WS type vehicles.

-Dual ESCs mixing for crawlers cars

ESC at the front and rear are controlled independently.

-Gyro mixing

The sensitivity of Futaba car rate gyros can be adjusted from the T4PX.

-CPS mixing

LED lighting and flashing control using our CPS-1 channel power switch can be matched to steering and throttle operation by switch only.

-S.BUS servo

This is a special function that allows setting of the parameters of our S.BUS servo whose settings are changed by using PC Link software.

-MC-Link

This is a dedicated function which allows setting of the contents of the Link software which makes possible Futaba speed controller (ESC), MC960CR, MC950CR, MC850C, MC851C, MC602C, MC402CR, etc. variable frequency and other data changes by PC at the T4PX.

-Response change function

The operation response can be set in 50 steps to match your preference and the course and vehicle.

-Anti-skid braking system (A.B.S.)

This function applies the brakes so that the tires of gasoline engine cars, etc. do not lose their grip on the road even when braking at corners.

-Throttle acceleration

Gasoline engine cars have a time lag before the clutch and brakes become effective. The TH-ACCEL function reduces this time lag.

-Throttle speed

Sudden trigger operation on a slippery road surface will only cause the tires to spin and the model to not accelerate smoothly. By setting the throttle speed function, operation can be performed smoothly and easily. It also suppresses battery consumption.

-Steering speed

When you sense that the steering servo is too fast, etc., the servo operating speed (direction that suppresses the maximum speed) can be adjusted.

-Non-telemetry LED

When the telemetry function is OFF to confirm that the telemetry function is not operating.

-Racing timer

The lap timer can record 99 lap times, total time, and average lap time. The timer can also be started automatically by trigger operation. The race time and audible alarm can be set. The 4PX also has a navigation timer effective during practice runs. The target lap and re-/fueling time are indicated by an audible alarm. An up timer and down timer are also provided.

-Function select dial function

This function assigns functions to dials (digital trim, grip dial, knob). The step amount and operating direction can also be adjusted. Trim positioning at each model call is unnecessary because all the dials are digital.

-Function select switch function

This function assigns functions to 3 switches. The operating direction can also be set.

-Wheel & Trigger position can be changed

The wheel position can be offset by using an accessory APA wheel position offset adapter. The wheel angle can also be adjusted. The position of the throttle trigger can be moved forward and backward.

-Trigger brake lever replacement

The trigger brake lever is selected from a narrow nylon type and wide type

-Edit button lock & trim/dial lock functions

Lock functions which prohibit setting and operation by transmitter edit buttons, trim, and dials are provided.

-Left-handed support

The left and right installation direction of the wheel section can be reversed.

-Tension adjustment function

The tension of the steering wheel & throttle trigger springs can be adjusted from the outside.

Set Contents

After opening the box, first check if the contents conform to the following. The contents depend on the set as shown below.

Transmitter	T4PX
Receiver	R304SB or R304SB-E
Miscellaneous	<p>Dry battery holder *Installed in transmitter.</p> <p>Wheel offset adapter(APA)</p> <p>Wheel adapter 32deg</p> <p>Trigger brake lever (narrow type)</p> <p>Miniature screwdriver</p> <p>Instruction manual</p>

- If any of the set contents are missing, or you have any questions, please contact your dealer.

Caution

❗ When using the T4PX in the "Digital servo" type, always use it under the following conditions:

Servos:Futaba digital servo (including BLS Series brushless servos)

Receiver's battery:Matched to the ratings of the receiver and connected digital servo (dry cell battery cannot be used).

Transmitter servo type:Digital servo type (See page 39 for setting method.)

Under other conditions, the set will not operate, or the specified performance will not be displayed even if it operates. In addition, it may cause servo trouble. Futaba will not be responsible for damage, etc. caused by combination with the products of other companies.

In addition, the FSU Fail Safe Unit cannot be used because the system is different. Use the fail safe function of the transmitter.

❗ When using analog servos, always switch the T4PX servo type to the "Analog servo" type.

Transmitter mode:"Analog servo" type (See page 39 for setting method.)

Receiver's battery:Matched to the ratings of the receiver and connected digital servo.

The set cannot operate in the "Digital servo" type. Operation in this type will cause trouble with the servos and other equipment. Digital servos (including BLS Series brushless servos) can also be used in the "Analog servo" type.

❗ Always use only genuine Futaba transmitters, receivers, servos, ESCs (electronic speed controls), Ni-MH/Ni-Cd/Li-ion batteries and other optional accessories.

Futaba will not be responsible for problems caused by the use of other than Futaba genuine parts. Use the parts specified in the instruction manual and catalog.

Transmitter T4PX

Nomenclature

*The switches, dial, and trimmers in the figure are shown in the initial setting position.

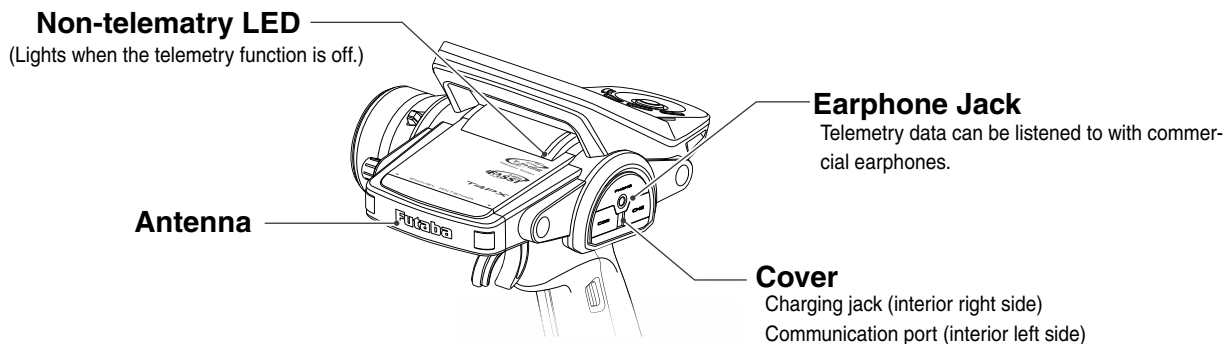
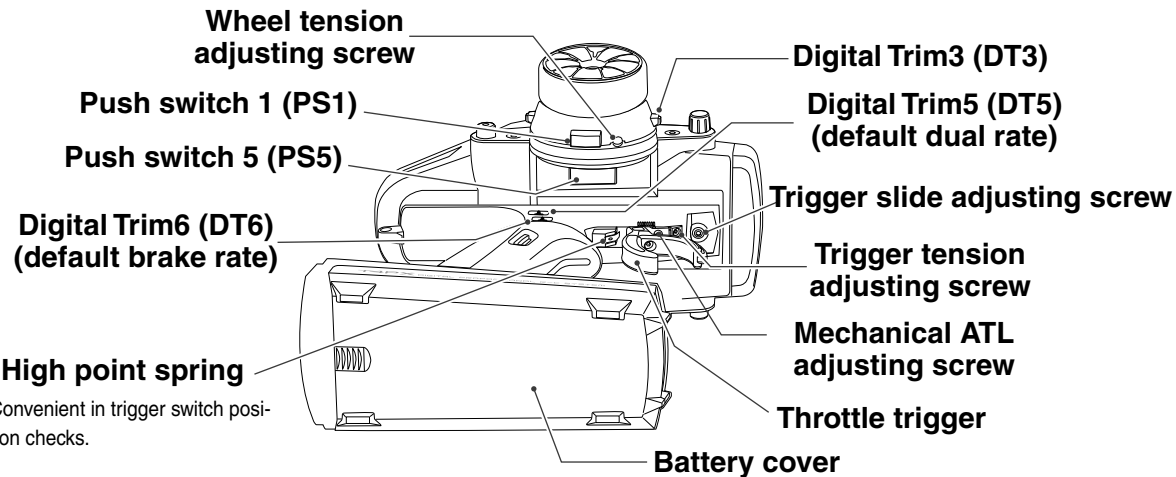
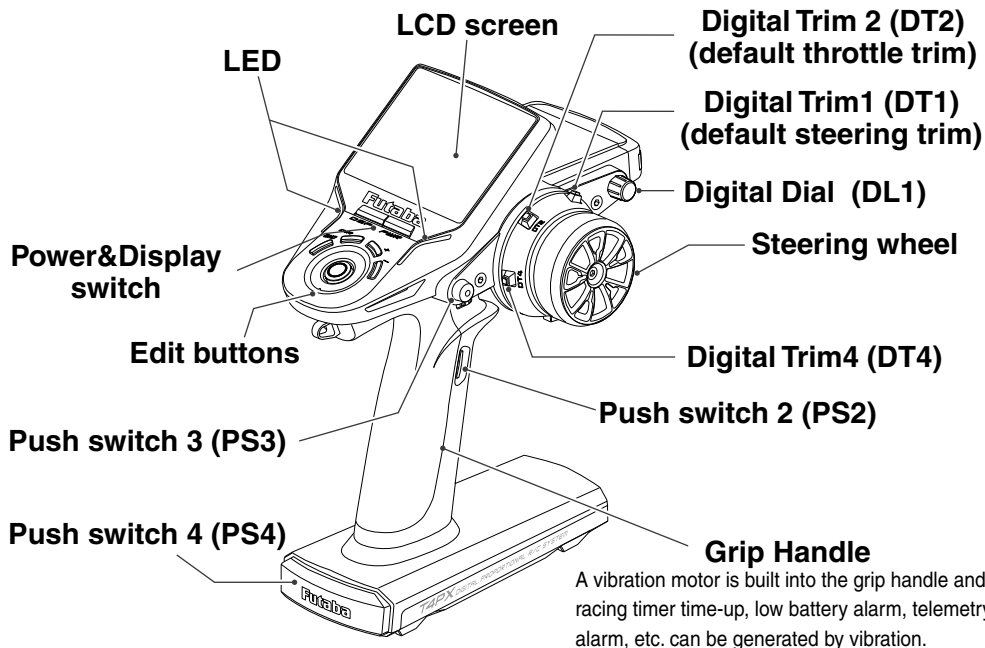

Before Using

Power & Display Switch

The power switch and display switch are push switches.

When the power switch (PWR) is held down, operation starts by transmitting radio waves. When the display switch is held down, the transmitter side data can be checked and set. When the power is turned off, if the power switch or display switch is held down, the power is turned off. If both switches are pressed simultaneously, the power is turned off quickly.

"T-FHSS, S-FHSS, FASST" is displayed



"Display" is displayed

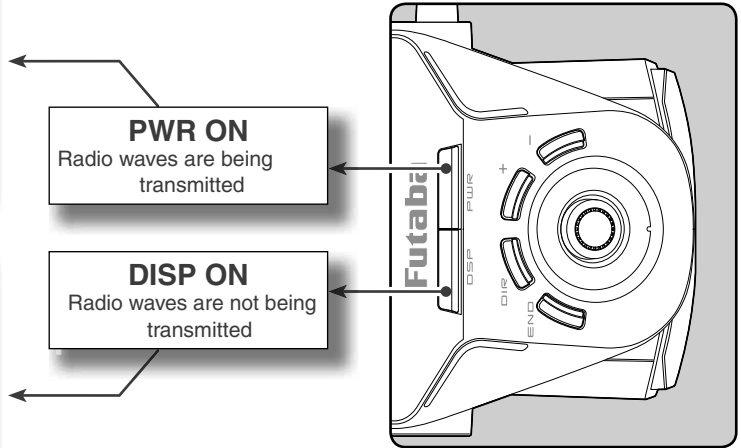

PWR ON
Radio waves are being transmitted

DISP ON
Radio waves are not being transmitted

Before Using

Power Off Forgotten Alarm & Auto Power Off

At T4PX initialization, if steering wheel, throttle trigger, push switch, edit button, or other operation is not performed within 10 minutes, an audible alarm will sound and the message "Warning: Auto power off" will appear.

If steering wheel, throttle trigger, push switch, edit button or other operation is performed, the alarm is reset. Also turn off the power when the transmitter is not in use. If the alarm is not reset, the auto power off function will automatically turn off the power after 5 minutes. If you do not want to use this alarm and the auto power off function, they can be disabled by system setting (p.148).



Low Battery Alarm

If the transmitter battery voltage drops below the usable range, an audible alarm will sound and "Low battery" will be displayed. Since the usable range of LiFe and NiMH batteries and LiFe batteries is different, the power supply used must be set by system setting. If the battery goes dead while running (cruising), since there is the danger of collision, immediately recover the vehicle (boat) and stop running (cruising).

⚠ Warning

① When a low battery alarm is generated, cease operation immediately and retrieve the model.

If the battery goes dead while in operation, you will lose control of the model.



Digital Trim Operation (Wheel)

(Initial settings: DT1: Steering trim, DT2: Throttle trim, DT3: Channel 3, DT4: Channel 4)

Operate digital trim by tilting each trim lever up and down or left and right. The current trim position is displayed on the LCD screen. However, operation is impossible when trim/dial lock (P21) is set.

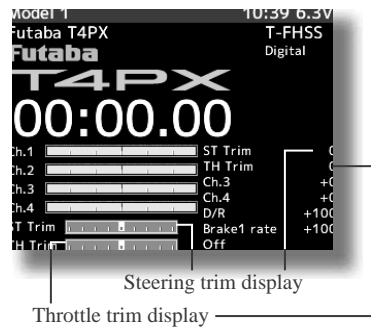
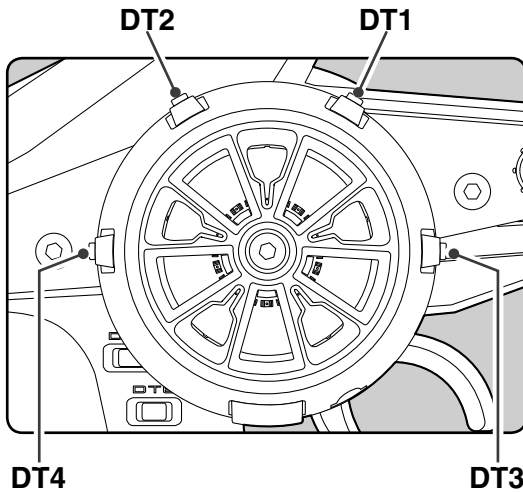

- Each step is indicated by a tone.
- When the trim exceeds the maximum trim adjustment range, the beep will change and the servo will not move any farther. Return to the neutral position (center) by pressing both the push button switches simultaneously for about one second.
- Reset when tilted to the transmitter body side while pressing each trim button in the wheel center direction.

Trim Operation

With the center trim feature, trim adjustments have no effect on the maximum servo travel. This prevents the linkages from binding when adjustments are made.

Digital Trim Operation (Grip)

(Initial setting: DT5; Steering D/R, DT6; Brake rate)

Operate the lever by turning them. The current set value is displayed on the LCD screen. However, this operation cannot be performed when the trim/dial lock (p.21) function is set.

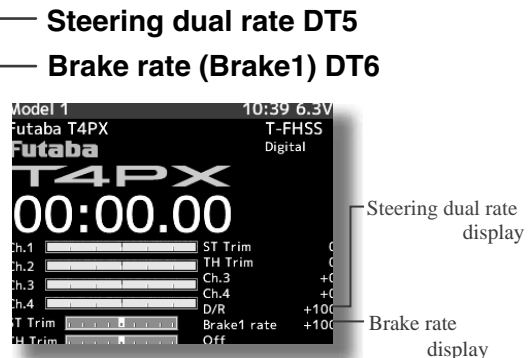
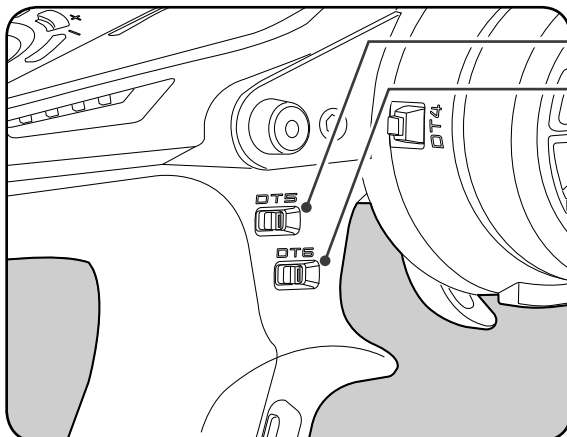

- Each step is indicated by a tone.
- When the trim exceeds the maximum trim adjustment range, the tone will change pitch and the servo will not move any farther.

Mechanical ATL Adjustment

Make this adjustment when you want to decrease the stroke of the brake (back) side of the throttle trigger for operation feel.

Adjustment

1 Using a 1.5mm hex wrench, adjust the trigger brake (reverse) stroke. (The screw moves the throttle trigger stopper.)

- When the screw is turned clockwise, the stroke becomes narrower. Adjust the stroke while watching the screw.

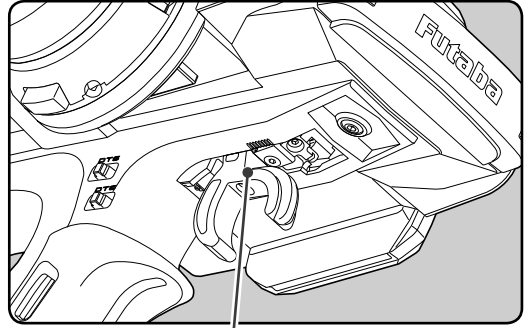

**Mechanical ATL
adjusting screw**

Note:

Once you have changed the mechanical stroke on the brake side, be sure to adjust the scale of the throttle channel accordingly by using the "Adjuster Function" (p.128).
Due to this change, you also need to adjust in most cases the travel of the throttle servo by using "Data Setting."

Wheel & Trigger Tension Adjustment

Make this adjustment when you want to change the wheel or trigger spring's tension.

Adjustment

1 Using a 1.5mm hex wrench, adjust the wheel spring tension by turning the screw inside the adjusting hole in the arrow direction.

- The spring is set to the weakest tension at the factory.
- When the adjusting screw is turned clockwise, the spring tension increases.

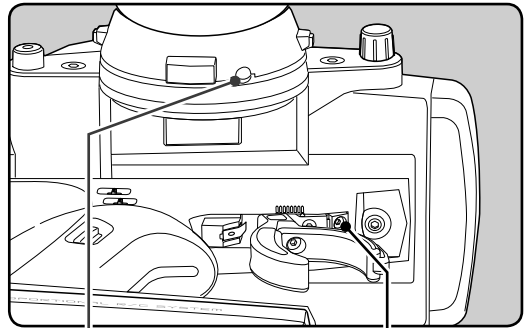

**Wheel tension
adjusting screw**

**Trigger tension
adjusting screw**

Note:

The adjustment range is up to 7 to 8 turns from the fully tightened (strongest) position. If turned farther than this, the adjusting screw may fall out.

Trigger Slide Adjustment & Remove The High Point Spring

The throttle trigger position can be moved forward and backward.

Adjustment

- 1 Using a 2.0mm hex wrench, loosen the trigger slide mounting screw by turning it slightly counterclockwise.

Always loosen this screw.

Note:

If the trigger slide screw is turned too much, the screw may fall out.

- 2 Adjust the trigger slide position within the marked range.

The high point spring can be removed by moving to the fastest from the grip.

When the high point spring was removed, perform throttle side correction by adjuster function (p.152).

- 3 Retighten the mounting screw loosened at step 1 and fasten the trigger slide.

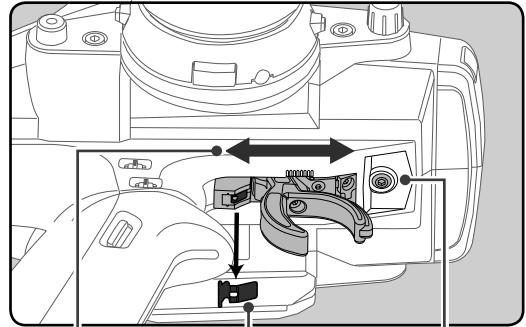

Please adjust it within the range of mark.

Trigger slide mounting screw

High point spring can be removed with radio pliers, etc.

Battery Replacement Method (4 AA Size Batteries)

Load the four batteries in accordance with the polarity markings on the battery holder.

Battery Replacement Method

- 1 Remove the battery cover from the transmitter by sliding it in the direction of the arrow in the figure.
- 2 Remove the used batteries.
- 3 Load the new AA size batteries. Pay very close attention to the polarity markings and reinsert accordingly.
- 4 Slide the battery cover back onto the case.

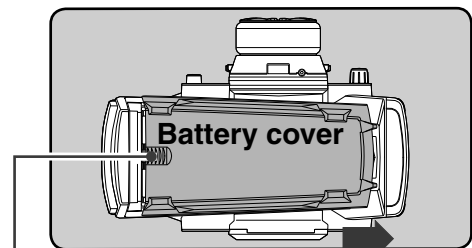

Slide battery cover while pressing here.

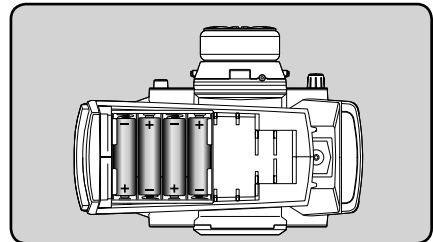

⚠ Caution

- ⊗ When running (cruising), do not use the dry cell battery box at the transmitter.

The accessory dry cell battery box is for performance checks. Do not use it for other than performance checks. The dry cell batteries will be separated from the battery box contacts by shock and the power may be cut off. There is the danger of collision if the power is cut while running (cruising). The use of Futaba genuine NiMH or LiFe batteries is strongly recommended.

When Using The Optional Battery

When using an optional rechargeable battery, replace the battery as described below.

- Always use the optional HT5F1800B, FT2F1700BV2, FT2100BV2 rechargeable battery.
- The type of power source used must be set by system setting (p.148).
- When the transmitter will not be used for a long time, remove the battery.

Battery Replacement Method

- 1** Refer to the previous description and remove the transmitter battery cover.
- 2** After removing the dry cell battery box from the transmitter, disconnect the connector.
- 3** Insert the connector of the new battery and load the new battery into the transmitter.
- 4** Finish by installing the battery cover.

Caution

- ❗ When closing the battery cover, be careful that the battery cover does not pinch the battery lead wires.
- Shorting of the battery lead wires may lead to fire and abnormal heating and cause burns or fire disaster.

When Charging For The Optional Battery

Charge Of A NiMH Battery

(Example: When using the HT5F1800B with the special charger)

- 1** Plug the transmitter cord of the special charger into the charging jack on the rear of the transmitter.
- 2** Plug the charger into an AC outlet.
- 3** Check that the charging LED lights.

Charge Of A LiFe Battery

(Example: When using the FT2F1700BV2/2100BV2 with the special charger)

- 1** Remove the battery cover.
- 2** Disconnect the battery from the T4PX.
- 3** Balance charging cannot be done through the transmitter, you must remove the LiFe battery to do this.

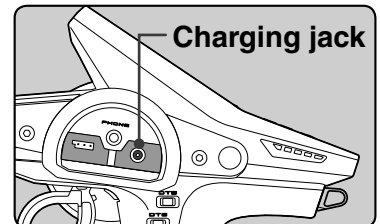
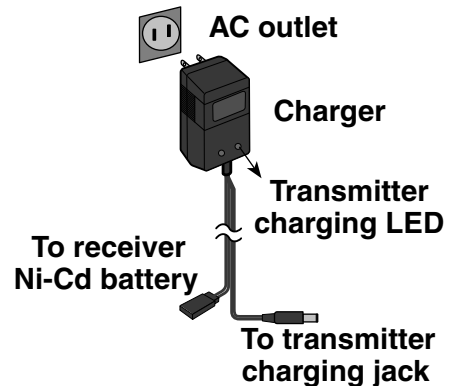

Warning

- ⊗ Never plug it into an outlet other than the indicated voltage.
Plugging the charger into the wrong outlet could result in an explosion or fire.
- ⊗ Do not insert and remove the charger when your hands are wet.
It may cause an electric shock.
- ❗ Always use the special charger or a quick charger for digital proportional R/C sets to charge a digital proportional R/C set Ni-MH or LiFe battery.
Overcharging a Ni-MH battery can result in burns, fire, injuries, or loss of sight due to overheating, breakage, or electrolyte leakage.

⚠ Caution

⊘ When the charger is not in use, disconnect it from the AC outlet.

Do this to prevent accidents and to avoid overheating.

⦿ If the power is turned on during charging, an RF error will be displayed and an audible alarm will sound. Immediately turn off the power. (See p.161)

Display When Power Switch Is Turned On

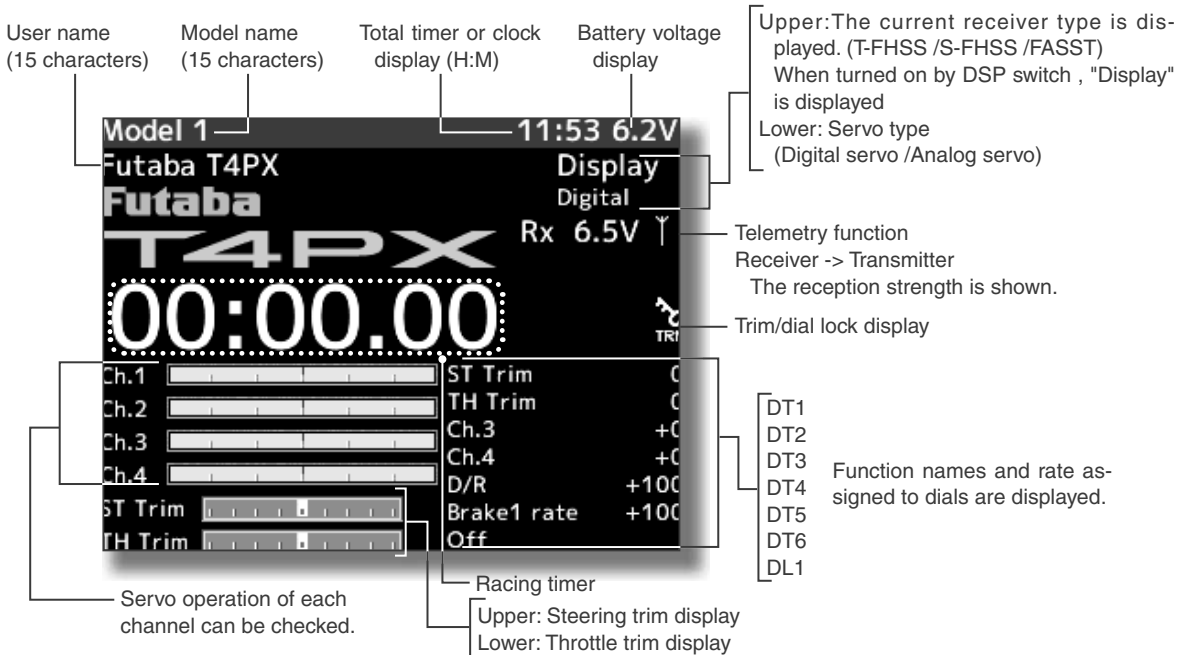

Trim/Dial Lock

T4PX setup and operation by digital trim DT1, DT2, DT3, DT4, DT5 and DT6 and dials DL1 can be prohibited.

Setting

1 When the (-) button is pressed for about 1 second at the initial screen, a confirmation beep is generated and the trim/dial lock display mark appears on the screen.

Clearing

1 Edit button lock and trim/dial lock can be cleared in the initial screen state by the same method as the setting described above. (The trim/dial lock display disappears from the screen.)

Total Timer

The total timer shows the accumulated time from last reset.

The total time does not change even when the model changes.

Reset method

1 In the initial screen state, hold down the (+) and (-) buttons simultaneously for 1 second.

* The total timer display counts up from 1 minute to 99hours 59 minutes.

Changing Wheel Position And Modifying For Left-hand Use

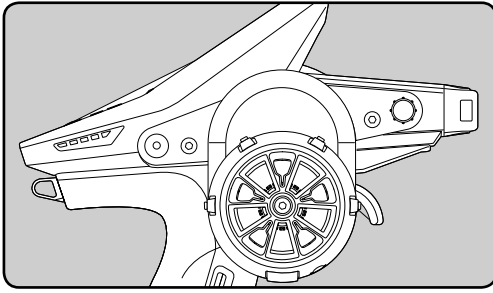

Changing the wheel position

The wheel position can be offset by using the accessory APA wheel position offset adapter.

(See page 23 for the modification method.)

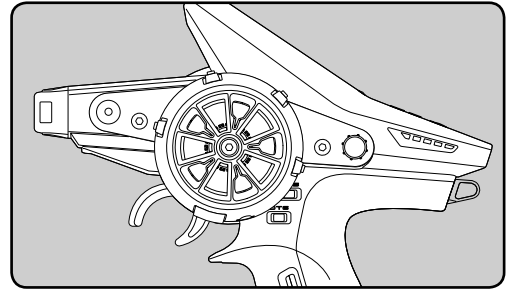

Modifying for left-hand use

The wheel section left and right installation direction can be reversed.

(See page 25 for the modification method.)

Before Using

Angle can be adjusted

The angle can be finely adjusted by adjusting the steering wheel unit installation. (See the modification method on the next page for the adjustment details.)

The operating angle of the wheel can be adjusted

The operating angle of the wheel can be changed from 34 deg to 32 deg by installing the 32 deg wheel adjuster. (See "Exchange procedure to wheel adaptor 32 deg" below for the replacement procedure.)

If you install the 32 deg wheel adapter, be sure to adjust the scale of the steering channel accordingly by using the "Adjuster Function" (p.152).

Exchange procedure to wheel adaptor 32 deg

- Obtain 2.5mm hex wrenchs./ Remove the battery.

1 Hold the wheel and remove the screw.

(Using a 2.5 mm hex wrench.)

Steering wheel mounting screw

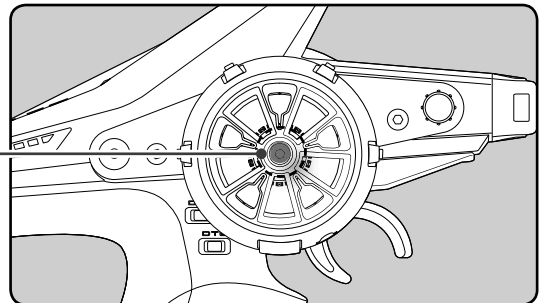

2 Pull off the wheel and wheel adapter.

3 Install the steering wheel and the 32 deg wheel adapter using the screw.

(Using a 2.5 mm hex wrench.)

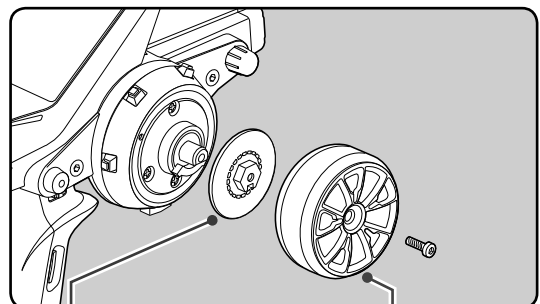

Wheel adapter

Wheel

Installing the accessory APA steering wheel offset adapter

- Obtain 2.5mm hex wrenchs./ Remove the battery.
- The length of the screws used at each part differs. When reassembling the steering wheel unit, always use the specified screws.

1 Remove the 2 steering wheel unit mounting screws.

(Using a 2.5 mm hex wrench.)

Remove the 2 mounting screws completely from the transmitter body.

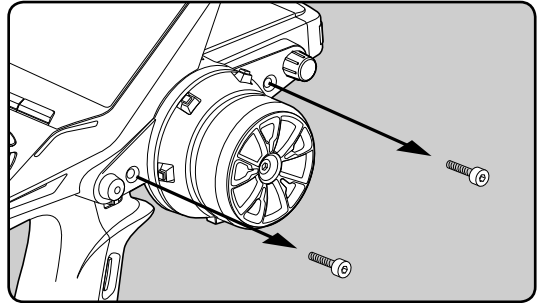

2 Being careful that the wiring is not too tight remove the steering unit.

- Remove the steering unit slowly so that the internal wiring is not pulled unreasonably.
- Removal is easy if performed in A→B order.

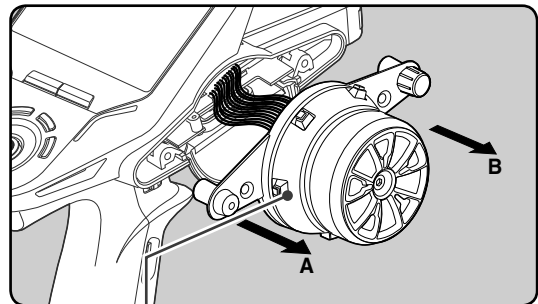

Steering wheel unit

3 Remove the 3 connectors from the PC board.

Remember the direction of the connectors.

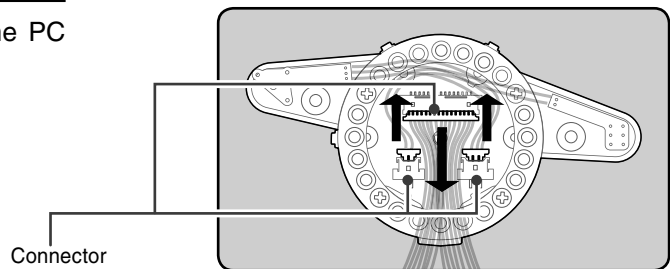

4 Using a Phillips screwdriver, remove the 4 screws (2.5x15mm tapping screw) mounting the wheel unit and switch unit.

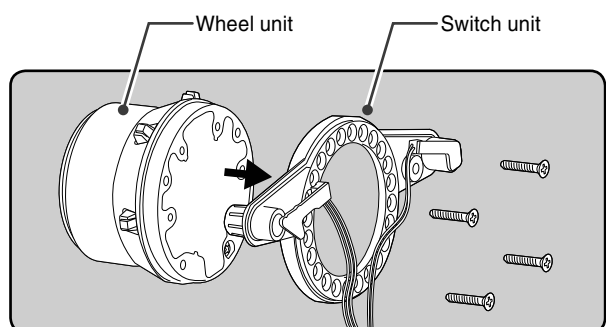
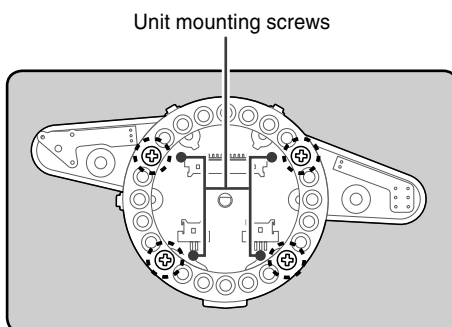

- 5** Pass the wiring from the transmitter and the charge unit wiring through the hole in the APA as shown in the figure and insert the 3 connectors at their original positions on the wheel unit PC board.

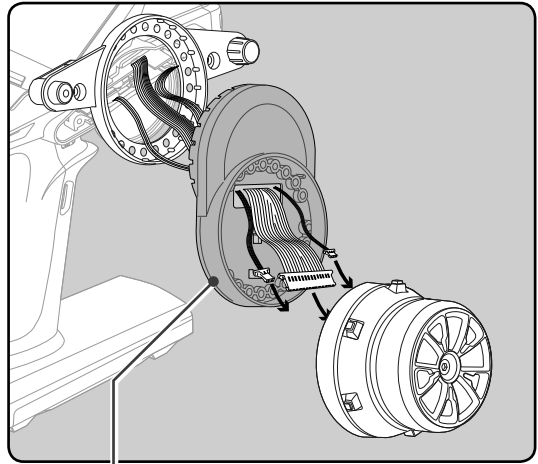
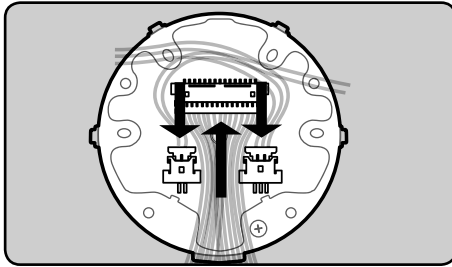

Adapter APA

- 6** Using a Phillips screwdriver fasten the wheel unit and APA at the desired angle using the 2.5x19 tapping screws in the accessory bag. Be careful that the screw length is correct. Be careful that the wiring does not get pinched. The angle can be adjusted, but check the marking point on the wheel unit and install the screws.

Screws can be installed at 4 places, but installation at 4 places may be impossible due to the wheel unit mounting angle.

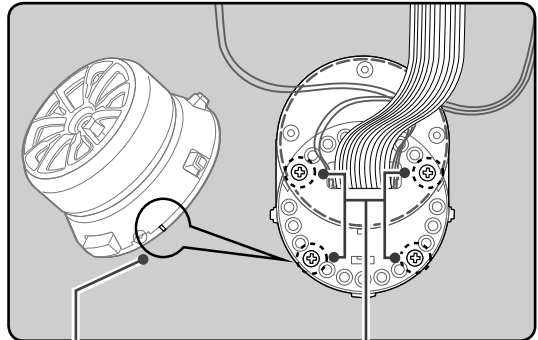

Marking

Wheel unit and APA mounting screws (2.5x19mm tapping screws)

- 7** Using a Phillips screwdriver fasten the switch unit and APA. Use the 2.5x10mm tapping screws in the accessories bag. Next, install the APA rear cover. Be careful that the length of the screws is correct.

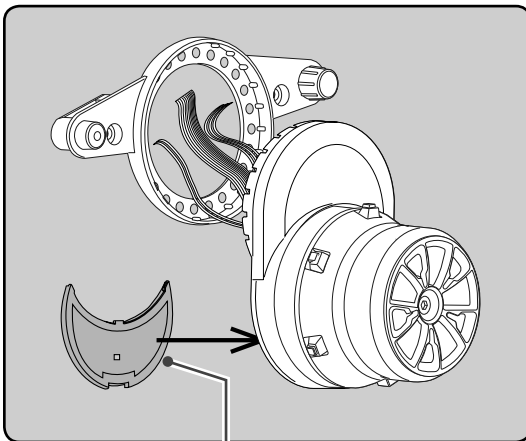

APA rear cover

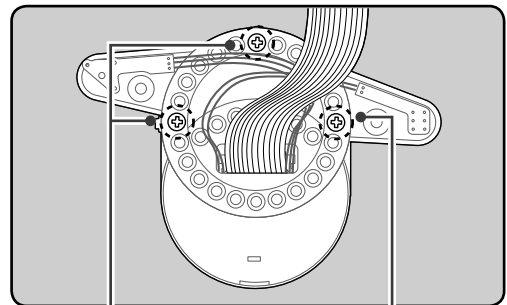

Switch unit and APA mounting screws (2.5x10mm tapping screws)

8 Install the assembled steering unit to the transmitter body.

Install slowly so that the wiring is not pinched.
Installation is easy if inserted in A→B order.

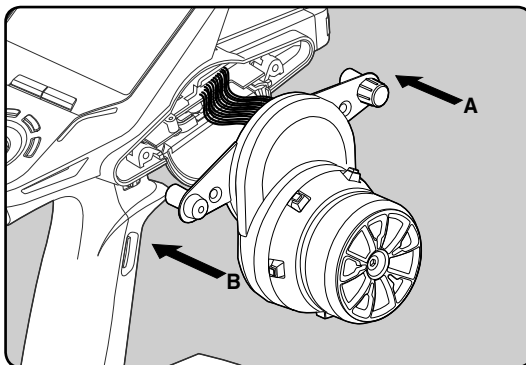

9 Install the assembled steering wheel unit and APA to the transmitter using the screw (3.0x12mm cap screw) supplied. (Using a 2.5 mm hex wrench.)

Steering wheel unit mounting screws

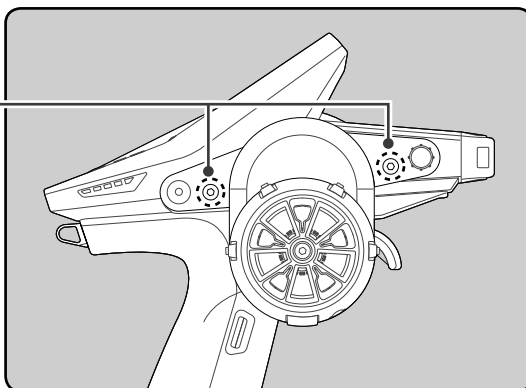

Modifying for left-hand use

- Obtain 2.5mm hex wrenches.
- Refer to 1-2 (P24) of the APA for the wheel position change installation method and remove the wheel unit. Only remove the 15WIRE connector. (See p.26)

1 Slowly pull out the PS5 switch cap and mounting plate in the arrow direction.

Be careful that the switch body does not get caught and damaged.

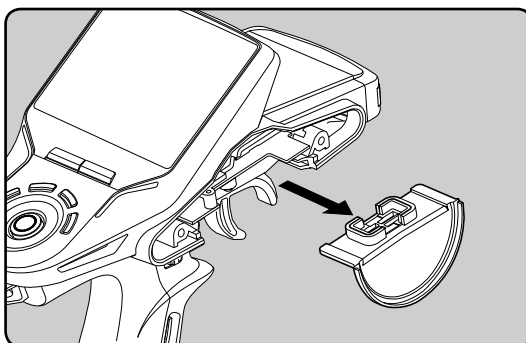

2 Next, remove the opposite side charge unit. Refer to the figure and secure the arrow part with tape, etc.

The tape is removed at the end of left-hand modification.

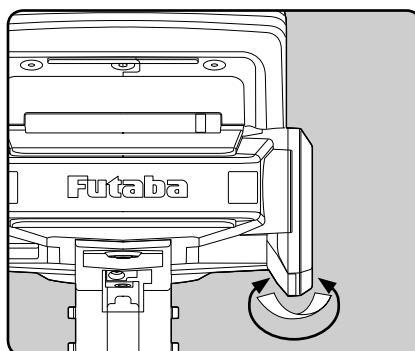

- 3** Using a 2.5mm hex wrench, remove the mounting screws (3.0x1.2mm cap) of the opposite side charge unit.
Remove the 2 mounting screws completely from the transmitter body.

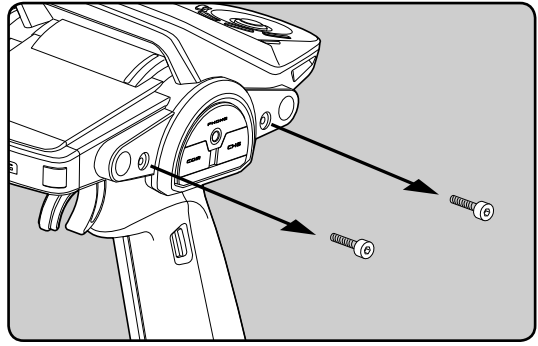

- 4** Being careful that the wiring is not too tight slowly remove the charge unit. Remove the connector from the PC board.
Remember the direction of the connector.

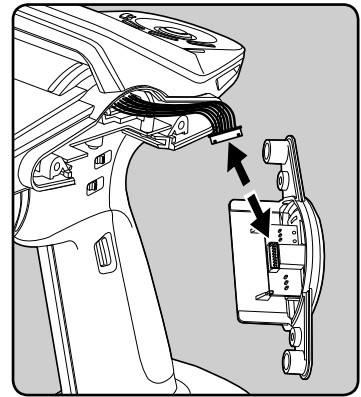
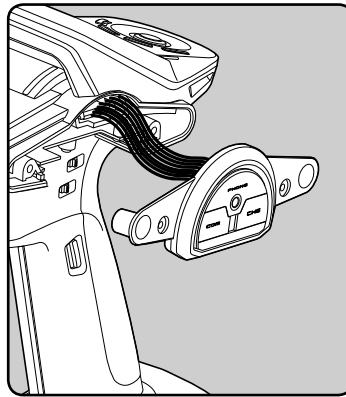
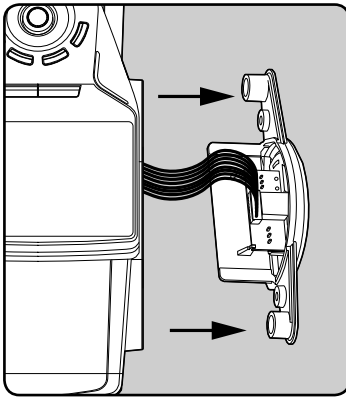

- 5** Interchange the 15WIRE wiring connector of the steering unit and the 8WIRE wiring connector of the charge unit, while being careful that the wiring is not too tight.

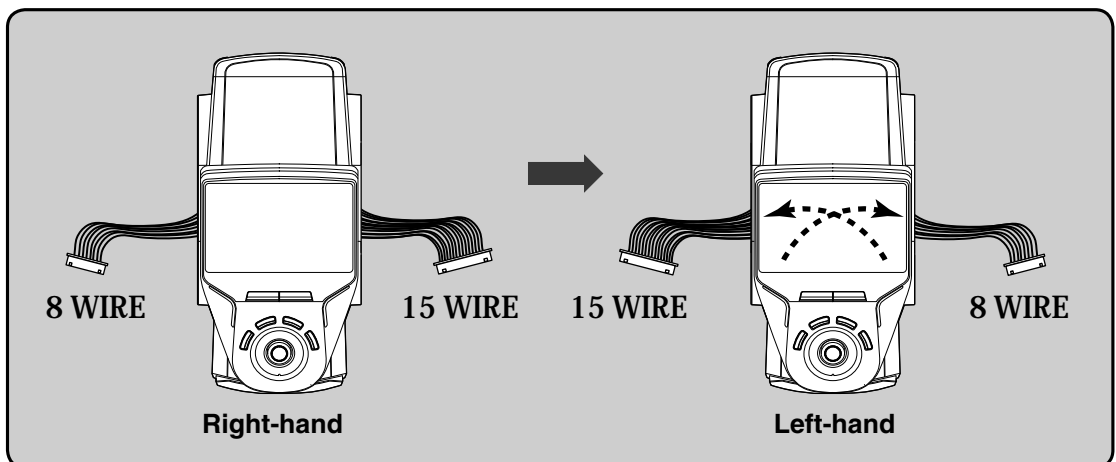

6 Insert the 8WIRE wiring connector onto the charge unit connector, and install the charge unit and transmitter body with the mounting screws.

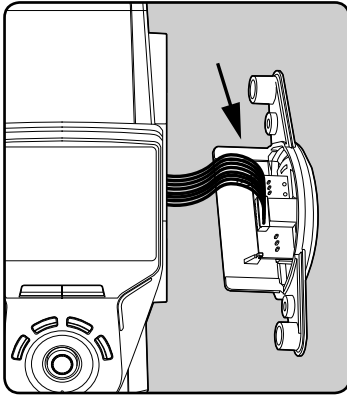

Charge unit mounting screws

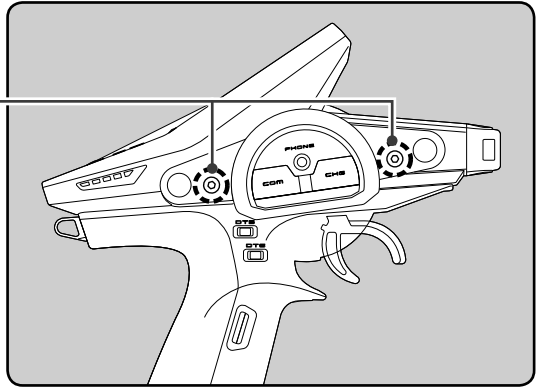

7 Install the PS5 switch cap and mounting plate removed at step 1 at the opposite side of the transmitter body.
Be careful that the switch body does not get caught and damaged.

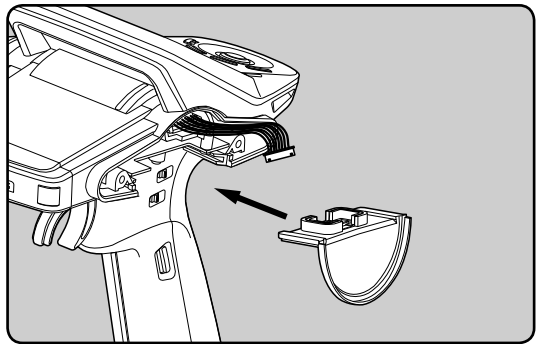

8 Insert the 15WIRE wiring connector onto the steering unit, and install the steering unit to the transmitter body.

Install slowly so that the wiring does not get pinched.
Installation is easy when inserted in A→B order. (Figure at the right)

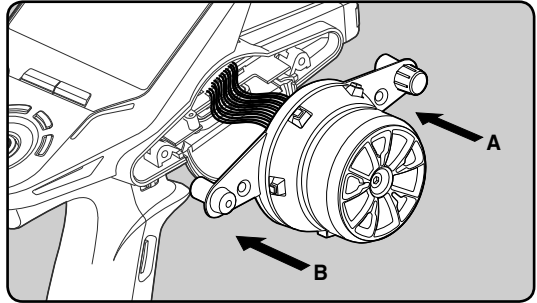
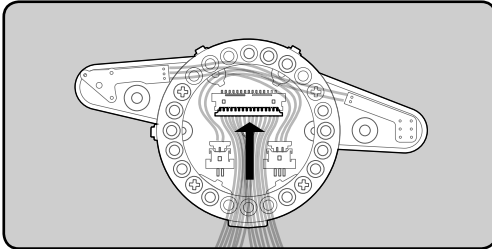

9 Install the assembled steering wheel unit and APA to the transmitter using the screw (3.0x12mm cap screw) supplied.
(Using a 2.5 mm hex wrench.)

Peel the tape installed at step 2.

Steering wheel unit mounting screws

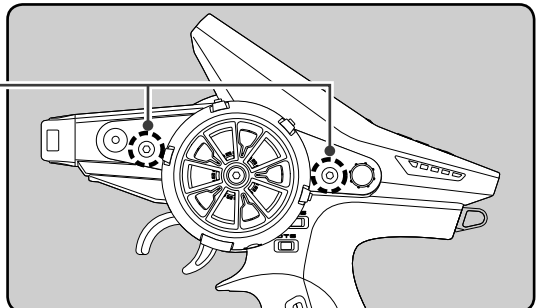

Using the optional angle spacer

The wheel mounting angle can be changed by using the optional angle spacer.

Three 2.5x10mm tapping screws are supplied with the angle spacer.

When using and not using the APA, refer to the following installation.

Obtain a Phillips screwdriver. Be careful of the length of the screws used.

Actually, since there is wiring, the wheel is assembled by passing the screws through each part.

Before Using

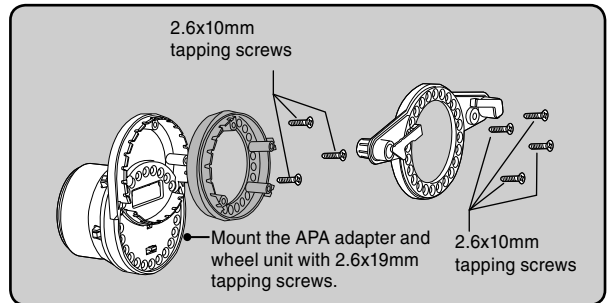
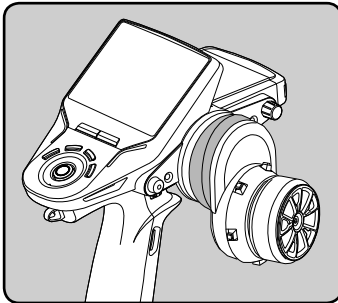
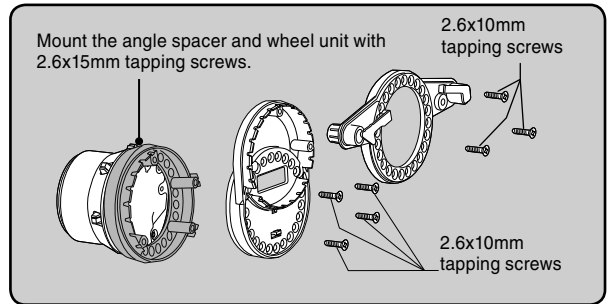
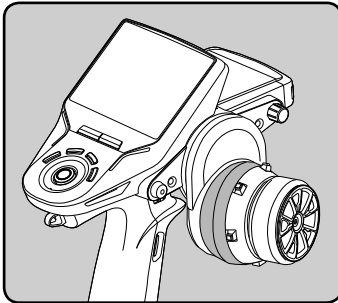
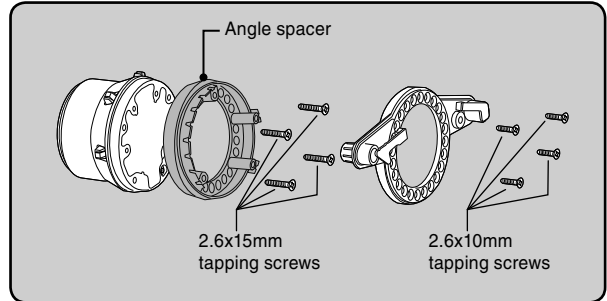
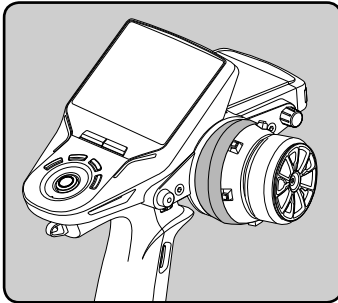

Trigger brake lever replacement

The trigger brake lever is selected from a narrow nylon type and wide type. (Narrow type is installed at the factory.)

*When the brake lever was changed, perform throttle side correction by adjuster function (P152).

Brake lever replacement

Obtain a 1.5mm hex wrench. Remove the battery from the transmitter.

- 1 Hold the trigger, remove the brake lever mounting screw using the 1.5mm hex wrench, and remove the brake lever.
- 2 Using the 1.5mm hex wrench install the wide type brake lever with the brake lever mounting screw.

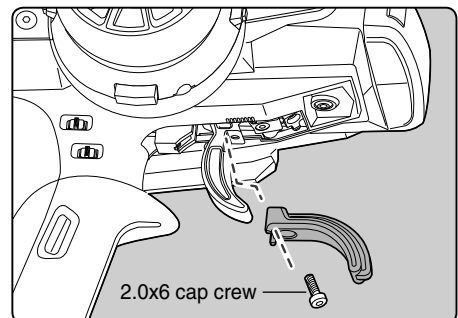

Non-telemetry LED (telemetry OFF sign)

When the telemetry function is inhibited by race regulations, a special LED lights when the telemetry function is OFF to confirm that the telemetry function is not operating.

Non-telemetry LED
(Lit when telemetry function is OFF)

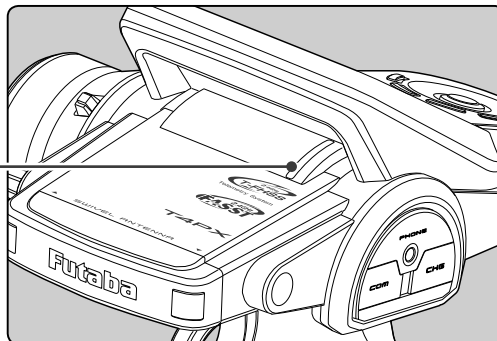

Handling the antenna and card slot and receiver

About T4PX Antenna

Cannot rotate more than 90°. If rotated forcibly, the antenna will be damaged.

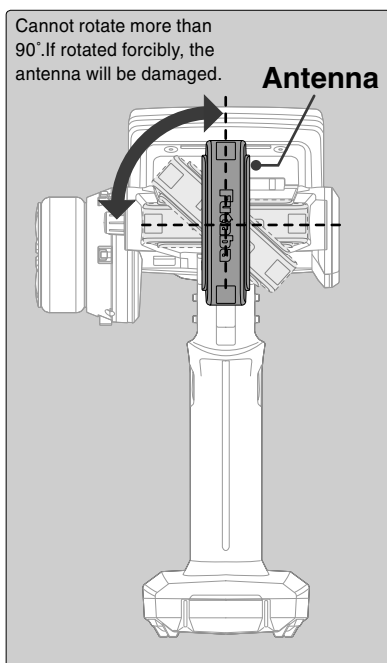

Antenna Moving Range

If the antenna is set to the 90° vertical position, the range of the radio waves may be greater than in the horizontal position. (Different depending on the conditions)

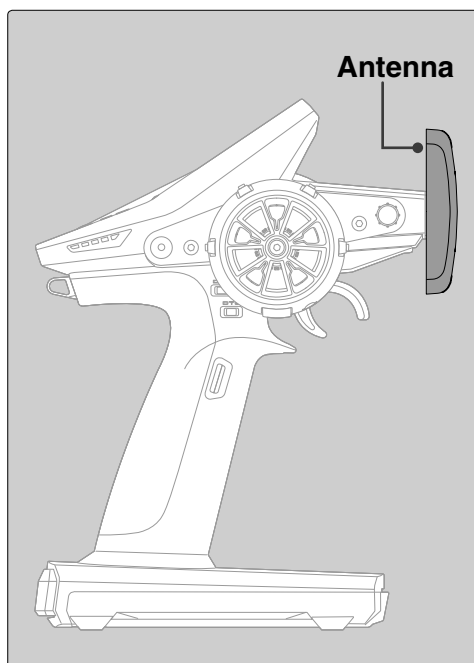

Before Using

⚠ Caution

⊗ Please do not grasp the transmitter's antenna during drive.

Doing so may degrade the quality of the RF transmission to the model.

⊗ The antenna position can be changed in the range as shown in figure. However, please do not apply unnecessary force or shock.

The internal cable may be damaged; thus transmitting distance decreases and it may cause malfunction.

There might be a small glitch when the antenna of the transmitter is brought close to servos, ESCs or other peripheral devices.

This is not an issue but please keep this symptom in mind, especially when setting-up.

Handling an microSD card (commercial product)

T4PX model data and telemetry log data can be saved by using a commercial microSD card. When T4PX software updates are released, the microSD card can also be used to make the update.

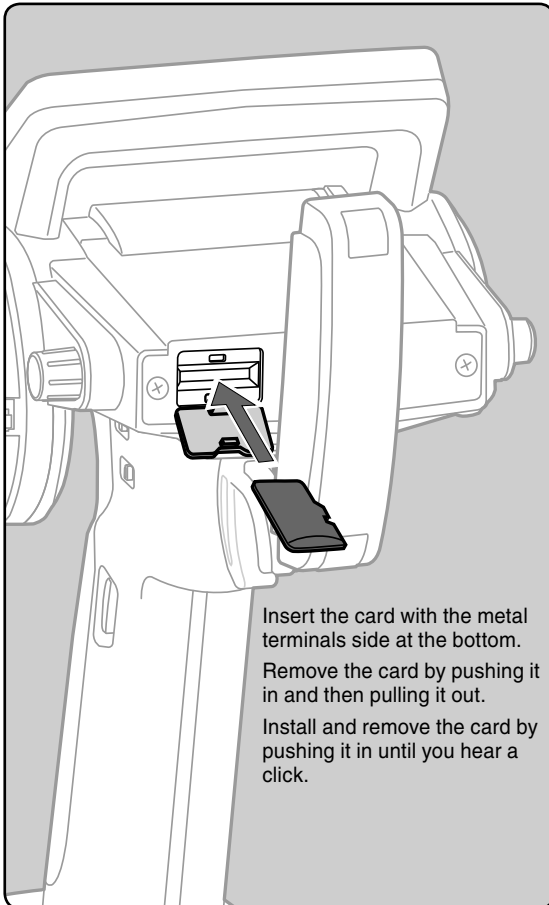

(Commercial product)



SD standard and SDHC standard microSD cards

(Some models may not be operated by card.)

*The data in the memory card cannot be guaranteed regardless of the contents and cause of trouble or damage. Always back-up the valuable data in the memory card.

⚠ Caution

❶ Always insert and remove the microSD card in the state in which the transmitter power is off.

If the microSD card is removed while being accessed (read or write), the card itself and the data may be destroyed.

❷ Do not install and remove the microSD card with the microSD card slot facing your face.

If you remove your fingers quickly, the microSD card may fly out and strike your face and is dangerous.

⊘ Since the microSD card is a precision device, do not subject it to unreasonable force or shock.

-When a microSD card is installed in the T4PX transmitter, a folder called "Futaba" is created. Folders called "LOG" and "MODEL" are created in this folder. The "MODEL" folder stores the model data and the "LOG" folder stores the telemetry log data. When "Save screen" is set at the push switch by switch setting, an image of the screen to be displayed on the T4PX is saved by that switch. The saved image is stored in a folder call "PICTURE". A "PICTURE" folder is not created until "Save screen" is set.

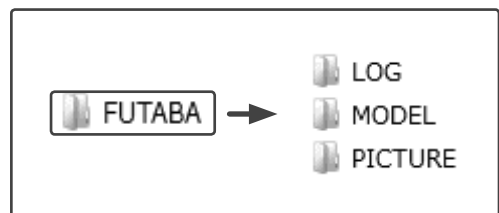

-The telemetry log data recorded on the microSD card can be converted to CSV format by the telemeter log converter released on our home page. When copying or moving a log file, always select both .FLI and .FLD file.

Receiver Terminology

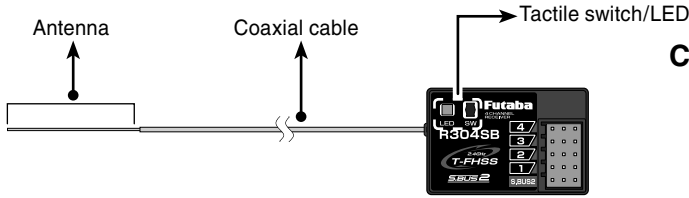

Connectors

- 4 :CH4 servo(CH4)
- 3 :CH3 servo(CH3)
- 2 :Throttle servo(CH2)
- 1 :Steering servo(CH1)
- S.BUS2:Power /S.BUS2 connector

The receiver power supply can be connected to the S-BUS2 connector or each of CH1-4.

Receiver Installation

Install the R304SB receiver on the car as follows:

The operating range may become shorter, depending on where the receiver and the antenna are mounted.

⚠ WARNING

- ⊙ Do not cut or bundle the receiver antenna wire.
- ⊙ Do not bend the coaxial cable. It causes damage.
- ❶ Install the antenna in the higher place as shown in the figure.
- ❶ Put the antenna in the antenna tube to protect it.
- ❶ Keep the antenna as far away from the motor, ESC and other noise sources as you possibly can.
- ❶ Wrap the receiver with something soft, such as foam rubber, to avoid vibration. If there is a chance of getting wet, put the receiver in a water-proof bag or balloon.
- ❶ The antenna is installed under the plate (top) of the R304SB-E receiver. Do not place wiring or other objects on the plate. The receiving range may be affected.

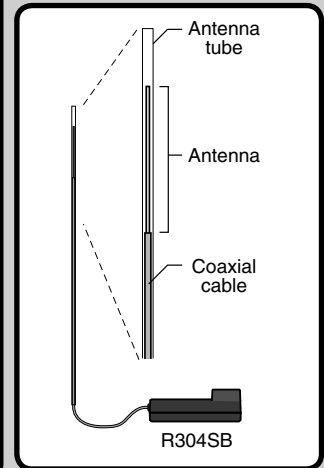

⚠ Caution

- ❶ Always use R304SB/R304SB-E under the following conditions:
 - Battery :Power requirement Rated voltage 4.8~7.4V (dry cell battery cannot be used) / 3.5 to 8.4V useable
Matched to the ratings of the receiver and connected servo.

- Transmitter's receiver type : "T-FHSS"
- Transmitter's receiver type: Digital servo type : Futaba digital servo
- Transmitter's receiver type: Analog servo type : Futaba all servo

Under other conditions, the set will not operate, or the specified performance will not be displayed even if it operates. In addition, it may cause trouble with servos and other equipment. Futaba will not be responsible for damage, etc. caused by combination with the products of other companies.

Transmitter mode setting

Set the transmitter to the "T-FHSS" mode. See page 36 for a description of the setting method.

Note: However, digital servos (including BLS Series brushless servo) can only be used in the "Digital servo type".

Receiver And Servo Connections

Connect the receiver and servos as shown below. Connect and install the receiver and servos in accordance with "Installation Safety Precautions" on the next page.

The figure shown below is an example. The method of connecting the motor controller to the motor and battery depends on the motor controller used. Purchase the motor controller and servos separately. The receiver also depends on the set.

When using the DSC cord with a gasoline engine car, connect the optional double extension cord to B/C of the receiver and the DSC cord and receiver switch to the opposite side connector.

Installation When An Electronic Speed Control Is Used

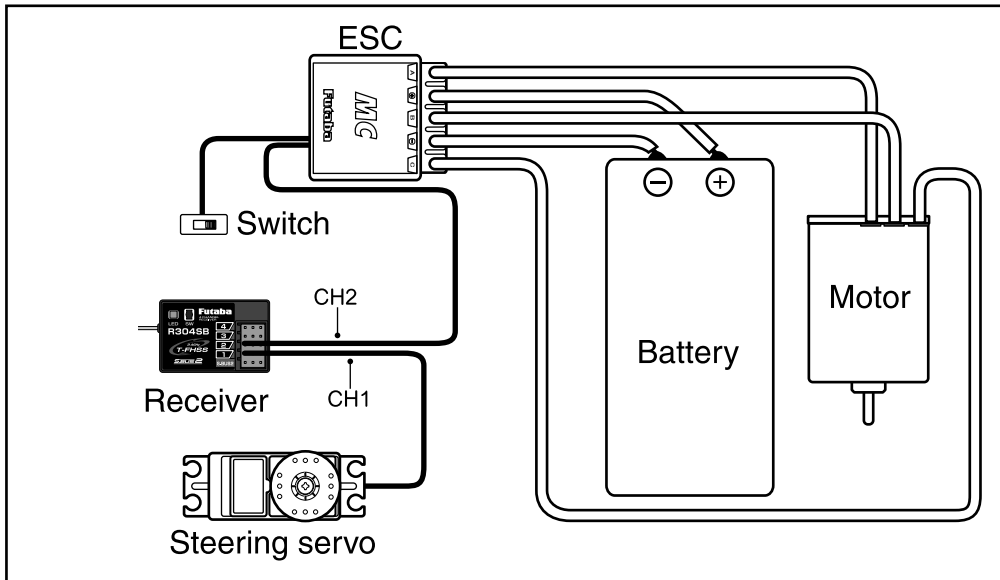

Installation For Gas Powered Models

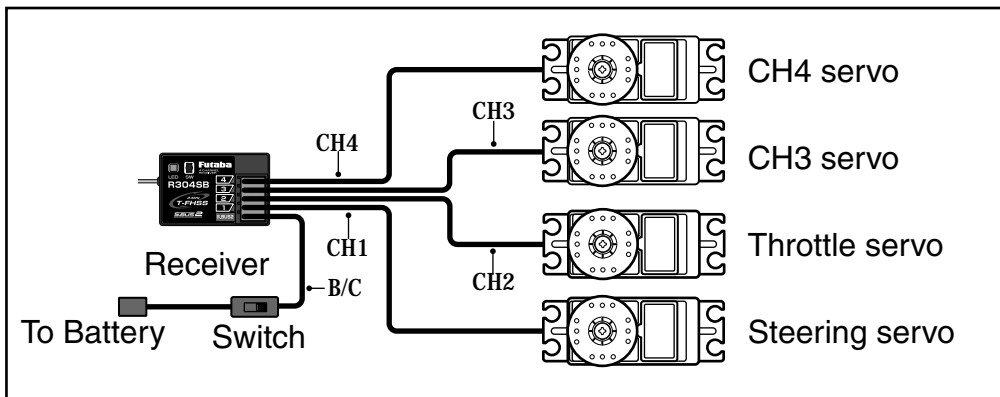

Installation Safety Precautions

⚠ Warning

Receiver (receiver antenna)

- ⊗ Do not cut or bundle the receiver antenna wire.
- ⊗ Do not bundle the receiver antenna wire together with the motor controller lead wire.
- ⊗ Keep the receiver antenna wire at least 1cm away from motor, battery, and other wiring carrying heavy current.
- ⊗ Do not use a metal receiver antenna holder on a plate made of metal, carbon, or other conductive material.
- ❶ Install the receiver antenna holder as closely as possible to the receiver.

If the antenna wire is cut, bundled, or routed near a noise source, the receiving sensitivity will drop, the running (cruising) range will decrease, and you may lose control of the model.

*Noise is transmitted through metal, carbon, and other conductive material, so keep the receiver antenna wire away from such parts.

Antenna

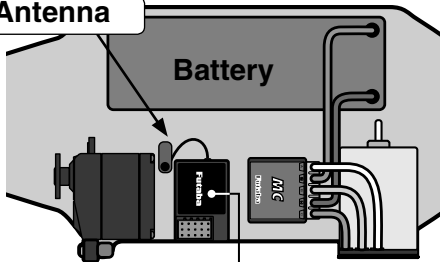

Install the receiver as far away as possible from the battery, motor controller, motor, silicon cord and other noise sources. Keep it away from the antenna wire, in particular.

Since the antenna of built-in antenna receivers is installed under this, do not place wiring or other objects on it.

Receiver Vibration-proofing / Waterproofing

(Car)

- ❶ Vibration-proof the receiver by wrapping it in foam rubber or other vibration-absorbing material and mount it with thick double-sided tape.
- ❶ When using the receiver holder supplied with the model kit, mount the holder to the chassis through a rubber grommet.

(Boat)

- ❶ Vibration-proof the receiver by wrapping it in foam rubber or other vibration-absorbing material. Also waterproof the receiver by crusing it in a plastic bag.

If the receiver is exposed to strong vibration and shock, it will operate erroneously due to the invasion of water drops and you may lose control of the model.

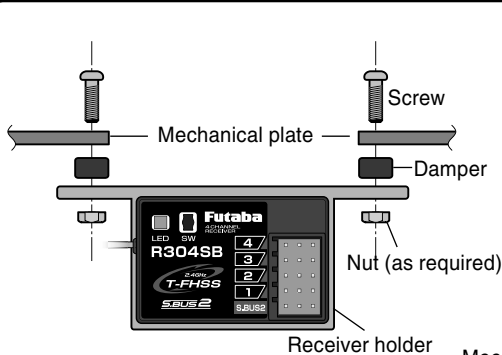

When using the receiver holder supplied with the kit, install the receiver through a rubber grommet.

Foam rubber, etc.



Wrap the receiver in foam rubber or other vibration-absorbing material. Do not use hard material. Hard material does not have a vibration-proofing effect.

Mechanical plate



When mounting the receiver with double-sided tape, do not use a stiff tape. Stiff tape does not have a vibration-proofing effect.

Warning

Connector Connections

- 1 Be sure the receiver, servo, battery and connectors are fully and firmly connected.

If vibration from the model causes a connector to work loose while the model is in operation, you may lose control.

Servo Installation

- 1 When you install the servos, always use the rubber grommets provided in servo hardware bags. Mount the servos so they do not directly come in contact with the mount.

If the servo case comes in direct contact with the mount, vibration will be directly transmitted to the servo.

If this condition continues for a long time, the servo may be damaged and control will be lost.

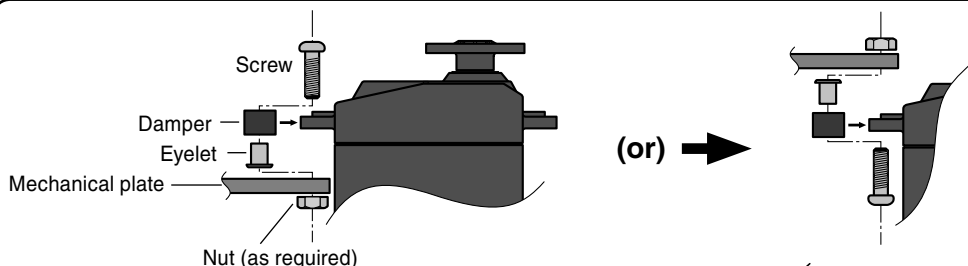

When installing the servo, always install the accessory rubber grommet and grommet flush against the servo.

A vibration-damping effect is not obtained even if the rubber grommet and grommet are not installed correctly.

Servo Throw

- 1 Operate each servo over its full stroke and be sure the linkage does not bind or is loose.

The continuous application of unreasonable force to a servo may cause damage and excessive battery drain.

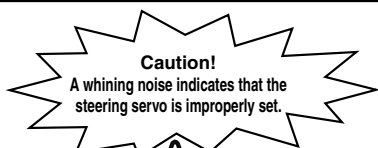

Decide the EPA value at the contact point.

Adjust the steering servo so that unreasonable force is not applied to the servo by the chassis at maximum servo travel.

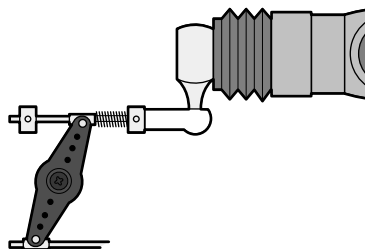

Adjust the throttle servo so that unreasonable force is not applied when the engine carburetor is fully open, fully closed, and the brakes are applied fully.

If the brakes overheat while running, their ability to function properly decreases. Before running, adjust the suitable maximum servo travel so that unreasonable force is not applied even when the servo travel is increased while running.

Warning

Electronic Speed Cont

- ❶ Install the heat sinks where they will not come in contact with aluminum, carbon fiber or other parts that conduct electricity.

If the FET Amp (Electronic speed control) heat sinks touch other materials that conduct electricity a short circuit could occur. This could result in loss of control and damage to the system.

Motor Noise Suppression

- ❶ Always install capacitors to suppress noise when electric motors are used.

If capacitors are not properly installed you could experience erratic operation and reduced range as well as loss of control.

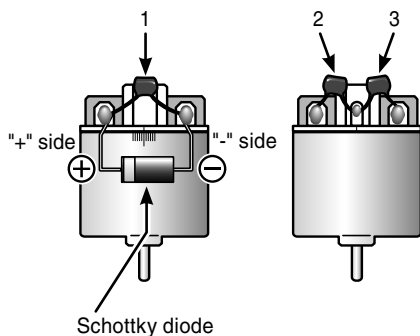

Motors with no suppressor capacitors, or inadequate suppression, may cause the receiver to malfunction. Always solder the capacitors supplied to your motor.

The Schottky diode improves the efficiency of the speed control / motor combination and provides extra protection to the brake FETs. The white ring must always face the positive side.

Other Noise Suppression Methods

- ❶ Be sure there are no metal parts in your model which under vibration can come in contact with other metal parts.

Metal to metal contacts under vibration will emit a high frequency noise that will affect the receiver's performance. You could experience erratic operation and reduced range as well as loss of control.

Preparations (Transmitter)

(Display when power switch turned on)

When the power switch is turned on, the currently selected model number is displayed. Check if this number is the model number you want to set-up. To change the model number, use the Model Select function. (p.112)

Turn on the transmitter power.

The model number is displayed.

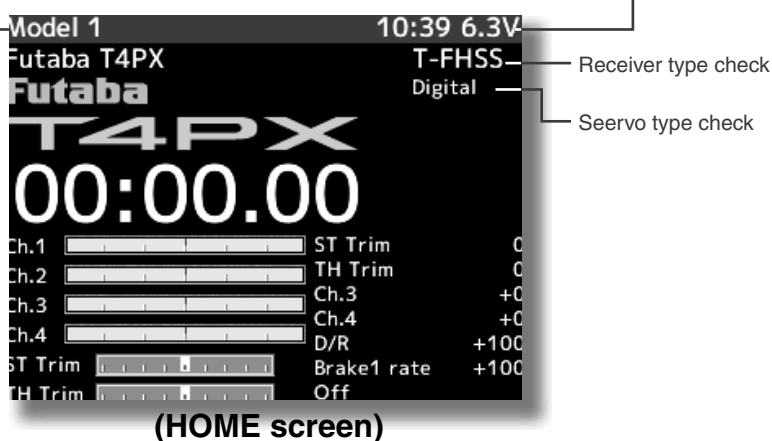

Before setting up each function of the transmitter, check and set the following items.

RF Output & Rx Type Check

Check if the receiver type is set to the type of receiver used.

*When the "PWR" side power switch is set to ON and radio waves are output normally, "T-FHSS", "S-FHSS", or "FASST" is displayed. If not displayed, there is probably an abnormality or trouble so contact a Futaba Service Center.

When a screen is displayed at the "DSP" side, "Display" is displayed.

*Since the R304SB receiver supplied with the T4PX set uses the telemetry function T-FHSS system, T4PX receiver setup must be set to T-FHSS.

The R2104GF and other S-FHSS and FASST system receivers, as well as the R304SB T-FHSS system receiver can be used with the T4PX transmitter. However, only R614FS/FS/FF-E and R604FS/FS-E "C2" type receivers can be used with the FASST system.

The R603FS/FF "C1" type cannot be used.



Receiver Type Change & How To Link

First set up the receiver. Setting changes are immediately reflected. Next, the transmitter and receiver are linked and the receiver memorizes the transmitter ID number so that signals from other transmitters will not be received.

In addition, with the T-FHSS telemetry system, the transmitter simultaneously memorizes the receiver ID numbers so that data from other receivers will not be received.

The method of setting up the receiver type and the method of linking the transmitter and receiver are described. Refer to the figure at the right for the edit buttons used.

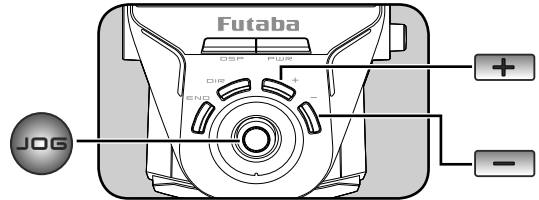

- 1 Set the transmitter "PWR" side power switch to ON.

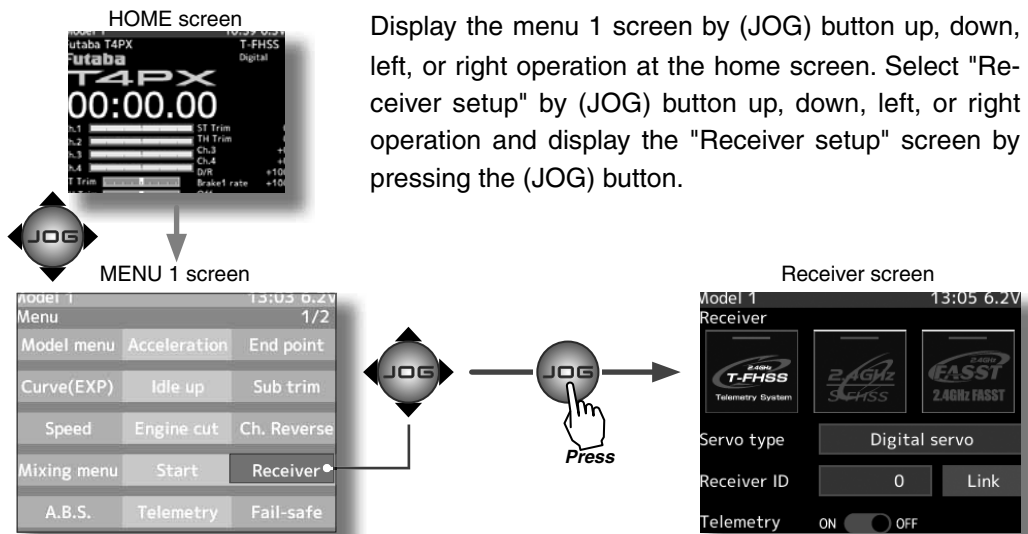

- 2 Select the receiver type to be changed by (JOG) button left or right operation. When the (JOG) button is pressed, a confirmation screen is displayed. To execute the change, select "YES" by JOG button. When the JOG button is pressed for about 1 second, an electronic beeping sound is generated and setting is ended. To cancel the change, select "No" and press the (JOG) button.

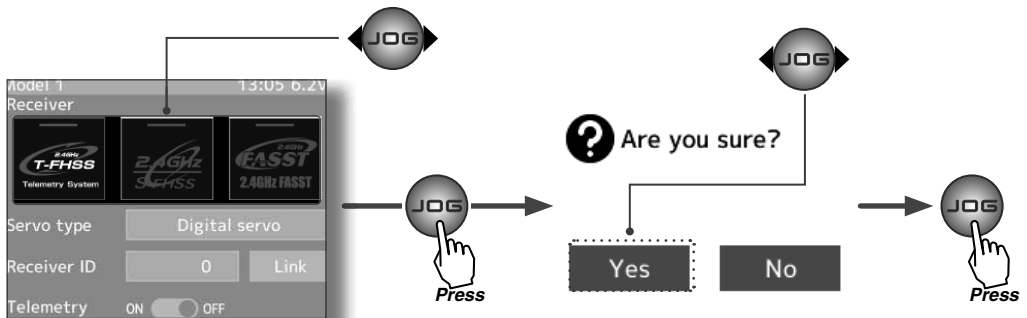

- * After set up this far is complete, when using a FASST system (R614FS/FF/FF-E) or S-FHSS system (R2104GF, R204GF-E, etc.) receiver, go to "Receiver other than T-FHSS" on P39. When using a telemetry function T-FHSS receiver (R304SB, etc.), go to step

- 3** Bring the transmitter and receiver within 50cm of each other (antennas do not touch) and turn on the receiver power.
- 4** Move the cursor to "Link" by T4PX transmitter (JOG) button up or down operation. When the (JOG) button is pressed, a chime will sound and the T4PX will enter the link mode for 20 seconds. During this 20 seconds link mode, press the receiver tactile switch for at least 2 seconds.

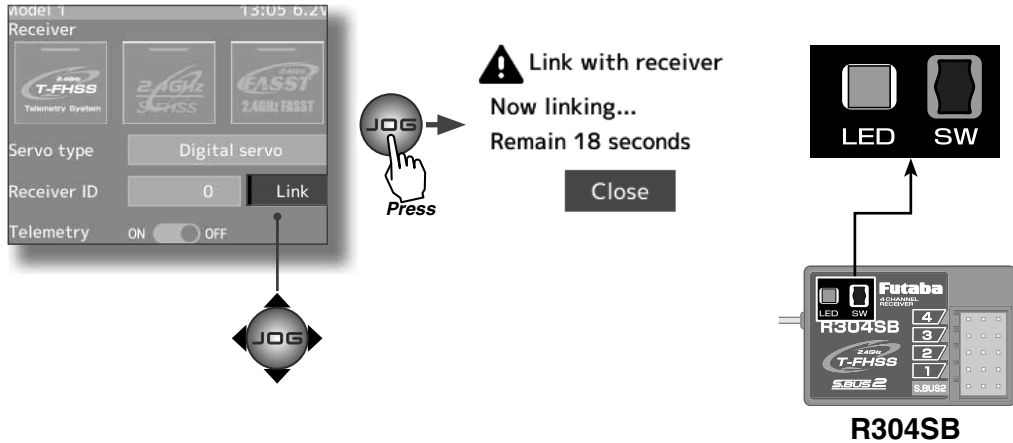

- 5** During the 20 seconds link mode, press the receiver tactile switch for at least 2 seconds. The LED blinks red and then changes to a greenish red → green steady light. When the T4PX makes a beeping sound and the message "Link with receiver" appears on the screen, release the receiver tactile switch. This ends reading of mutual ID and displays the memorized receiver ID number on the T4PX screen. If the "Receiver not found" error screen is displayed, linking failed. Check the set contents and repeat the linking operation.

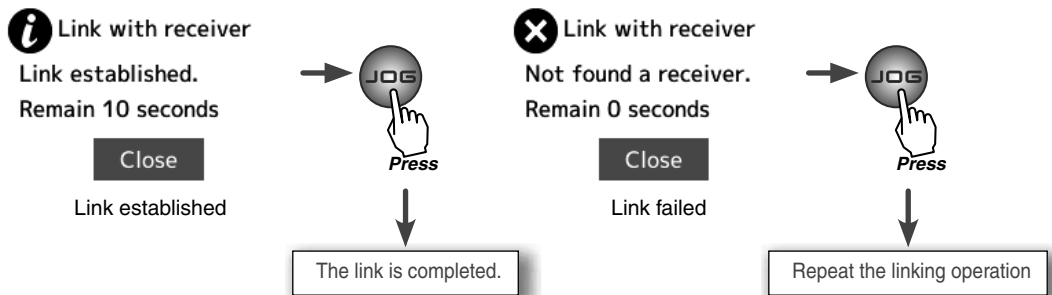

- * The T4PX and a telemetry system T-FHSS receiver (R304SB, etc.) memorize the IDs linked last at each model memory. Since only one receiver ID is memorized at each model memory, multiple T-FHSS receivers cannot be used with the same model memory. When a receiver at the same model memory is changed, re-linking is necessary even if the receiver is already linked with the transmitter.

When using multiple T-FHSS telemetry receivers, link each receiver with each T4PX model memory. However, one receiver can be linked with multiple model memories. The telemetry function communication status can be checked at the T4PX home screen.

Receivers Other Than T-FHSS

- 1 Bring the transmitter and the receiver close to each other, within 20 inches (half meter).

- 2 Turn on the transmitter.

- 3 Turn on the receiver.

- 4 Push the tactile switch of the receiver.
When the link is complete, the LED in the receiver changes to solid green.

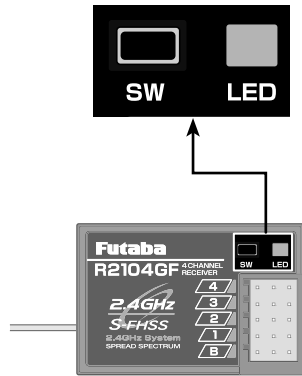

Precaution:

If there are many Futaba 2.4GHz systems (T-FHSS/ S-FHSS/ FHSS) turned on in close proximity to your receiver might not link to your transmitter. In this case, even if the receiver's LED stays solid green, unfortunately the receiver might have established a link to one of other transmitters. This is very dangerous if you do not notice this situation. In order to avoid the problem, we strongly recommend you to double-check whether your receiver is really under control by your transmitter by giving the stick input and then checking the servo response.

*Please refer to the table below for LED status vs receiver's condition.

LED status vs receiver's condition:

No signal reception	Red : On
Receiving signals	Green: On
Receiving signals, but ID is unmatched.	Green: Blink *1 (T-FHSS ,Red : On)
Unrecoverable failure (EEPROM,etc.)	LED: Red and Green turn on alternately

*1: LED could be change to red during intermittently during data processing.

Warning

- ❶ After the linking is done, please cycle receiver power and check if the receiver to be linked is really under the control of your transmitter.
- ❷ Do not perform the linking procedure with motor's main wire connected or the engine operating as it may result in serious injury.

Servo Type Check

Check if the servo type setting matches the servo used. When a digital servo (including BLS brushless servo) is used, "Digital servo" or "Analog servo" can be set. Since an analog servo cannot be used with the "Digital servo" setting, the servo type must be set to "Analog servo". If used with the wrong setting, the analog servo will be damaged. If the setting is incorrect, change it by the following method.

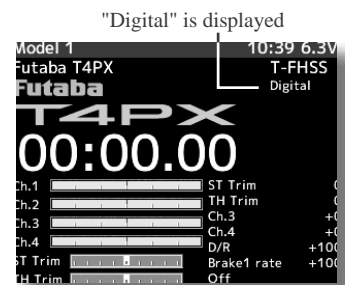

For "Digital servo" type

Refer to page 36 and display the "Receiver setup" screen. Move the cursor to the servo type by (JOG) button up or down operation. Changes when "Digital servo" or "Analog servo" is selected by pressing the (+) or (-) button.

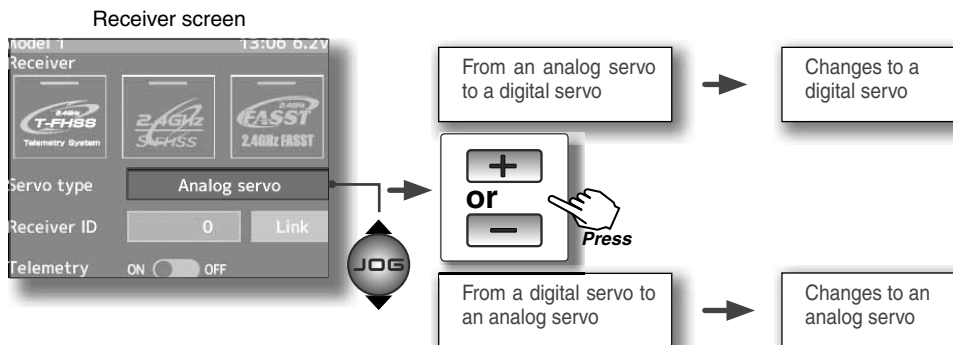

Trigger Ratio Check

-The throttle servo travel can be set to 50:50, 70:30 or 100:0 for throttle trigger operation as required by the Trigger mode function (p.66).

-The throttle brake operation might be a close by setting it to "100:0" when the T4PX transmitter with the boat is used.

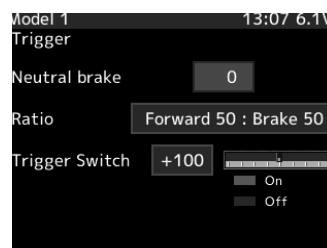

Trigger mode screen

Trims Initial Set-Up

- Steering trim (DT1) check

On the initial set-up, steering trim is assigned to the DT1 trim lever above. Operate the lever and make sure the marker moves on the ST graph. If default has been changed, test steering trim in its new location. After checking the trim, set the trim display to the center (N) position.

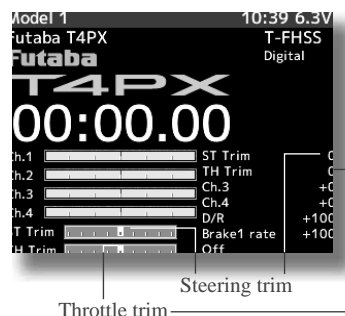

- Throttle trim (DT2) check

On the initial set-up, throttle trim is assigned to the DT2 trim lever. Operate the lever and make sure the marker moves on the TH graph. If the default has been changed, test the throttle trim in its new location. After checking the trim, set the trim display to the center (N) position.

Throttle trim (DT2) Steering trim (DT1)

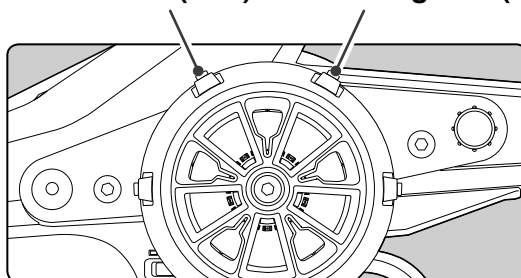

- Steering dual rate (DT5) check

At initial set-up, steering dual rate (D/R) is assigned to DT5 trim lever, at the grip of the transmitter. Operate the DT5 and check if the D/R value displayed on the screen changes. After checking D/R, set the steering dual rate to 100%.

- Brake rate (DT6) check

At initial setting, brake rate (Brake1 rate) is assigned to DT6 trim lever, below DT6. Operate the DT6 and check if the Brake1 rate value displayed on the screen changes. After checking Brake1 rate, set brake rate to 100%.

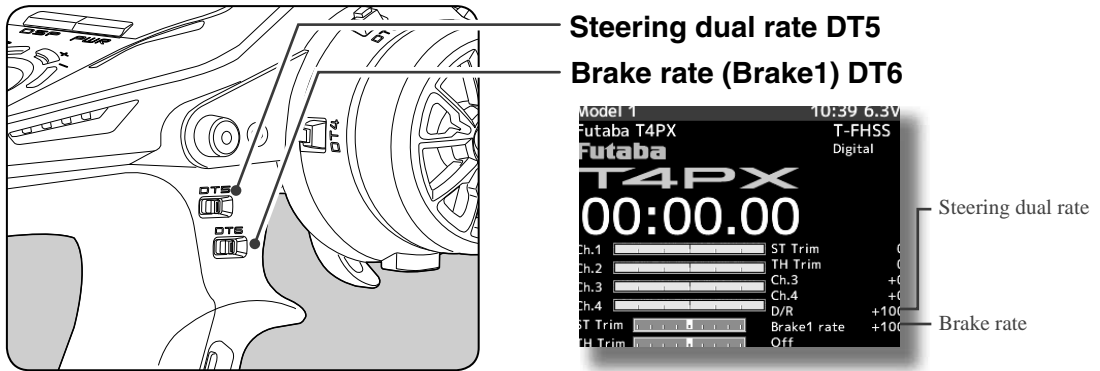

(Set-Up Procedure When Installed In a Car)

When installing the servos in a car, performing function set-up in the following order is recommended.

- 1** Initialize all the trims.
- 2** Set the servo direction of operation using the Reverse function. (p.47)
 - The servo installation method and linkage direction depend on the kit. Therefore, the servo operation direction may have to be reversed relative to transmitter operation. Before installing the servo, check the operating direction and set it using the Reverse function.
- 3** Set the subtrim and adjust the servo neutral point. (p.48)
- 4** Set the trigger travel by adjusting the throttle trigger mechanical ATL to your liking. (p.18)
 - When the stroke was adjusted, compensate the throttle by adjuster function (p.152).
- 5** Set EPA of each channel and adjust the servo throw (travel). (p.49)

Menu Selection

In this instruction manual, Edit Buttons are represented by the symbols shown below. The (JOG) button can be operated in the 4 directions up, down, left, and right.

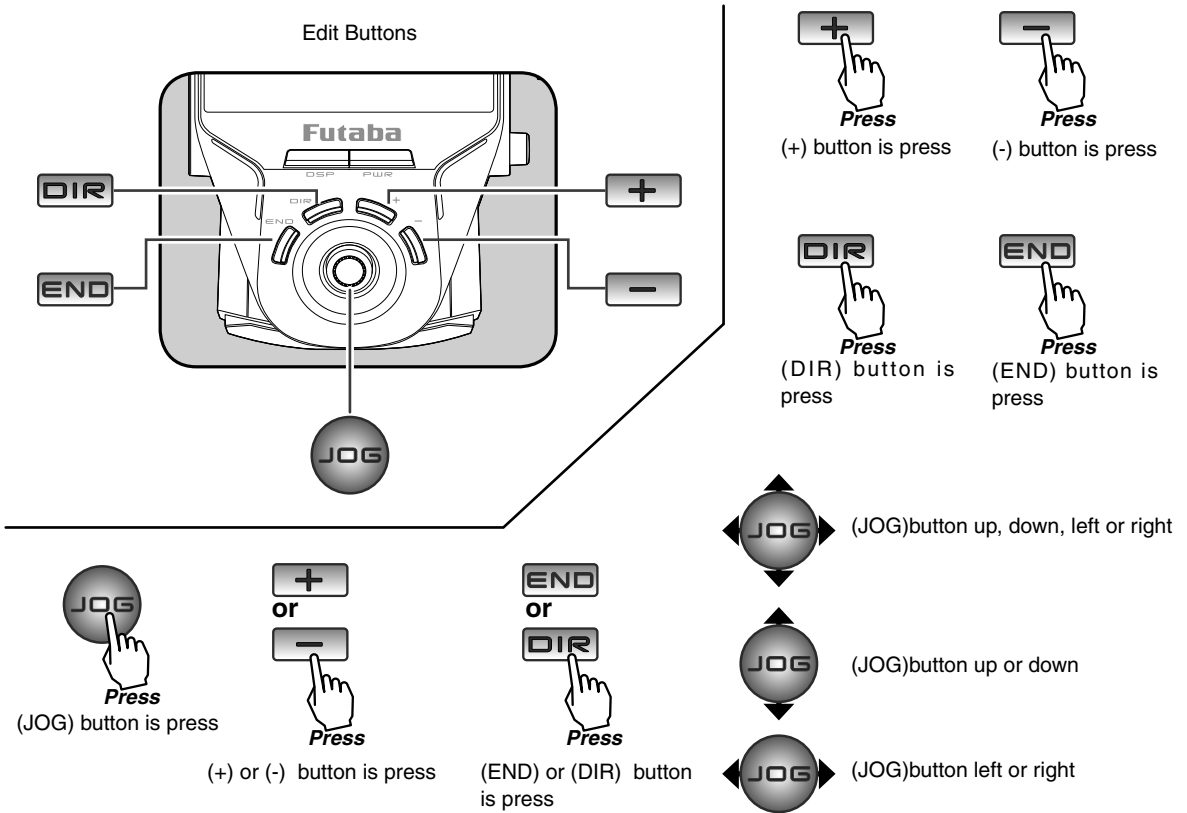

Calling The Menu Screen

The menu screen consists of 2 pages designated menu 1 and menu 2, and can display up to 29 setting items. Refer to the map on the next page for a description of the menu screen and setup screen display method.

Model 1	14:42	5.6V
Menu	1/2	
Model menu	Acceleration	End point
Curve(EXP)	Idle up	Sub trim
Speed	Engine cut	Ch. Reverse
Mixing menu	Start	Receiver
A.B.S.	Telemetry	Fail-safe

(MENU 1 screen)

Model 1	13:08	6.1V
Menu	2/2	
System menu	Dial select	S.Bus servo
Trigger	SW select	MC-Link
Response	D/R, ATL	Timer
Sensor	Condition	Lap list
Auxiliary	Servo view	

(MENU 2 screen)

Selecting Items On The Menu Screen

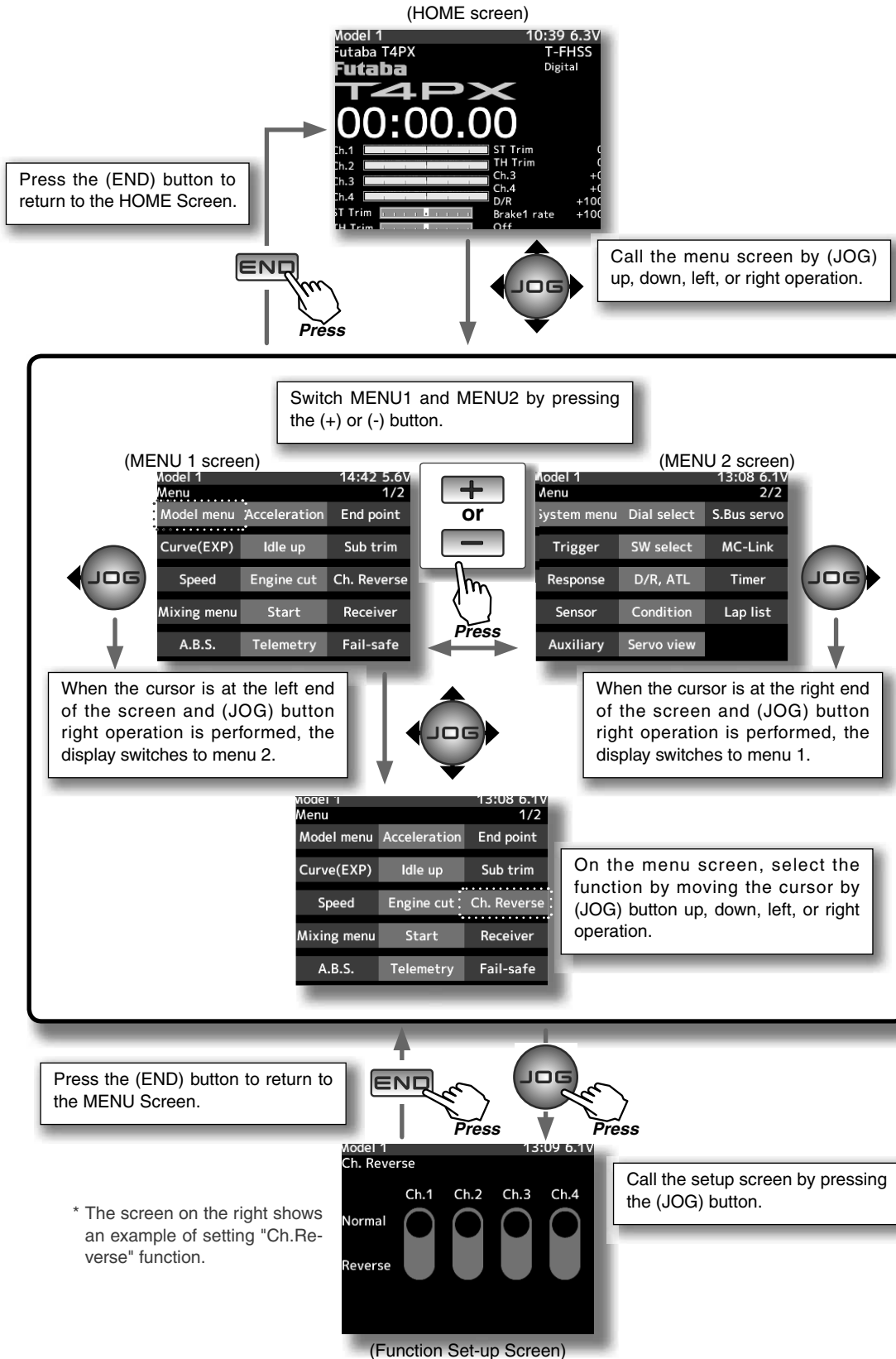

Direct Menu

With the T4PX, setting items often used can be registered as up to 10 direct menus. A different direct menu can be created for each model memory. The direct menus can also be copied to other models by model copy function. (p.114)

Displaying the direct menu screens

The direct menu screens can be displayed by pressing the (DIR) button from any screen.

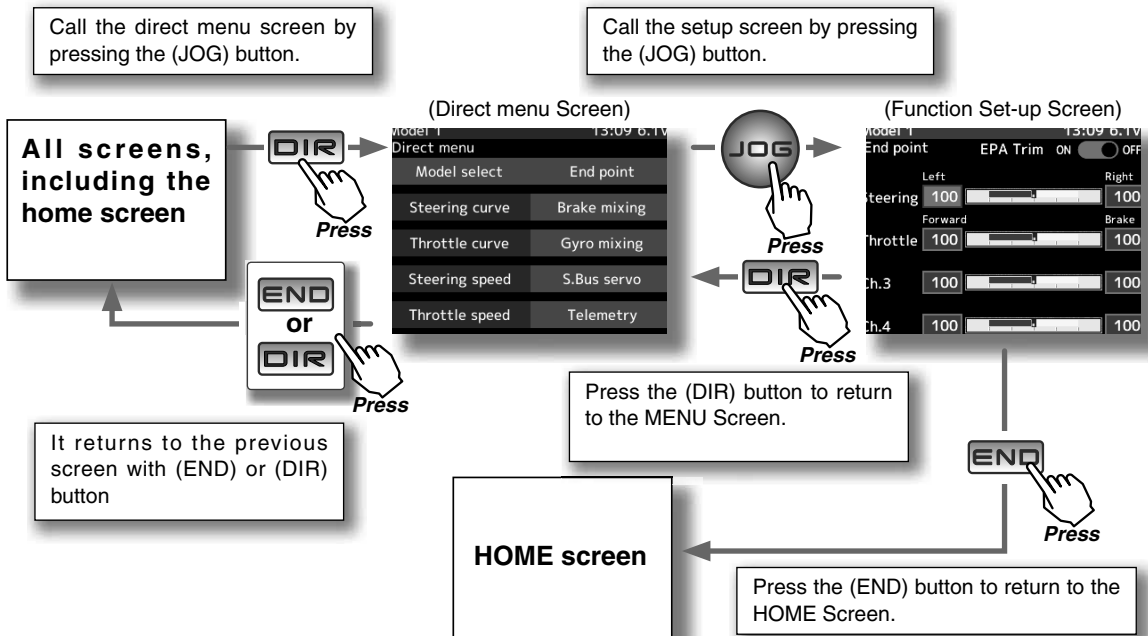

Menu assignment

- 1 Call the direct menu screen by pressing the (DIR) button.
- 2 Move the cursor and select the location to be assigned a function by (JOG) button up, down, left, or right operation.
- 3 Select the function to be assigned by (+) or (-) button.

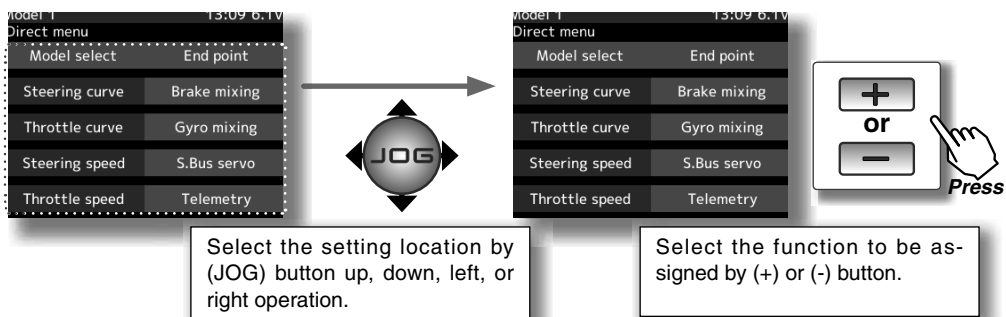
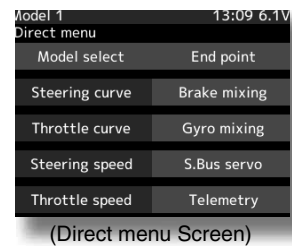

- 4 When assignment is complete, return to the direct menu screen by pressing the (DIR) button.

Function List

Function Name	Description Of Function	Function	Description Of Function
Model select	Model memory call	Servo view	Displays servo operation on a bar graph
Model copy	Model memory copy	D/R,ATL	Steering angle adjustment while running/ Brake side adjustment
LED setting	LED on/off, jog LED on/off	Dial select	Selection of functions operated by digital dial and digital trim
S.BUS servo	S.BUS servo Link software setting	SW select	Selection of functions operated by push switches
Sensor	Telemetry sensors setting	Acceleration	Reduces the "lag time" of the throttle from the neutral position.
Sensor list	Telemetry sensors list	Steering curve	Steering curve adjustment
Telemetry	Telemetry data screen	Throttle curve	Throttle curve adjustment
MC-Link	MC851C/602C/402CR/950CR/940CR/960CR Link software setting function	Steering speed	Steering servo delay
Condition	2ND condition	Throttle speed	Throttle servo delay
User name	User name set/modify	Start	Throttle preset at start function
Battery	Battery type setting	Engine cut	engine cut off by switch
Date and time	Date and time setting	A.B.S	Pumping brake
Calibration	Steering wheel and throttle trigger correction	Brake mixing	Front and rear independent brake control for 1/5GP car, etc.
Display	LCD contrast/backlight setting	Tilt mixing	Outboard engine tilt mixing
End point	End point adjustment	Trigger	Neutral brake and throttle servo forward side and brake side operation rate setting/Trigger SW
Fail safe	Fail safe, battery fail safe	Idle up	Idle up at engine start
Information	Language setting / version information	Program. mixing 1-5	Programmable mixing between arbitrary channels
Model name	Model memory name set/modify	4WS mixing	4WS mixing
Data reset	Model memory reset (Model, Direct menu, All)	Dual ESC	Front and rear ESCs mixing
Ch. Reverse	Servo operation reversing	Gyro mixing	The sensitivity of Futaba car rate gyros can be adjusted
Sound	Sound setting (telemetry sound, alarm sound, operating sound)	CPS mixing	The CPS-1 of Futaba LED controller can be adjusted.
Sub Trim	Servo center position fine adjustment	Steering mixing	Twin servo mixing of the steering
Receiver	Receiver type/servo type selection/linking with telemetry type T-FHSS system receiver	Timer	Up, down, lap, or lap navigation timer
Response	etting of the response	Lap list	Lap timer data (lap time, average lap, best lap time) check
Auxiliary	Channel 3&4 servos operation position set/check	-----	

Receiver Setting / Servo Type

This menu selects the settings matched to the receiver system used and the type of servo and the items selected at the T4PX, linking of the T4PX with the T-FHSS telemetry system, and ON/OFF.

Receiver

The T4PX transmitter can use the S-FHSS and FASST system receivers, as well as the R304SB T-FHSS system receiver supplied. However, only the "C2" type (R614FS/FF/FF-E, etc) receivers can be used with the FASST system. The R603FS/FF "C1" type receiver does not operate. Make your selection by matching to the system of the receiver to be used. The model data remains unchanged even if the receiver setting is changed.

Servos

"Digital servo type" or "Analog servo type" servo type can be selected. However, the "Digital servo type" is for Futaba digital servos (including BLS Series brushless servos) use only. When using other servos, select the "Analog servo type". All servos, including digital servos, can be used in the "Analog servo type".

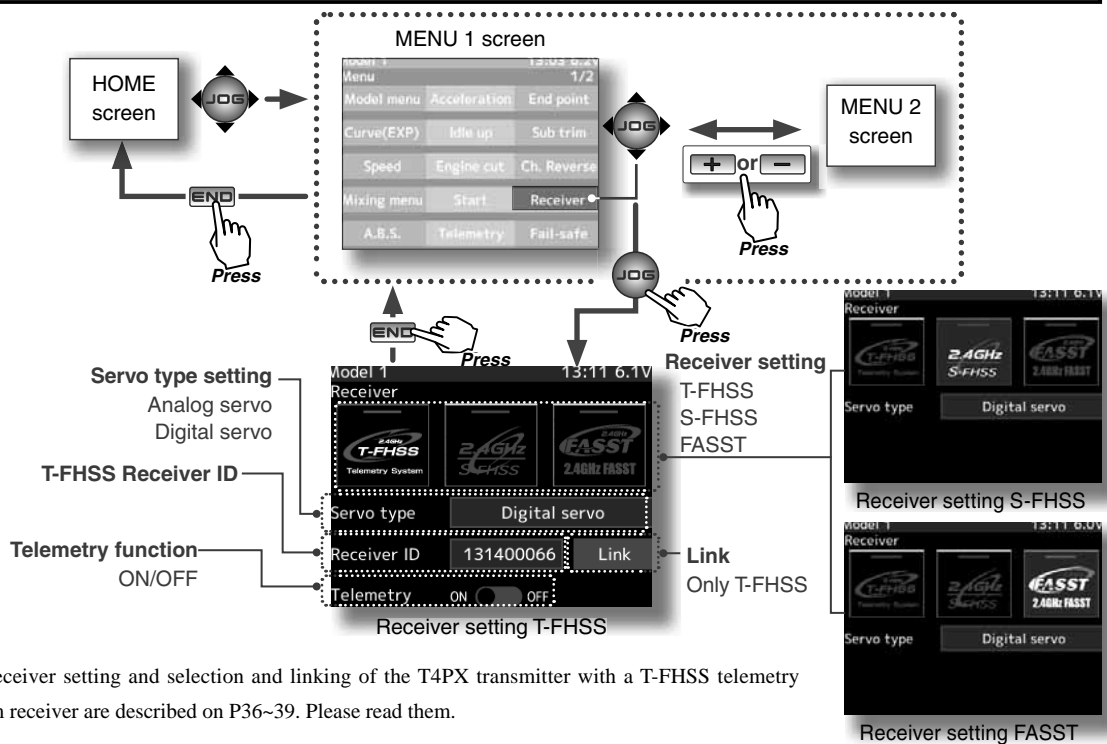

The receiver setting and selection and linking of the T4PX transmitter with a T-FHSS telemetry system receiver are described on P36~39. Please read them.

Telemetry function ON/OFF

Select telemetry by (JOG) button operation.

- 1 (Function ON/OFF)
 - Select the type and ON/OFF by (+) or (-) button.
- 2 When ending, return to the menu screen by pressing the (END) button.

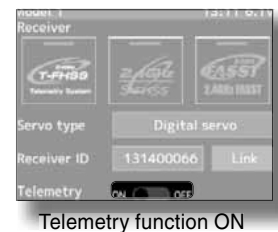

This function reverses the direction of operation of the servos related to transmitter steering, throttle, channel 3, and channel 4 operation.

However, when the position set by trim or subtrim shifts from the center, the center becomes the opposite side.

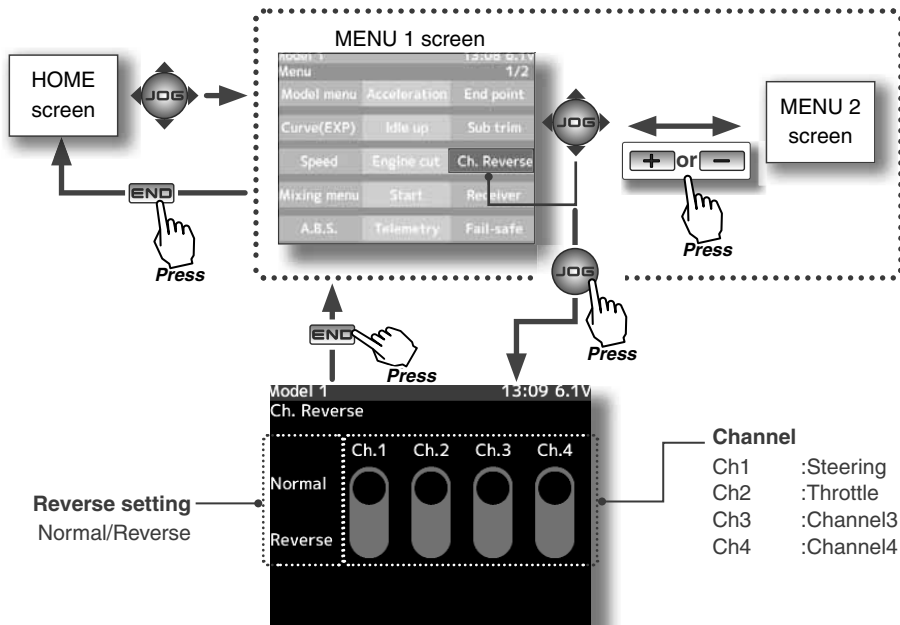

Servo Reverse Function Setting

(Preparation)

Select the channel to be set by (JOG) button left or right operation.

1 (Servo reverse setting)

Use the (+) or (-) button to reverse the servo operation direction.

(Each channel can be set similarly.)

Channel selection

- Select by (JOG) button left or right operation.

Select button

- Select with the (+) or (-) buttons.

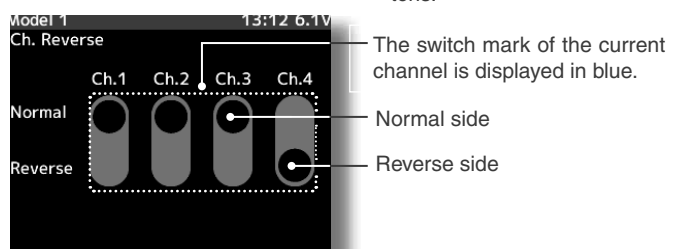

2 When ending setting, return to the menu screen by pressing the (END) button.

Sub trim

(All channel)

Use this function to adjust the neutral position of the steering, throttle, channel 3 and channel 4 servos.

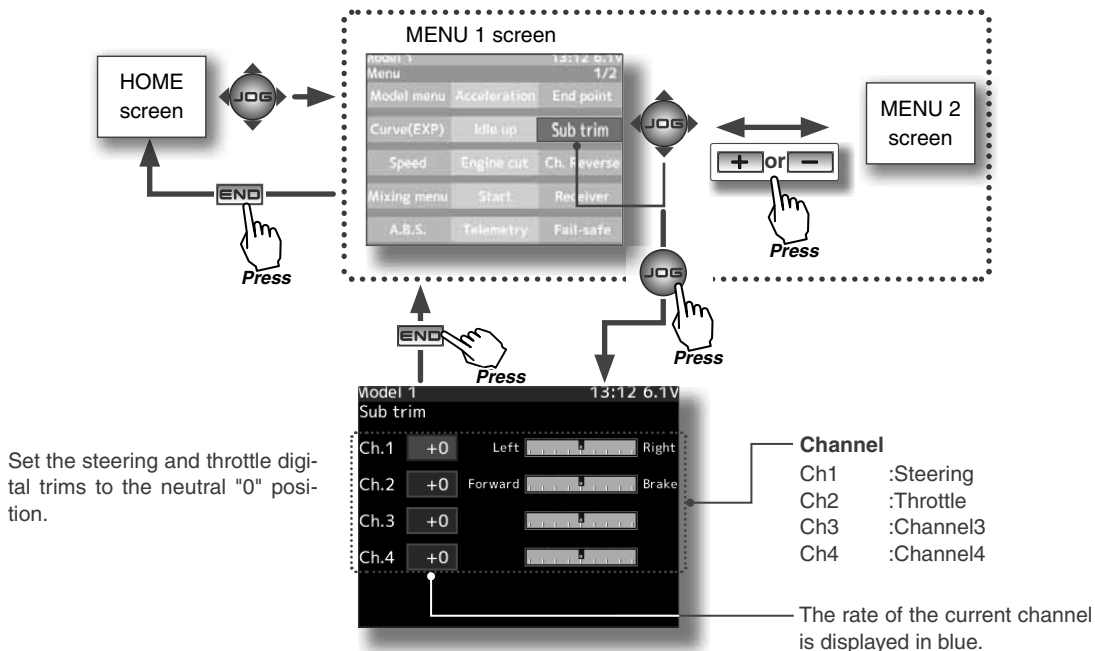
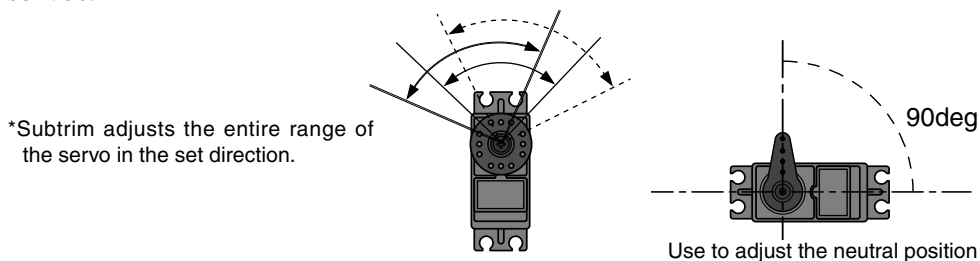

Set the steering and throttle digital trims to the neutral "0" position.

- Channel**
- Ch1 :Steering
 - Ch2 :Throttle
 - Ch3 :Channel3
 - Ch4 :Channel4

The rate of the current channel is displayed in blue.

Sub trim adjustment

(Preparation)

- Set the steering and throttle digital trims to the neutral "0" position. Set CH3 and CH4 to the center "0" position.
- Select the channel to be set by (JOG) button up or down operation.

Channel selection

- Select by (JOG) button up or down operation.

Adjustment buttons

- Adjust with the (+) and (-) buttons.
- Return to the initial value "0" by pressing the (+) and (-) buttons simultaneously for about 1 second.

Subtrim

- CH1 :-100~+100
- CH2 :-100~+100
- CH3 :-100~+100
- CH4 :-100~+100
- Initial value : 0

1 (Subtrim adjustment)

Use the (+) or (-) button to adjust the center.

(Each channel can be set similarly.)

2 When ending setting, return to the menu screen by pressing the (END) button.

End Point Adjuster

(All channel)

Use this when performing left and right end point adjustments, throttle high side/brake side operation amount adjustment, channel 3 and channel 4 servo up side/down side operation amount adjustment during linkage.

- Correct the maximum steering angle for left and right steering angles when there is a difference in the turning radius due to the characteristics, etc. of the vehicle.

Maximum steering angle

The End point function basically determines the maximum steering angle of each channel.

The functions shown below may have been adjusted or the operating range set by End point function may be exceeded. Check the linkage each time the following functions are adjusted.

- Sub trim (all channels)
- Program mixing slave side (all channels)
- Tilt mixing (steering, channel 3)
- Idle up (throttle)
- Start Function, Engine Cut (throttle)
- Throttle acceleration (throttle)

Brake rate trim

Brake rate trim allows adjustment of the brake side operation amount during operation. Therefore, when the operating angle is adjusted with throttle End point, Brake rate trim must also be taken into account.

Remark

When the steering angle is insufficient even though End point is increased to maximum (140%), the steering angle can be increased somewhat by using program mixing. (Setup example: See page 96.)

Warning

❗ Operate each servo over its full stroke and be sure the linkage does not bind or is not loose.

The continuous application of unreasonable force to a servo may cause damage and excessive battery drain.

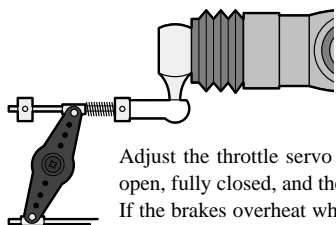

Adjust the throttle servo so that unreasonable force is not applied when the engine carburetor is fully open, fully closed, and the brakes are applied fully.

If the brakes overheat while running, their ability to function properly decreases. Before running, adjust the suitable maximum servo travel so that unreasonable force is not applied even when the servo travel is increased while running.

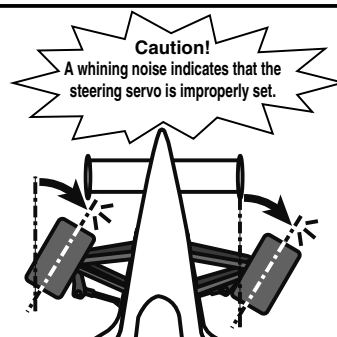

Caution!

A whining noise indicates that the steering servo is improperly set.

Adjust the steering servo so that unreasonable force is not applied to the servo by the chassis at maximum servo travel.

Decide the End point value at the contact point.

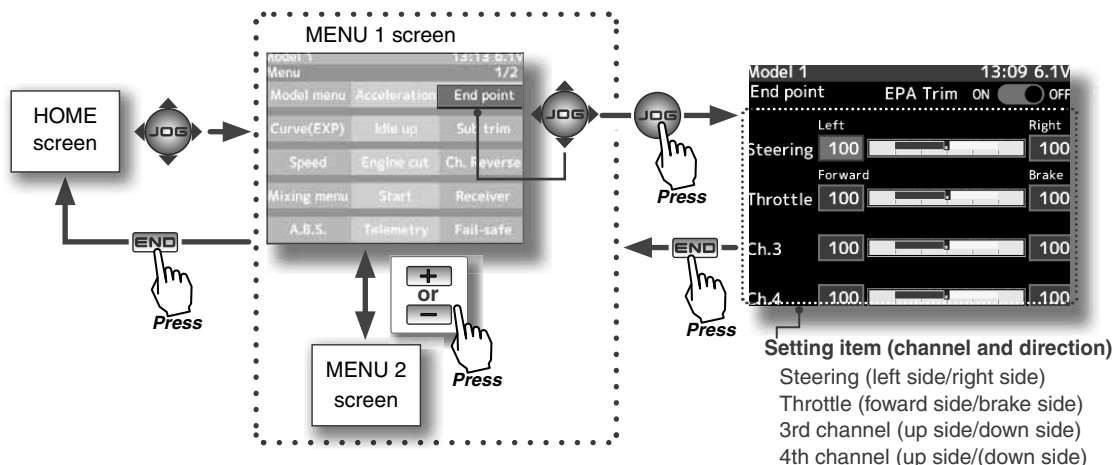

Setting item (channel and direction)
 Steering (left side/right side)
 Throttle (forward side/brake side)
 3rd channel (up side/down side)
 4th channel (up side/(down side)

Steering end point adjustment

(Preparation)

- Before setup of the steering end point adjustment, set the steering D/R dial (initial setup: DT5) to the maximum steering angle position 100%.
- Select the setting item "Steering Left" by (JOG) button operation and make the following adjustments:

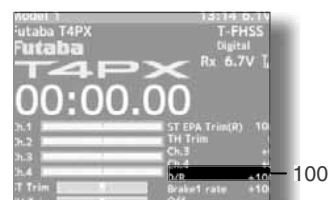

1 Steering (left side) adjustment

Turn the steering wheel fully to the left and use the (+) or (-) buttons to adjust the steering angle.

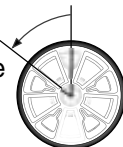

2 Steering (right side) adjustment

Turn the steering wheel fully to the right and use the (+) or (-) buttons to adjust the steering angle.

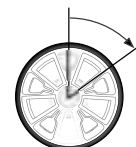

3 When ending setting, return to the menu screen by pressing the (END) button.

Adjustment buttons

Adjust with the (+) and (-) buttons.

- Return to the initial value "100" by pressing the (+) and (-) buttons simultaneously for about 1 second.

Note

Step #1 & #2 are done when the receiver is in the on position installed on the chassis. You're watching the wheels reach their maximum end point.

Steering End point :0~140
 Initial value :100

Quick EPA

When EPA trim is turned on, the steering angle (end point) can be adjusted by steering trim set digital trim or dial. (Steering trim initial setting: DT1)



Steering left side adjustment

With the steering wheel turned fully to the left, steering is adjusted by steering trim. Temporarily displayed at this part of the HOME screen as shown in the figure below.

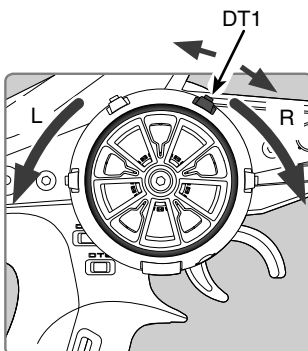
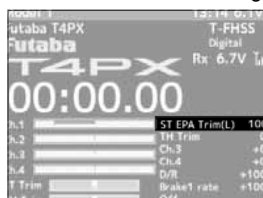

Steering right side adjustment

With the steering wheel turned fully to the right, steering is adjusted by steering trim. Temporarily displayed at this part of the HOME screen as shown in the figure below.

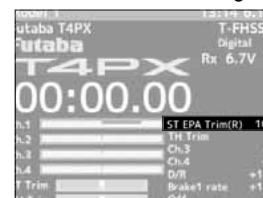

Throttle end point adjustment

(Preparation)

- Before setting the throttle end point adjustment, set the throttle ATL dial (initial setup: DT6) to the maximum throttle angle position 100%.
- Select the setting item "Throttle Forward" by (JOG) button operation and make the following adjustments:



1 Throttle (forward side) adjustment

Pull the throttle trigger fully to the high side and use the (+) or (-) buttons to adjust the throttle angle. However, when using an FET amp, set to 100%.

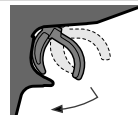

2 Throttle (brake side/reverse side) adjustment

Move the throttle trigger fully to the brake side and use the (+) or (-) buttons to adjust the throttle angle. However, when using an ESC, set to 100%.

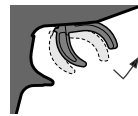

- ### 3
- When adjusting the throttle angle of another channel immediately after this, see the adjustment method for that channel. When ending setting, return to the menu screen by pressing the (END) button.

Adjustment buttons

- Use the (+) and (-) buttons to make adjustments.
- Return to the initial value "100" by pressing the (+) and (-) buttons simultaneously for about 1 second.
- Please see previous note on page 50.

Throttle End point :0~140
Initial value :100

When Trigger Ratio (p.66) was set to 100:0, brake operation is stopped and the throttle (brake side) cannot be adjusted.

3rd & 4th channel servo end point adjustment

(Preparation)

- Select the channel whose steering angle is to be adjusted and the direction by (JOG) button operation.

- ### 1
- Use the (+) or (-) buttons to adjust the servo angle.

Adjustment buttons

- Use the (+) and (-) buttons to make adjustments.
- Return to the initial value "100" by pressing the (+) and (-) buttons simultaneously for about 1 second.
- Please see previous note on page 50.

3rd & 4th channel End point
:0~140
Initial value :100

Spare channel display

When a mixing function is set at a spare channel, the display changes.

This is an example of setting dual ESC mixing at the 3rd channel and 4WS mixing at the 4th channel.

Dual ESC mixing :Front ESC

4WS mixing: Rear servo

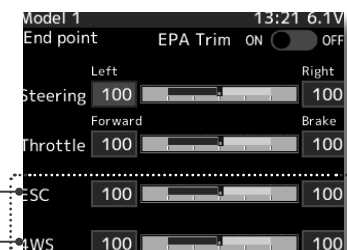

- ### 2
- When ending setting, return to the menu screen by pressing the (END) button.

Acceleration (Throttle Acceleration)

(Throttle system)

The servo will jump to the input position at its maximum possible speed. Unlike exponential, which adjusts the whole throttle movement into a curve, throttle acceleration simply "jumps" away from neutral and then leaves the remaining response linear.

Operation

- Operation near the throttle trigger neutral position becomes a sharp rise.
- The forward and brake sides can be set separately.
- When the brake mixing function (p.80) is set, the CH3/CH4 brake can also be set.

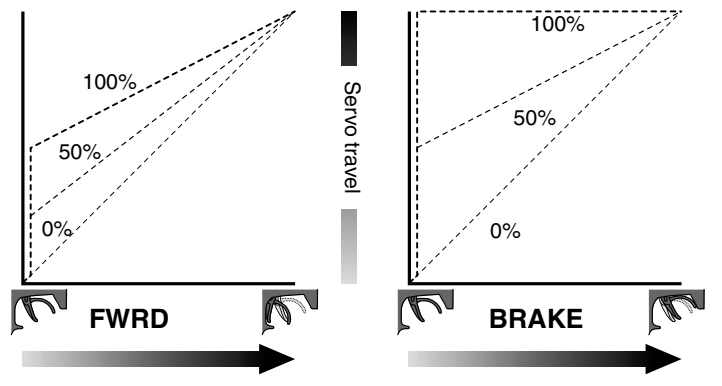

Set value

The standard value (100% point) of this setup affects the operation amount set by throttle end point function.

Convenient usage method

For gasoline engine cars, the linkage must have a clearance because one servo controls the engine carburetor and brake. Thus, there is a noticeable time delay at both the forward and brake sides. Sharp response comparable to that of electric motor cars is obtained by reducing this clearance at the transmitter side.

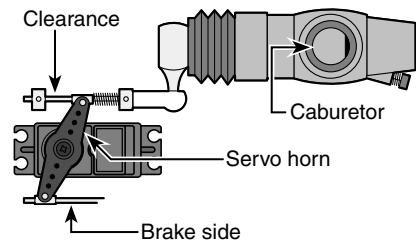

Function

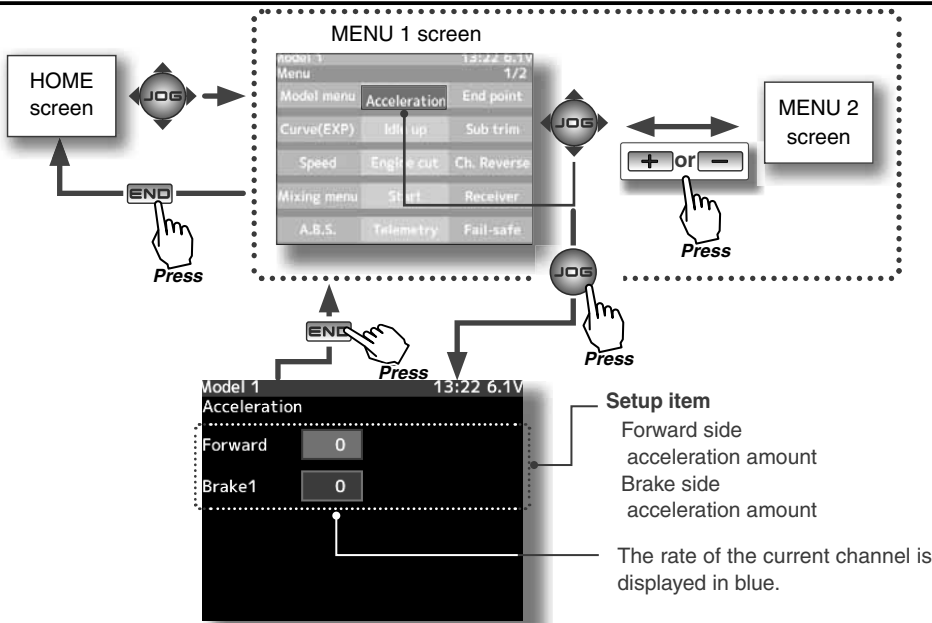

Throttle acceleration adjustment

(Preparation)

- Select the setting item "Forward" by (JOG) button up or down operation and make the following adjustments:

1 (Forward acceleration amount adjustment)

Use the (+) and (-) buttons to adjust the acceleration amount.

- "0" :No acceleration
- "100" :Maximum acceleration (Approximately 1/2 of the forward side throttle angle)

2 (Brake side acceleration amount adjustment)

Select the setting item "Brake1" by (JOG) button up or down operation and use the (+) and (-) buttons to adjust the acceleration amount.

- "0" :No acceleration
- "100" :Maximum acceleration (Brake side maximum throttle angle)

3 (3rd & 4th channel brake side acceleration amount adjustment)

If the "Brake Mixing Function" (p.80) is being set, the 3rd or 4th channel brake side acceleration will become adjustable.

Select the setting item "Brake 2" or "Brake3" by (JOG) button up or down operation and adjust acceleration amount by (+) or (-) button.

- "0" :No acceleration
- "100" :Maximum acceleration (Brake side maximum throttle angle)

Adjustment buttons

- Adjust with the (+) and (-) buttons.
- Return to the initial value "0" by pressing the (+) and (-) buttons simultaneously for about 1 second.

Forward acceleration amount (Forward)

0~100
Initial value: 0

Brake side acceleration amount (Brake1)

0~100
Initial value: 0

3rd/4th channel brake side acceleration amount (Brake2),(Brake3)

0~100
Initial value: 0



Brake2

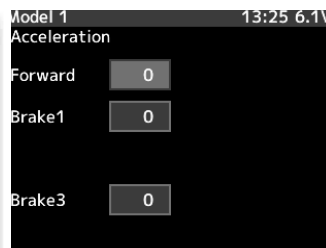

Brake3

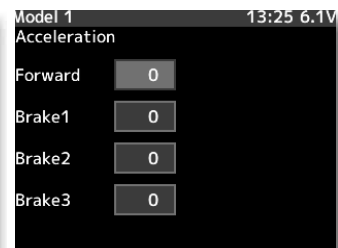

Brake2 & 3

- ### 4
- When ending setting, return to the menu screen by pressing the (END) button.

Caution

When Trigger Ratio (p.66) was set to 100:0, brake operation is stopped and the throttle (brake side) cannot be adjusted.

Dial / Trim Setting

The throttle acceleration adjustment amount (Forward), (Brake1), 3rd channel and 4th channel (Brake2, Brake3) can be controlled with digital trim DT1-DT6 or digital dial DL1 etc. with the function select dial function. (p.101)

Fail Safe/Battery Fail Safe Function (All channel)

This function sets the servo operation position when transmitter signals cannot be received by the receiver for some reason or the battery voltage has dropped.

-Fail safe mode

This function moves each servo to a preset position when the receiver cannot receive the signals from the transmitter for some reason.

*The fail safe data is transferred from the transmitter to the receiver 10 seconds after the transmitter power was turned on.

The data is transferred every 10 seconds after that. Be careful because normally the transmitter power is turned on first and the receiver power is turned on next and there is no data transfer for about 10 seconds after the receiver power is turned on.

*For gasoline engine cars, for safety we recommend that this fail safe function be used to set the throttle channel in the direction in which the brakes are applied.

-Hold mode

This function holds the receiver in its position immediately before reception was lost.

-Off mode (OFF)

This function stops output of signals to the servos and places the servos into the free state when the receiver cannot receive.

The F/S, HOLD, and OFF modes are automatically reset when signals from the transmitter can be received again

-Battery fail safe function (B-F/S)

If the receiver battery voltage drops below a certain value when this function is enabled, the throttle servo moves to the position set by fail safe function. When the battery voltage recovers, the battery fail safe function is automatically reset.

*This function cannot be used when the channel is not set to fail safe.

*When the receiver setting (P36) is "FASST", only CH2 (throttle) can use this function.

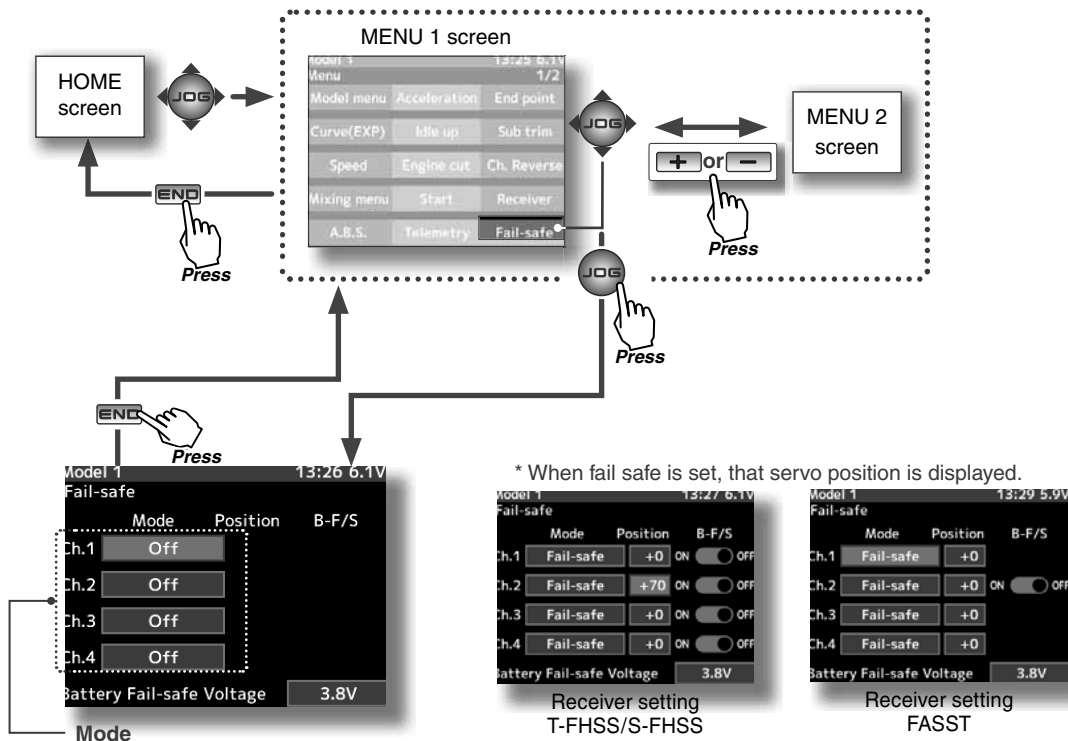

Fail safe mode selection

(Preparation)

- Select the channel to be set by (JOG) button operation.

1 (Mode selection)

Select the mode by (+) or (-) button.

(Each channel can be individually set.)

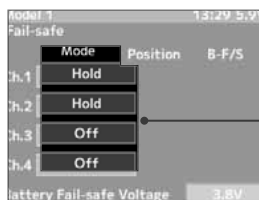

Setup item selection

- Select by (JOG) button up or down operation.

Fail safe mode selection

- Select with the (+) or (-) buttons.

Fail safe mode

Off, Hold, Fail-safe

2 When ending hold or off mode setting, return to the HOME screen by pressing the (END) button. When setting fail safe, set the servo position by the following method.

Fail safe function setup

1 (Servo position setup)

When the fail safe function operates, select the channel's "Position" to be set by (JOG) button operation.

The steering wheel, the throttle trigger or 3rd, 4th channels dial remains in the desired operation position. When the (JOG) button are pressed simultaneously for about 1 second, the servo position is displayed and you can confirm that the function was set.

(Each channel can be set similarly.)

Fail safe position setup button

- The (JOG) button are pressed simultaneously for about 1 second.

2 When ending setting, return to the HOME screen by pressing the (END) button.



Battery fail safe function ON/OFF & BATT-F/S voltage setting

1 (Battery fail safe function ON/OFF)

Select "OFF" or "ON" of "B-F/S" by (JOG) button operation. Set B-F/S function ON/OFF by (+) or (-) button.

2 (Battery fail safe voltage setting)

Select battery fail safe **V at the bottom of the screen by (JOG) button operation. Set the voltage that turns on the B-F/S function by (+) or (-) button.

(Since R604 Series receivers are not for high voltage use, the use of LiFe and Li-Po batteries is prohibited. Therefore, the 4.8v and 5.6v settings are prohibited.)



Battery fail safe function

OFF, ON
Initial value: OFF

BATT-F/S Voltage

T-FHSS
3.5,3.8,4.0,4.2,4.4,4.6,4.8,5.0,
5.3,5.6,5.9,6.2,6.5,6.8,7.1,7.4V
FASST
3.5,3.8,4.4,4.75
5.5V(Only R614)
S-FHSS
Only 3.8V

Example:

Ni-MH /Ni-Cd 4cell---3.8V
Ni-MH /Ni-Cd 6cell---4.4V
LiFe 2cell---4.8V
Li-Po 2cell---5.6V

3 When ending setting, return to the menu screen by pressing the (END) button.

When the receiver power supply of an electric car uses a common power supply from an ESC, we recommend that this function be set to OFF because the voltage supplied to the receiver may drop momentarily and the battery fail safe function may be activated.

This function is used to change the sensitivity of the steering servo around the neutral position. It has no effect on the maximum servo travel.

Racers Tip

When the setting is not determined, or the characteristics of the model are unknown, start with 0%. (When EXP is set to 0%, servo movement is linear.)

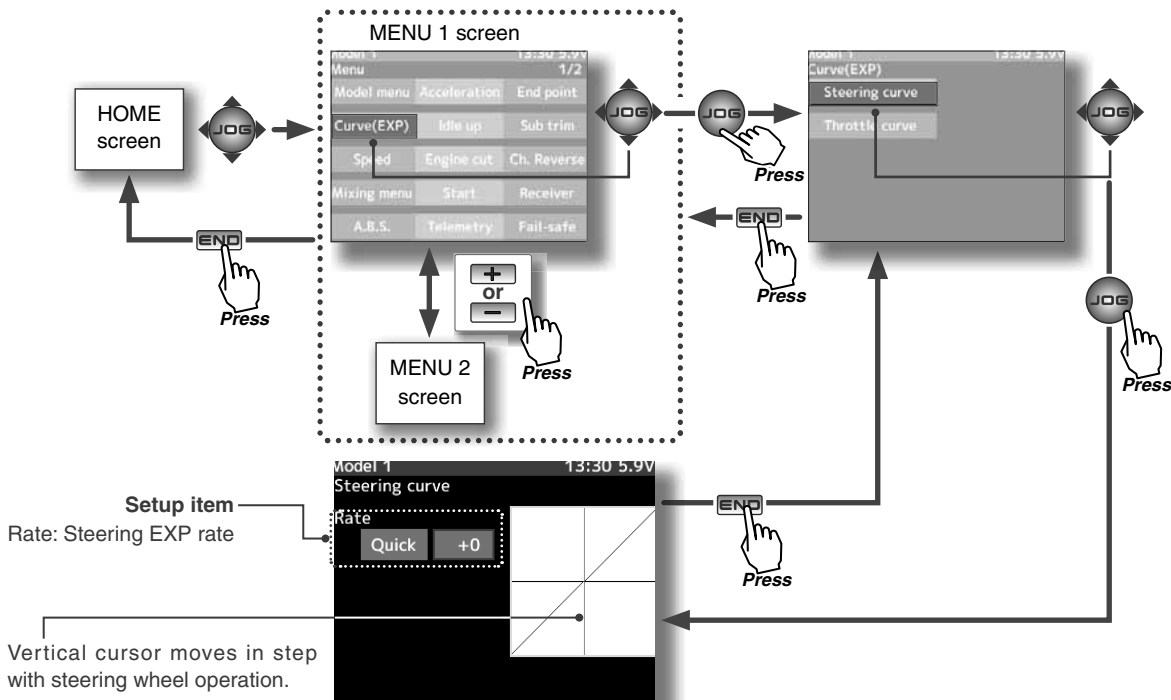

Dial / Trim Setting

The steering EXP adjustment can be controlled with digital trim DT1~DT6 or digital dial DL1 etc. with the function select dial function. (p.101)

Steering EXP adjustment

- When you want to quicken steering operation, use the (+) button to adjust the + side. When you want to make steering operation milder, use the (-) button to adjust the - side.

Adjustment buttons

- Adjust with the (+) and (-) buttons.
- Return to the initial value "0" by pressing the (+) and (-) buttons simultaneously for about 1 second.

Adjustment range

-100~0~+100%

When the setting item "Quick or mild" is selected and the (JOG) button is pressed when the rate is other than "0", quick/mild are reversed.

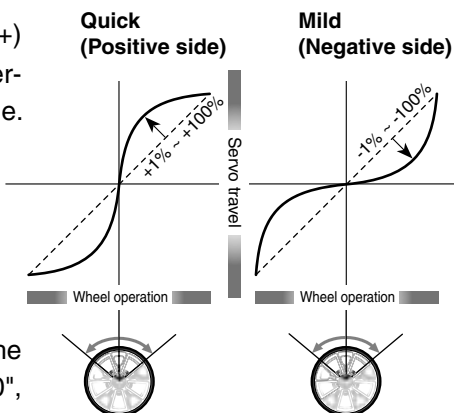

- When ending setting, return to the curve screen by pressing the (END) button.

Throttle curve

(Throttle system)

This function makes the throttle high side and brake side direction servo operation quicker or milder. It has no effect on the servo maximum operation amount.

For the high side, selection from among three kinds of curves (EXP/VTR/Curve) is also possible.

Advice

When the course conditions are good and the surface has good grip, set each curve to the + side (quick side). When the road surface is slippery and the drive wheels do not grip it, set each curve to the - minus (mild) side.

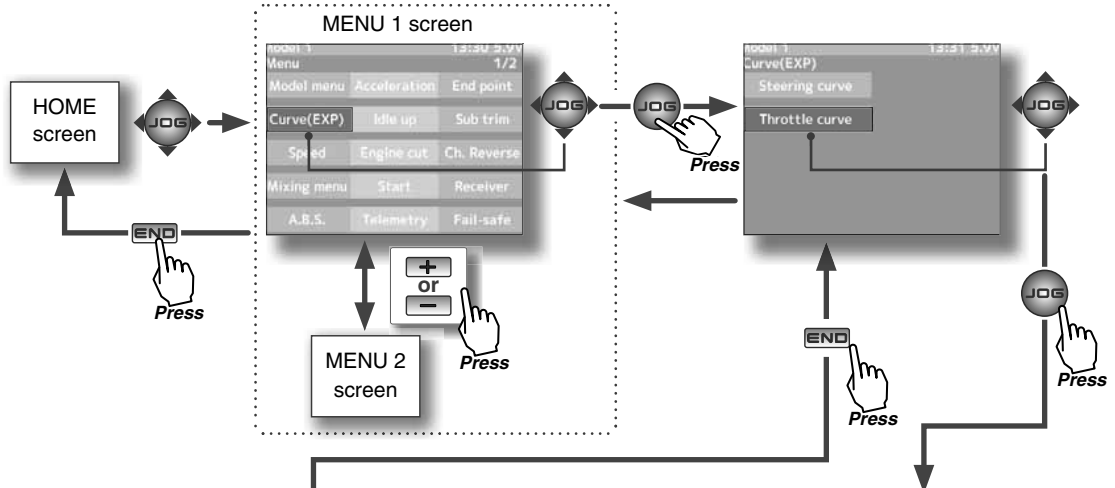

Curve selection

First, select the type of forward side curve at the "Type" item. The setup item (screen) varies with the type of curve. The figure at the above is the EXP curve setup screen.

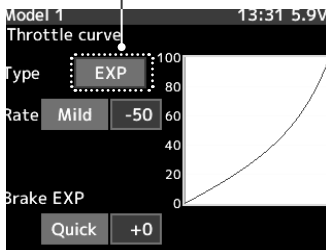

EXP curve screen

Curve type which operates the throttle from the neutral point to the high point on a curved curve.

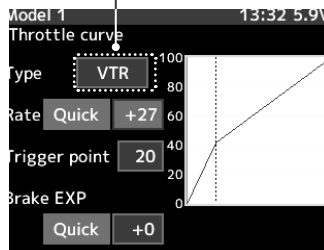

VTR curve screen

Curve type which sets the switching point between the throttle neutral point and high point and operates the throttle on a linear curve.

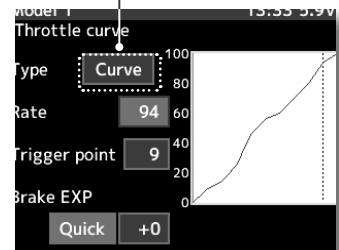

CRV curve screen

Curve type which sets 9 points between the throttle neutral point and high point and operates the throttle.

Caution

When Trigger Ratio (p.66) was set to 100:0, brake operation is stopped and the throttle (brake side) cannot be adjusted.

Dial / Trim Setting

The throttle EXP curve and VTR curve adjustment (Forward side RATE) and (Brake side RATE) can be controlled with digital trim DT1~DT6 or digital dial DL1 etc. with the function select dial function. (p.101)

Function

Adjustment method for EXP curve

(Preparation)

- Select the "Type" to be set by (JOG) button operation.

With the plus (+) or minus (-) buttons, select "EXP".

Setup items

Type :Forward side curve selection

Rate :Forward side rate

Brake-EXP :Brake side rate

Setup item selection

- Select by (JOG) button up or down operation.

Curve type Select button

- Select with the (+) or (-) buttons.

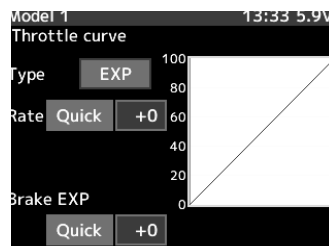

1 Forward Exponential Adjustment

Select the "Rate" to be set by (JOG) button operation.

Use the plus (+) button to adjust for a faster throttle response or use the minus (-) button for a slower or milder throttle response.

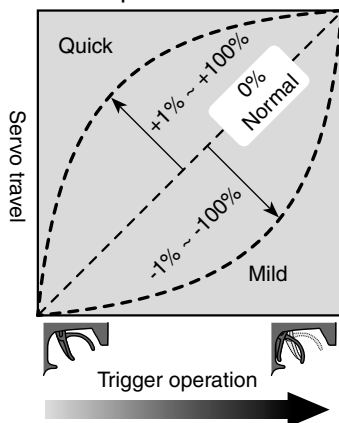

Adjustment range

Rate: -100 ~ 0 ~ +100%

Adjustment buttons

Adjust with the (+) and (-) buttons.

- Return to the initial value "0" by pressing the (+) and (-) buttons simultaneously for about 1 second.

2 Brake Exponential Adjustment

Select the "Brake EXP" to be set by (JOG) button operation.

Use the plus (+) button to adjust for a faster brake response or use the minus (-) button for a slower or milder brake response.

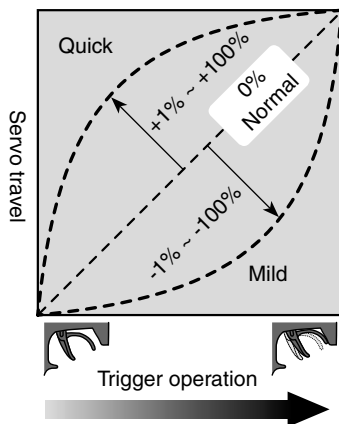

Adjustment range

Brake-EXP: -100 ~ 0 ~ +100%

Adjustment buttons

Adjust with the (+) and (-) buttons.

- Return to the initial value "0" by pressing the (+) and (-) buttons simultaneously for about 1 second.

Quick/mild is reversed by (JOG) button, the same as the forward side.

3 When ending setting, return to the curve screen by pressing the (END) button.

Adjustment method for VTR curve

(Preparation)

- Select the "Type" to be set by (JOG) button operation.

With the plus (+) or minus (-) buttons, select "VTR"

Setup items

Typ :Forward side curve selection

Rate :Forward side rate

Triger point :Curve switching point

Brake-EXP :Brake side rate

Setup item selection

- Select by (JOG) button up or down operation.

Curve type Select button

- Select with the (+) or (-) buttons.

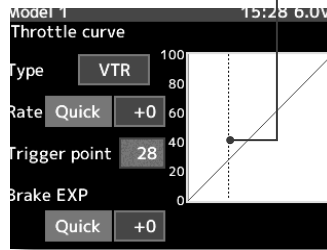

Switching point

A vertical cursor line that shows the curve switching point is displayed on the setup screen graph.

1 Forward side adjustment

Select the "Rate" to be set by (JOG) button operation. Use the plus (+) button to adjust for a faster response. Use the minus (-) button for a slower or mild response. -Plus (+) button- the higher the number goes on the positive side, the faster the response will be at center of throttle response. -Minus (-) button- the higher the number goes on the negative side, the milder or softer it is in the center of the throttle response.

2 Curve switching point adjustment

Select the "Trigger point" to be set by (JOG) button operation. Use the plus (+) or minus (-) buttons to move the point you prefer. This gives you the opportunity of switching the curve point in relation to the throttle trigger position.

Adjustment range

Rate :-100 ~ 0 ~ +100%

Trigger point :20 ~ 80%

Brake-EXP:-100 ~ 0 ~ +100%

Adjustment buttons

Adjust with the (+) and (-) buttons.

- Return to the initial value by pressing the (+) and (-) buttons simultaneously (approx. 1 sec).

Initial value:

Rate and Brake-EXP "0"

Trigger point "50"

3 Brake side adjustment

Select the "Brake EXP" to be set by (JOG) button operation. Use the plus (+) button to adjust for a faster brake response or use the minus (-) button for a slower or milder brake response. When the setting item "Quick or mild" is selected and the (JOG) button is pressed when the rate is other than "0", quick/mild are reversed.

4 When ending setting, return to the curve screen by pressing the (END) button.

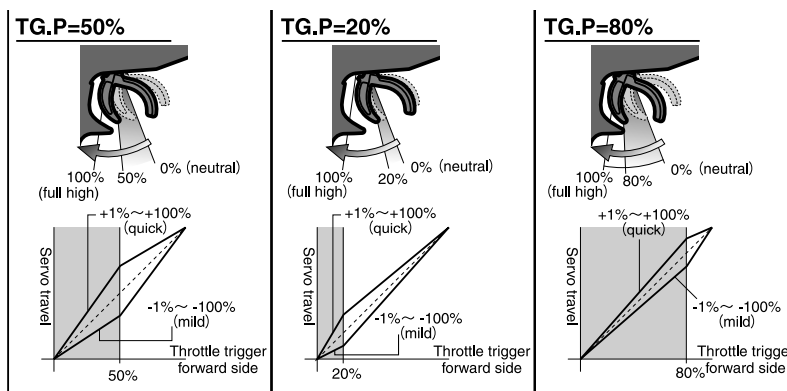

For the VTR curve, only the high side can be set. The brake becomes the EXP curve.

Throttle curve

Adjustment method for VTR curve

(Preparation)

- Select the "Type" to be set by (JOG) button operation.

With the plus (+) or minus (-) buttons, select "Curve".

Setup items

Type :Forward side curve selection

Rate :Forward side rate

Trigger point :Curve points 1~9

Brake-EXP :Brake side rate

Setup item selection

- Select by (JOG) button up or down operation.

Curve type Select button

- Select with the (+) or (-) buttons.

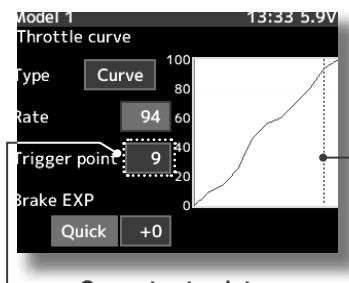

Current set point

The current set point and the trigger point are displayed by a vertical cursor on the graph.

1 Curve setup

- Select the setting item "1:" (1st point), by (JOG) button up, down, left, or right operation, and use the (+) and (-) buttons to set the 1st point. Set the throttle curve by sequentially setting "2:" (2nd point) ~ "5:" (5th point).

Adjustment range

1: ~ 9 : 0 ~ 100%

Trigger point :1~9

Brake-EXP -100 ~ 0 ~ +100%

2 Brake side adjustment

Select the setting item "Brake EXP" by (JOG) button up or down operation. When you want to quicken the rise, use the (+) button to adjust the + side and when you want to make the rise milder, use the (-) button to adjust the - side. When the setting item "Quick or mild" is selected and the (JOG) button is pressed when the rate is other than "0", quick/mild are reversed.

For the CRV curve, only the forward side can be set. The brake becomes the EXP curve.

Adjustment buttons

Adjust with the (+) and (-) buttons.

- Return to the initial value by pressing the (+) and (-) buttons simultaneously (approx. 1 sec).

Initial value:

Point.1:10, 2:20, 3:30, 4:40,

5:50, 6:60, 7:70, 8:80, 9:90

Brake-EXP "0"

3 When ending setting, return to the curve screen by pressing the (END) button.

Throttle curve

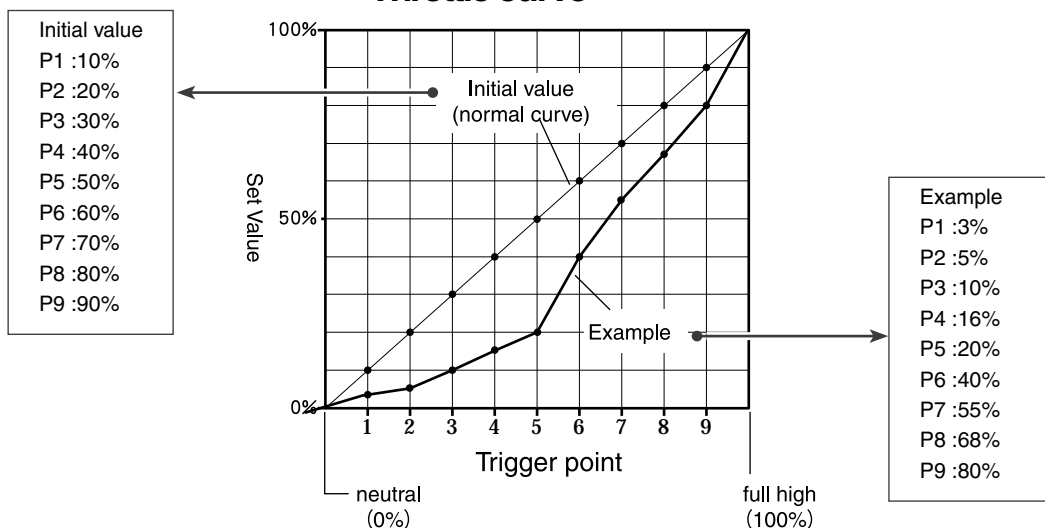

Steering Speed

(Steering system)

Quick steering operation will cause momentary understeering, loss of speed, or spinning. This function is effective in such cases.

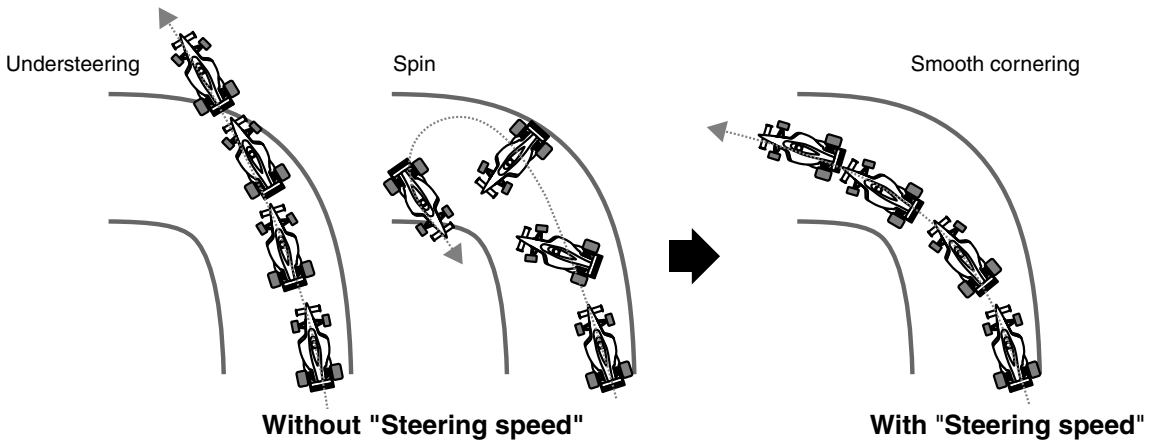

Operation

- This function limits the maximum speed of the steering servo. (Delay function)
- The steering speed when the steering wheel is operated (Turn direction) and returned (Return direction) can be independently set.
- If the steering wheel is turned slower than the set speed, the steering servo is not affected.

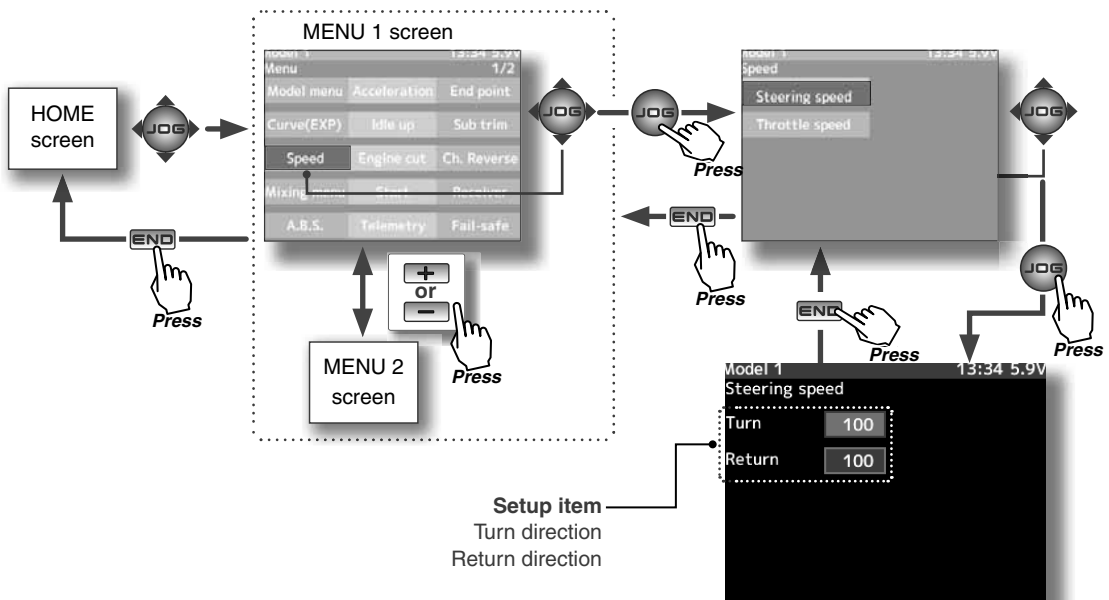
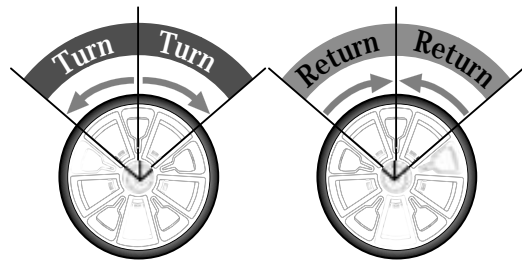

Function

Steering Speed adjustment

(Preparation)

- Select the setting item "Turn" by (JOG) button up or down operation, and make the following adjustments:

1 "Turn" direction adjustment

Use the (+) or (-) buttons to adjust the delay amount.

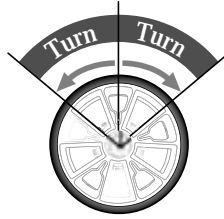

Setup item selection

- Select by (JOG) button up or down operation.

Adjustment range

1~100% (each direction)
At 100%, there is no delay.

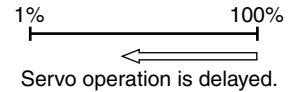

Servo operation is delayed.

2 "Return" direction adjustment

Select the setting item "Return" by (JOG) button up or down operation, and use the (+) or (-) buttons to adjust the delay amount.



Adjustment buttons

- Adjust with the (+) and (-) buttons.
- Return to the initial value "0" by pressing the (+) and (-) buttons simultaneously for about 1 second.

- ### 3
- When ending setting, return to the speed screen by pressing the (END) button.

Dial / Trim Setting

The steering speed adjustment "Turn" and "Return" can be controlled with digital trim DT1-DT6 or digital dial DL1 etc. with the function select dial function. (p.101)

Throttle Speed

(Throttle system)

Sudden throttle trigger operation on a slippery road only causes the wheels to spin and the vehicle cannot accelerate smoothly. Setting the throttle speed function reduces wasteful battery consumption while at the same time permitting smooth, enjoyable operation.

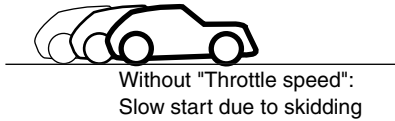

Operation

-Throttle servo (ESC) operation is delayed so that the drive wheels will not spin even if the throttle trigger is operated more than necessary. This delay function is not performed when the throttle trigger is returned and at brake operation.

-1 speed, 2 speed, or 3 speed can be selected.

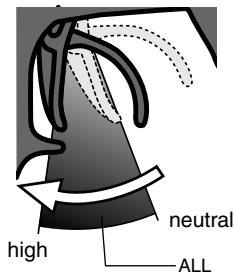

1 SPEED

A delay is set over the entire throttle range.

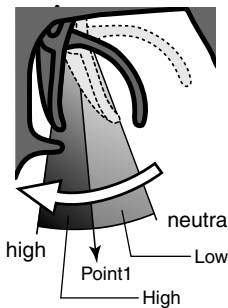

2 SPEED

A delay can be set in 2 ranges with Point1 as the boundary.

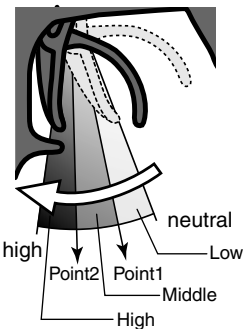

3 SPEED

A delay can be set in 3 ranges with Point1 and Point2 as the boundaries.

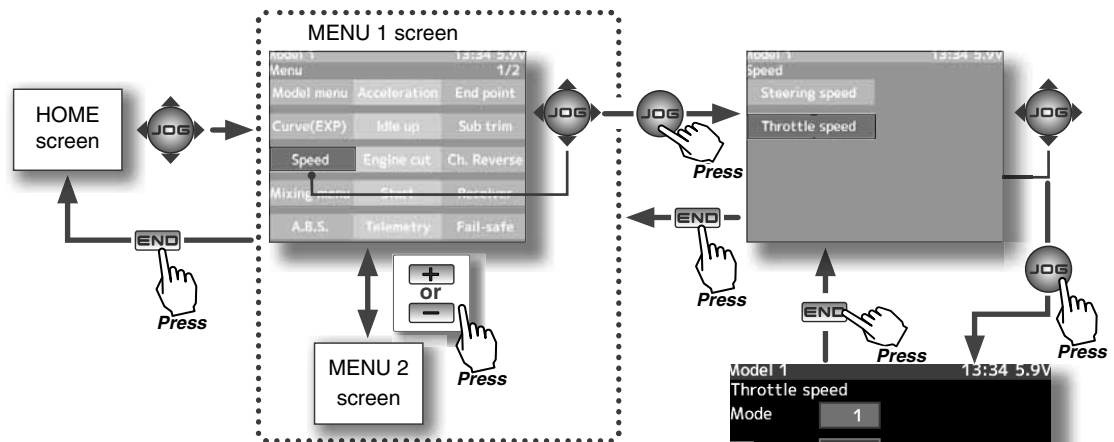

Function

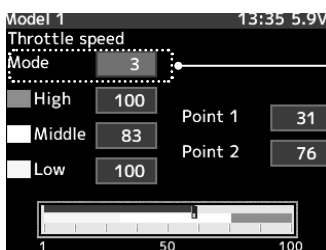

Mode selection

One speed, 2 speed, or 3 speed can be selected at the "Mode" item. The setting item (screen) depends on the mode. The figure at the above is the 3 speed setup screen.

Adjustment method for 1 Speed

(Preparation)

- Select the setting item "Mode" by (JOG) button up or down operation. Press the (+) or (-) button and select "1".

Setting item

Mode :Speed type selection
All :Speed adjustment

Setup item selection

- Select by (JOG) button up or down operation.

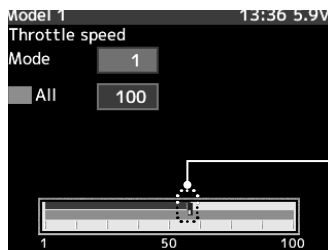

Speed type Select button

- Select with the (+) or (-) buttons.

Throttle trigger position

1 ("ALL" delay adjustment)

Select "All" by (JOG) button up or down operation.

Use the (+) or (-) button to adjust the delay of the entire throttle forward side range.

2 When ending setting, return to the speed screen by pressing the (END) button.

Adjustment range

1~100% (each direction)
At 100%, there is no delay.

Adjustment buttons

- Adjust with the (+) and (-) buttons.
- Return to the initial value "100" by pressing the (+) and (-) buttons simultaneously for about 1 second.

Adjustment method for 2 Speed

(Preparation)

- Select the setting item "Mode" by (JOG) button up or down operation. Press the (+) or (-) button and select "2".

Setting item

Mode :Speed type selection
High :High side range speed adjustment
Low :Low side range speed adjustment
Point1 :Low and medium speed switching point

Setup item selection

- Select by (JOG) button up or down operation.

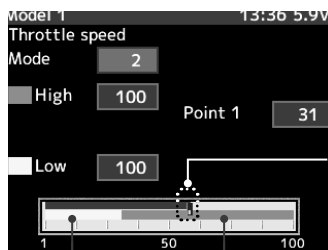

Speed type Select button

- Select with the (+) or (-) buttons.

Throttle trigger position

The Low and High ranges are linked to the Point1 set point and displayed.

1 ("Low" and "High" delay adjustment)

Select "Low" or High" by (JOG) button up or down operation.

Use the (+) or (-) button to adjust the delay of the entire throttle forward side range.

2 (Speed switching point adjustment)

When you want to change the "Low" and "High" switching point, select the setting "Point1" by (JOG) button up or down operation.

3 When ending setting, return to the speed screen by pressing the (END) button.

Adjustment range

High :1~100
Low :1~100
At 100%, there is no delay.
Point1 :1~100

Adjustment buttons

- Adjust with the (+) and (-) buttons.
- Return to the initial value by pressing the (+) and (-) buttons simultaneously (approx. 1 sec).
Initial value
Low, High : "100"
Point1 :30

Adjustment method for 3 Speed

(Preparation)

- Select the setting item "Mode" by (JOG) button up or down operation. Press the (+) or (-) button and select "3".

Setting item

Mode :Speed type selection
High :High side range speed adjustment
Middle :Medium speed range speed adjustment
Low :Low side range speed adjustment
Point1 :Low and medium speed switching point

Setup item selection

- Select by (JOG) button up or down operation.

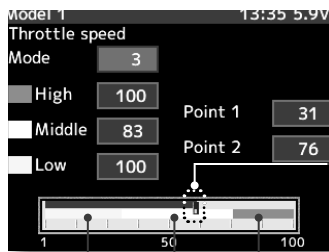

Speed type Select button

- Select with the (+) or (-) buttons.

Throttle trigger position

The Low and High ranges are linked with the Point1,2 set points and displayed.

1 ("Low", "Middle", and "High" delay adjustment)

Select the setting item "Low", "Middle", or "High" by (JOG) button up or down operation.

2 (Speed switching point adjustment)

When you want to change the "Low", "Middle", and "High" switching point, select setting item "Point1" or "Point2" by (JOG) button up or down operation.

Adjustment range

High :1~100
Middle :1~100
Low :1~100
At 100%, there is no delay.
Point1 :1~100
Point2 :1~100

Adjustment buttons

- Adjust with the (+) and (-) buttons.
- Return to the initial value by pressing the (+) and (-) buttons simultaneously (approx. 1 sec).
Initial value
Low, Middle, High:"100"
Point1 :30
Point2 :60

3 When ending setting, return to the speed screen by pressing the (END) button.

-The neutral brake function is a function switch function (p.99), and setting the neutral brake function ON/OFF switch is necessary.

Neutral brake, which applies the brakes at the throttle trigger neutral position, can be set. However, for Futaba speed controller (ESC) MC960CR, MC950CR, MC851C, MC602C, MC402CR, etc, considering safety, when the neutral position is not confirmed, the set will not enter the operation mode to prevent the motor from rotating instantly when the power is turned on. When using the MC960CR, MC950CR, MC851C, MC602C, MC402CR, etc., check that the ESC is in the neutral position and set the neutral brake function switch to ON after the set enters the operation mode.

Operation display

The **N-B** display appears on the home screen.

-This function allows selection of the forward side and brake (reverse) side operation ratio from 70:30, 50:50 or 100:0 by changing the neutral position of the throttle servo.

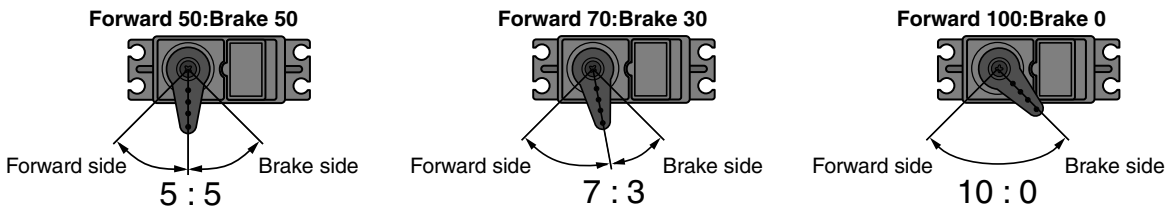

When trigger ratio was set to 100:0

When the trigger ratio was set to 100:0, brake operation stops and the neutral brake cannot be used.

-The trigger switch function operates the trigger as a switch.

The trigger point can be selected and mixing, engine cut, and other functions can be turned on and off.

Function

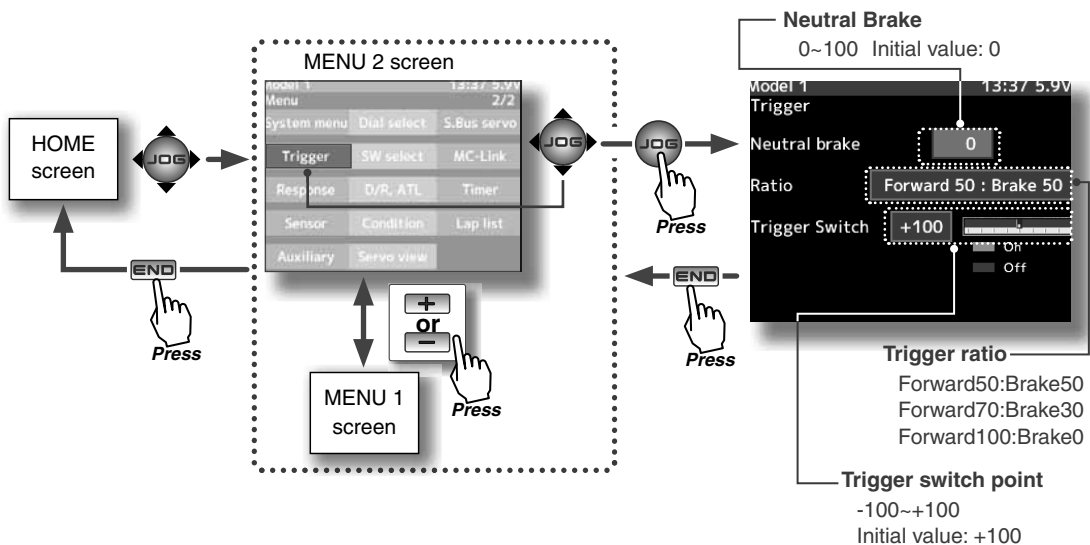

Neutral Brake function adjustment

(Preparation)

- Use the function select switch function to select the switch. (p.99)

1 (Neutral brake rate)

Select the setting item "Neutral brake" by (JOG) button up or down operation. Use the (+) and (-) buttons to set the neutral brake rate.



Adjust button

- Adjust with the (+) and (-) buttons.
- Return to the initial value "100" by pressing the (+) and (-) buttons simultaneously for about 1 second.

Neutral Brake

0~100
Initial value: 0

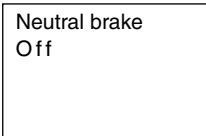
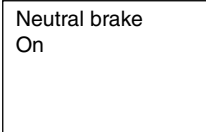

Neutral brake ON/OFF is displayed by pop-up window in the home screen.

2 When ending setting, return to the menu screen by pressing the (END) button.

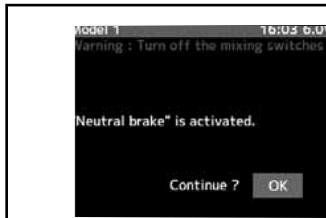

Warning display

If the power switch is turned on while the neutral brake switch is on, an audible alarm will be heard. Immediately set the neutral brake switch to OFF.

Reference

The ESC neutral brake function and T4PX neutral brake function can be used simultaneously. However, when setting is difficult to understand, we recommend that only one neutral brake function be used.

Dial / Trim Setting

When the neutral brake function is "ON", the neutral brake rate adjustment is automatically assigned to the throttle trim (DT1~DT6 or DL1).

Effect of set value of other functions on neutral brake

Throttle side EPA function, or ATL function setting also affects neutral brake side operation.

The Idle-up (p.69) or Engine Cut (p.71) function has priority.

Selecting the trigger ratio

1 (Throttle mode selection)

Select the setting item "Ratio" by (JOG) button up or down operation.

Select "Forward 50:Brake 50", "Forward 70:Brake 30" or "Forward 100:Brake 0" by (+) or (-) button.

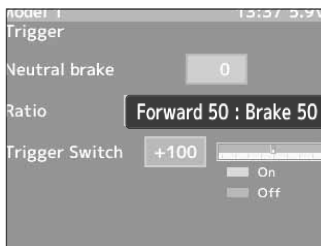

Setting buttons

- Use the (+) and (-) buttons to make adjustments.

Forward50:Brake50

Forward70:Brake30

Forward100:Brake0

2 When ending setting, return to the menu screen by pressing the (END) button.

Trigger switch setting method

(Preparation)

-This function is the switch select function (p.99) and sets the functions used at switch TS.

-The standard is trigger high direction ON. When set to ON by brake direction, the direction is set to reverse at the switch setup screen.

1 (Trigger switch ON/OFF point setting)

Select the setting item trigger switch by (JOG) button up or down operation.

Set the ON/OFF switching point by (+) and (-) button.

The ON/OFF switching point can also be set by holding the trigger in the position to be set as the ON/OFF switching point and pressing the (JOG) button. Fine adjustment is possible by (+) and (-) button.

The red part of the bar graph is the ON direction.

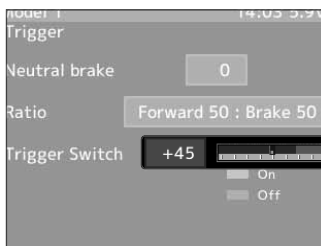

Adjustment buttons

- Use the (+) and (-) buttons to make adjustments.

Trigger switch point

-100~+100

Initial value: +100

2 When ending setting, return to the menu screen by pressing the (END) button.

This is a function select switch function. The idle-up function switch must be set. (p.99)

It is used to improve engine starting performance by raising the idling speed when the engine of a gasoline car (boat) is started.

This function is also effective when you want to prevent braking when the power was turned off during running due to the effect of gear ratio setting and the motor used with a motor car. However, when using the MC960CR, MC950CR, MC851C, MC602C, MC402CR, etc., check the ESC neutral position and set the idling function switch to ON after the set enters the operation mode, the same as the neutral brake function (p.66).

Operation

The throttle neutral position is offset to the forward side or brake side. There is no linkage locking, etc. because there is no change near the maximum operation angle even when the neutral position is offset by this function.

Operation Display

The **IDL** display appears on the home screen.

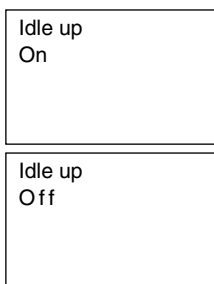
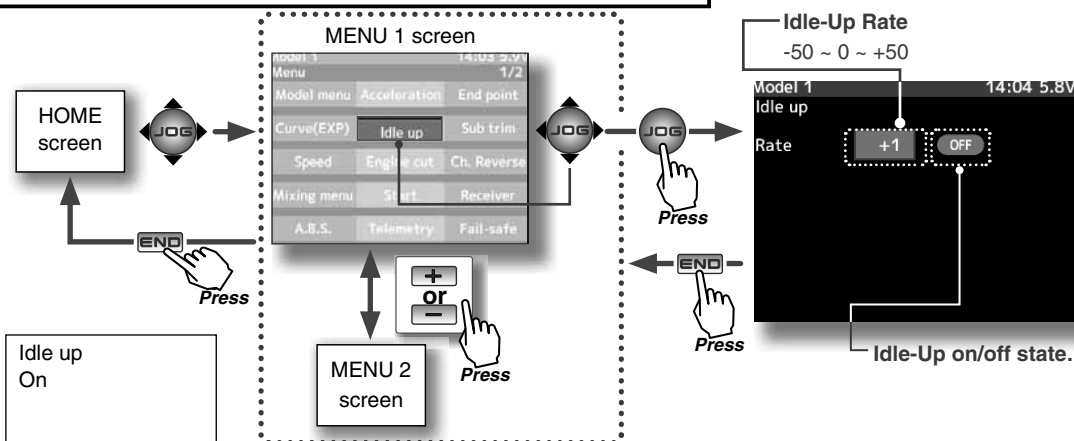

Idle up ON/OFF is displayed by pop-up window in the home screen.

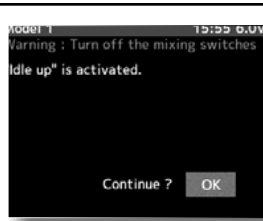

If the power switch is turned on while the idle-up switch is on, an audible alarm will be heard. Immediately set the Idle-Up switch to OFF.

Idle-Up function adjustment

(Preparation)

- Use the function select switch function to select the switch. (p.99)

1 (Idle-Up rate)

Use the (+) and (-) buttons to set the Idle-Up rate.

2 When ending setting, return to the menu screen by pressing the (END) button.

Adjust button

- Adjust with the (+) and (-) buttons.
- Return to the initial value "0" by pressing the (+) and (-) buttons simultaneously for about 1 second.

Idle-Up rate

- 50 ~ 0 ~ +50
- "-": Brake side
- "+": Forward side
- Initial value: 0%

Start Function

(Throttle system)

If the track is slippery and you begin to accelerate by pushing the trigger to full throttle, the car wheels will spin and the car will not accelerate smoothly. When the Start function is activated, merely operating the throttle trigger slowly causes the throttle servo to automatically switch from the set throttle position to a preset point so that the tires do not lose their grip and the car accelerates smoothly.

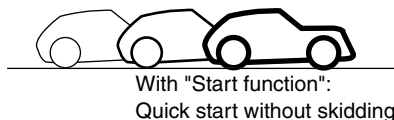

Start Function Operation

- When the throttle trigger is moved to the preset position (trigger point), the throttle servo moves to the preset position.
- When the throttle trigger is operated slowly so that the wheels will not spin, the car automatically accelerates to the set speed.
- This function is effective only for the first throttle trigger operation at starting. This function has to be activated before every start.
- When the throttle trigger is returned slightly, the Start function is automatically deactivated and the set returns to normal throttle trigger operation.

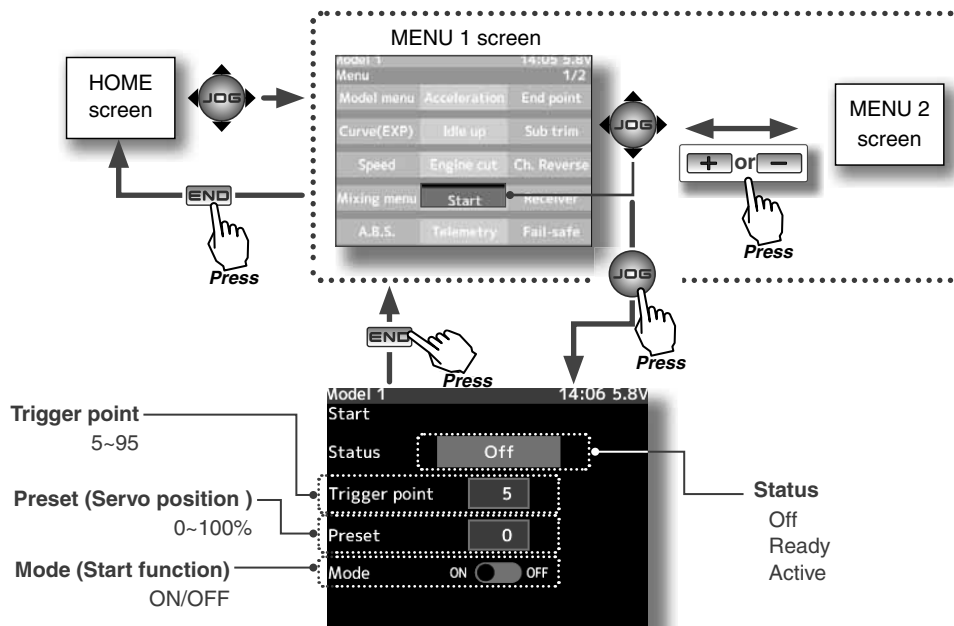

Function

Start function adjustment

(Preparation)

- Select the setting item "Mode" by (JOG) button up or down operation. Press the (+) or (-) button and select "ON".
- Select setup item "Trigger point" and make the following adjustments.



1 (Throttle position setup)

Set the throttle position by pressing the (+) or (-) button.

2 (Preset position setup)

Select the setting item "Preset" by (JOG) button up or down operation, and use the (+) and (-) buttons to set the preset position of the throttle servo.

"0" :Neutral
"F0" ~ "F100":Forward side

Setting Example: (When ESC used with an electric car)

Set the preset position to F75% at EPA100%.

3 ("Ready" setting)

Select the setting item "Status" by (JOG) button up or down operation, and press the (JOG) buttons simultaneously for about 1 second. "Ready" on the screen and the system enters the "Ready" state. Throttle trigger operation starts the function.

Setup item selection

- Select by (JOG) button up or down operation.

Adjust button

- Adjust with the (+) and (-) buttons.
- Return to the initial value by pressing the (+) and (-) buttons simultaneously (approx. 1 sec).

Trigger point

5 ~ 95
Initial value: 5

Preset position

0, F1 ~ F100
Initial value: 0

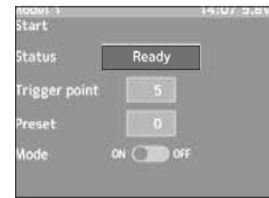

4 When ending setting, return to the menu screen by pressing the (END) button

-If the throttle trigger is moved to the set position while "Ready" on the screen, the throttle servo will move to the set position. The throttle operation wait state is reset when the throttle trigger is returned.

-When using the Start function, always set the function by performing step 3 above each time.

Engine Cut

(Throttle system)

When the switch is pressed, the throttle servo will move to the preset position without regard to the throttle trigger position. This is convenient when used to cut the engine of boats, etc. (The function select switch function. See page 99)

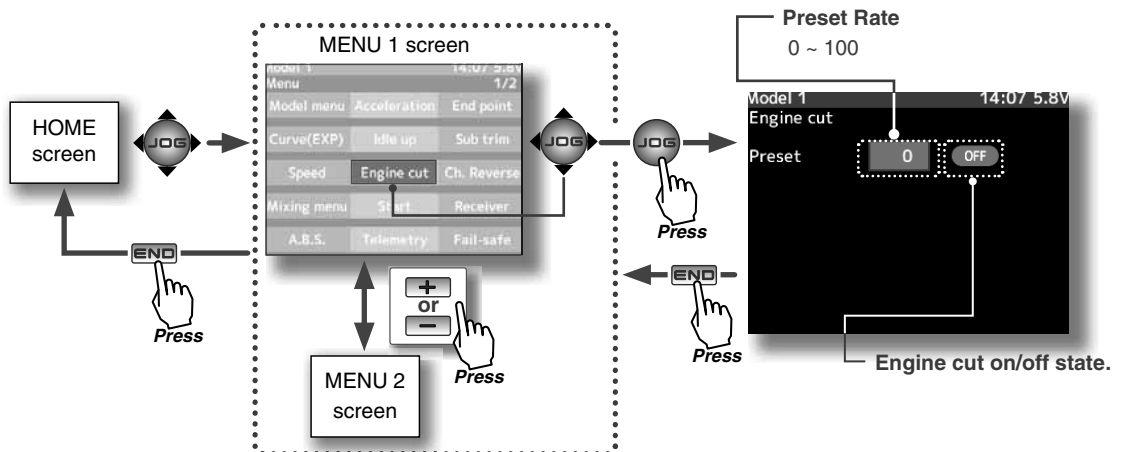

Start Function/ Engine Cut

Engine Cut function adjustment

(Preparation)

- This is a function select switch function. The engine cut function switch must be set. (p.99)
- The engine cut is turned on with the set switch.

1 (Preset position setup)

Use the (+) and (-) buttons to set the preset position of the throttle servo.

- "B100" ~ "B1" :Brake side
- "0" :Neutral
- "F1" ~ "F100" :Forward side



When engine cut is active, ON is displayed.

Adjust button

- Adjust with the (+) and (-) buttons.
- Return to the initial value "0" by pressing the (+) and (-) buttons simultaneously for about 1 second.

Preset rate

0 ~ 100
Initial value: 0%

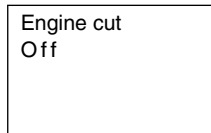
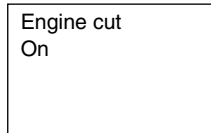

Engine cut up ON/OFF is displayed by pop-up window in the home screen.

2 When ending setting, return to the menu screen by pressing the (END) button.

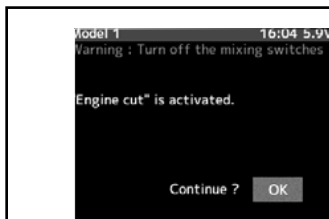

Warning display

If the power switch is turned on while the preset (engine cut) switch is on, an audible alarm will be heard. Immediately set the preset switch to OFF.

When trigger ratio was set to 100:0

When the trigger ratio (p.66) was set to 100:0, the brake function does not operate. The preset position set here becomes the linkage standard. The linkage is set so that the carburetor is fully closed and the engine is stopped within the preset adjustment range. The full throttle position is set by "Forward" of the end point function. The idling position is adjusted by throttle trim.

The throttle servo operating position (preset position) set by this setting is unrelated to the setting of other functions. Maximum to minimum servo travel can be set. However, the reverse function setting is enabled.

⚠ Caution

- ① Always operate carefully before using this function.

While push switch PS1-PS5, or trigger switch TS with preset function set is in the ON state, the servo (motor controller) is locked in the preset position and does not operate even if the throttle trigger is operated. If the servo was operated at the wrong setting, you may lose control of the car (boat).

A.B.S. Function

(Throttle system)

When the brakes are applied while cornering with a 4 Wheel Drive or other type of vehicle, understeer may occur. The generation of understeer can be eliminated and corners can be smoothly cleared by using this function.

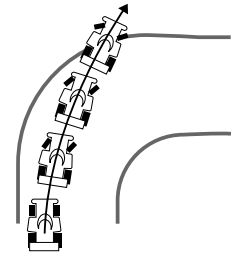

Without A.B.S.

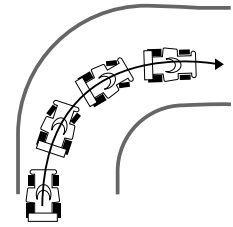

With A.B.S.

Operation

- When the brakes are applied, the throttle servo will pulse intermittently. This will have the same effect as pumping the brakes in a full size car.
- The brake return amount, pulse cycle, and brake duty can be adjusted.
- The region over which the ABS is effective can be set according to the steering operation. (Mixing function)

Operation display

The **ABS** display appears on the home screen.

When trigger ratio was set to 100:0

When trigger ratio (p.66) was set to 100:0, brake operation stops, and the servo does not operate even if the ABS function is set.

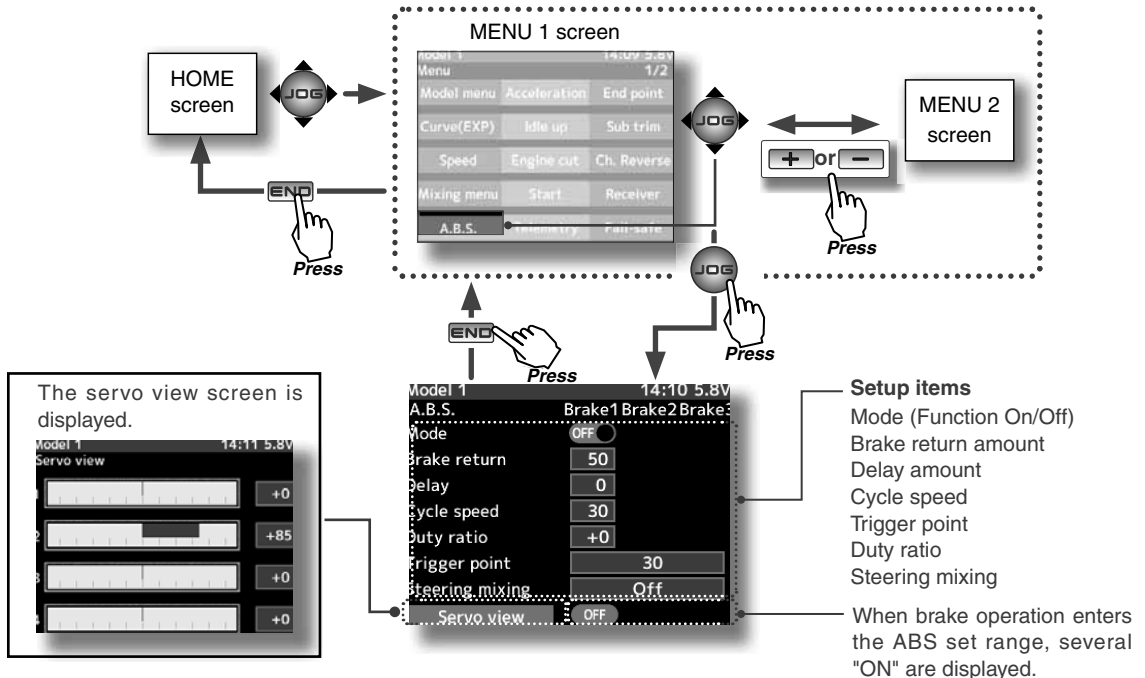

Function

- Mode : Function ON/OFF

ABS function ON/OFF setting. When using the ABS function, set to "ON".

- Brake return

Sets the rate at which the servo returns versus trigger operation for brake release. When set to 0%, the ABS function is not performed. When set to 50%, the servo returns 50% (1/2) of the trigger operation amount and when set to 100%, the servo returns to the neutral position.

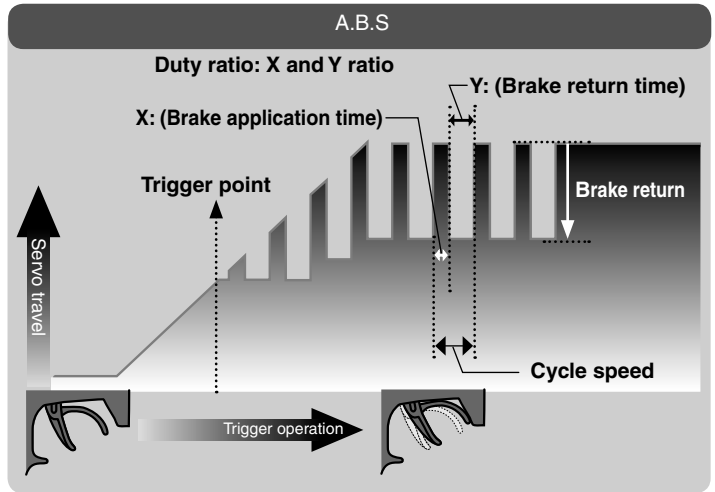

- Delay

Sets the delay from brake operation to ABS operation. When set to 0%, the ABS function is activated without any delay. At 50%, the ABS function is activated after a delay of approximately 0.7 second and at 100%, the ABS function is activated after a delay of approximately 1.4 seconds.

- Cycle speed

Sets the pulse speed (cycle speed). The smaller the set value, the faster the pulse cycle.

- Duty ratio

Sets the proportion of the time the brakes are applied and the time the brakes are released by pulse operation. The ratio can be set to +3 ~ 0 ~ -3 in 7 steps.

- Trigger point

Sets the trigger point at which the ABS function begins to operate at brake operation.

- Steering mixing

Sets ABS operation ON/OFF according to the steering operation range.

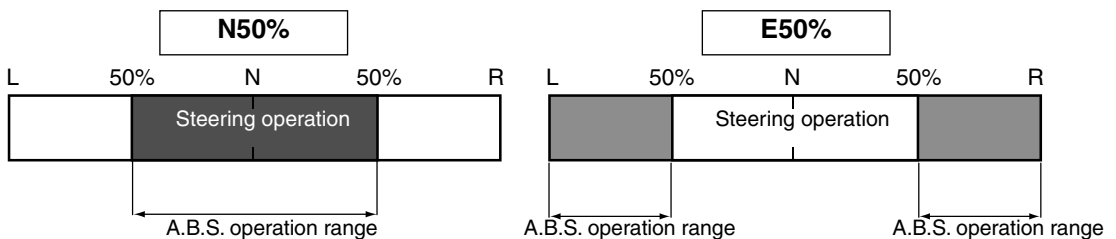

A.B.S Function

A.B.S. function adjustment

1 (Function ON/OFF)

Select the setting item "Mode" by (JOG) button up, down, left or right operation. Set the function to the active state by pressing the (+) or (-) button.

"OFF" :Function OFF
"ON" :Function ON

Setup item selection

- Select by (JOG) button up, down, left or right operation.

Adjustment buttons

- Use the (+) and (-) buttons to make adjustments.
- Return to the initial value by pressing the (+) and (-) buttons simultaneously (approx. 1 sec).

Function ON/OFF (Mode)
ON,OFF

2 (Brake return amount adjustment)

Select the setting item "Brake return" by (JOG) button up, down, left or right operation. Use the (+) or (-) button to adjust the return amount.

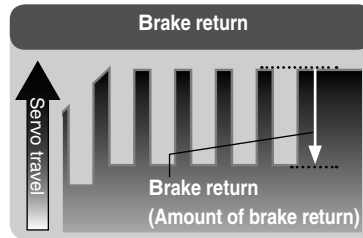

"0" :No return
"50" :Return to the 50% position of the brake operation amount
"100" :Return to the neutral position.

Return amount

0 ~ 50 ~ 100
Initial value: 50

- Brake return amount is influenced by the "EXP" rate on the brake side.

3 (Delay amount setup)

Select the setting item "Delay" by (JOG) button up, down, left or right operation. Use the (+) or (-) button to adjust the delay amount.

"0" :A.B.S. function performed without any delay
"50" :A.B.S function performed after an approximate 0.7 sec delay.
"100" :A.B.S. function performed after an approximate 1.7 secs delay.

Delay amount

0 ~ 100
Initial value: 0

4 (Cycle speed adjustment)

Select setting item "Cycle speed" by (JOG) button up, down, left or right operation. Use the (+) or (-) button to adjust the pulse speed (cycle).

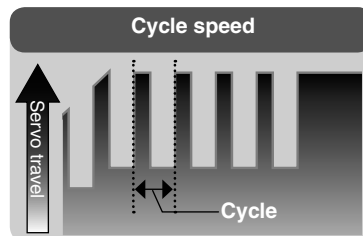

- The smaller the set value, the faster the pulse speed.

Cycle speed

1 ~ 100
Initial value: 10

5 (Trigger point setup)

Select setting item "Trigger point" by (JOG) button up, down, left or right operation. Use the (+) or (-) button to adjust the operation point.

- Sets the throttle trigger position at which the A.B.S. function is performed. The number is the % display with the full brake position made 100.

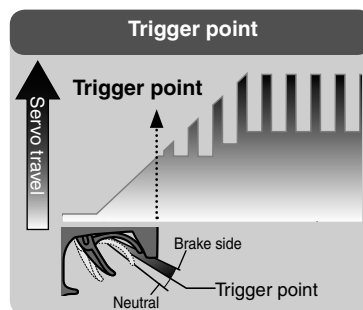

Trigger point

5 ~ 95
Initial value: 30

6 (Cycle duty ratio setup)

Select setting item "Duty ratio" by (JOG) button up, down, left or right operation. Use the (+) or (-) button to adjust the duty ratio.

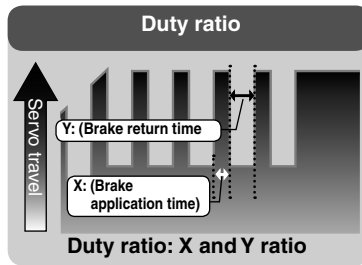

Duty ratio

-4 ~ 0 ~ +4
Initial value: 0

"-3" :Brake application time becomes shortest. (Brakes lock with difficulty)

"+3" :Brake application time becomes longest (Brakes lock easily)

(Remark) For low grip, set at the - side and for high grip, set at the + side.

7 (Steering mixing setup)

Select setting item "Steering mixing" by (JOG) button up, down, left or right operation. Use the (+) or (-) button to adjust the steering mixing range.

- Sets the range within which the A.B.S. function is performed relative to steering wheel operation.

Steering mixing

Off,
Neutral10 ~ 100,
End point10 ~ 100
Initial value: OFF

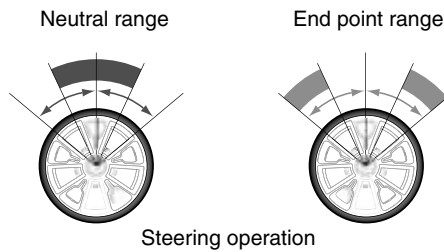

8 When ending setting, return to the initial screen by pressing the (END) button twice (for function menu screen, press the (END) button once).

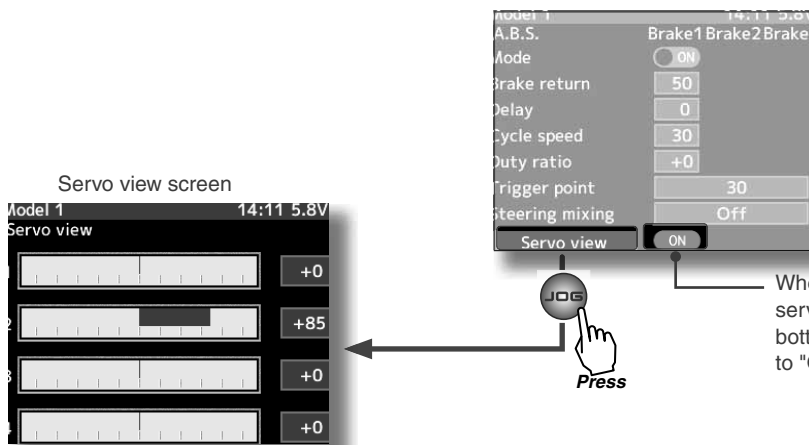

9 When ending setting, return to the menu screen by pressing the (END) button.

1/5 scale car and other independent brakes and ABS

ABS can be independently set for the brakes which are controlled by the Brake2 and Brake3 (3rd CH and 4th CH) by using the brake mixing function described on page 80.

Setting items other than trigger point and steering mixing can be adjusted independently.

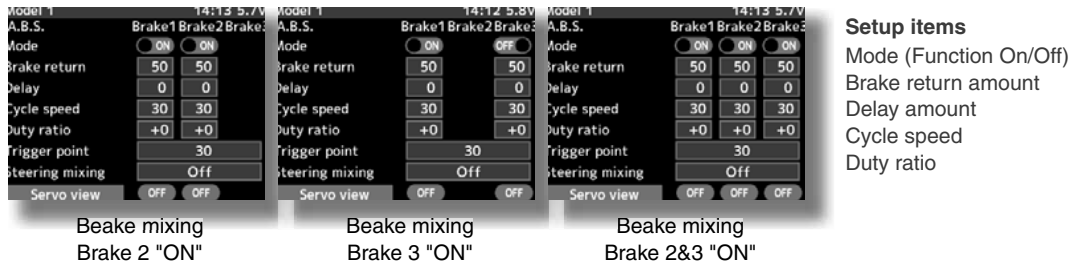

Switch setting

Use PS1~PS5 to switch the A.B.S. function ON/OFF.
 See the function select switch function. (p.99)

Dial / Trim Setting

The brake return amount, delay amount and cycle speed can be controlled with digital trim DT1~DT5 or digital dial DL1 etc. with the function select dial function. (p.101)

Example of A.B.S. function setting when S9353HV used (There will be a slight difference depending on the state of the linkage.)

- Basic setting
 Brake return: Approx. 30% (If this value is too high, the braking distance will increase.)
 Cycle speed: 5~7
 Duty ratio: 0 (When grip is low: - side, when grip is high: + side)
 Delay : 10~15%
 Trigger point: Approx. 70%
 Steering mixing: Off

- When the wheels lock, or the car spins, when the brakes are applied fully
 Brake return: Increase from 30%
 Duty ratio: Shift from 0 to - side (-1, -2, -3) →
 Delay : Reduce the delay

- When the braking effect is poor and the braking distance is long when the brakes are applied fully
 Brake return: Decrease from 30%
 Duty ratio: Shift from 0 to + side (+1, +2, +3) →
 DLY: Increase the delay

Big cars such as 1/5 scale GP car, etc. brake mixing, 4-wheel steering 4WS mixing used with Corolla, etc., dual ESC mixing that controls the front and rear motors independently, gyro mixing that allows adjustment of the sensitivity of Futaba car rate gyros, CPS mixing that controls Futaba channel power switch CPS-1, and other special mixing functions and program mixing that allows free setting among channels can be set at the mixing menu.

Program, mixing

These functions allow you to apply mixing between the steering, throttle, channel 3 and channel 4.

Steering mixing

This mixing function uses 2 servos to individually control the left and right steering. Left and right steering can be set independently so smooth cornering is possible.

Brake mixing

This function is used when the front and rear brakes must be adjusted independently such as a 1/5 scale GP car.

Gyro mixing

This function is a remote gain function that uses the 3rd or 4th CH of the transmitter to adjust the sensitivity of a Futaba car rate gyro. It can also be used by switching the two gains mode by switch. Normal mode and AVCS mode are explained at gyro mixing.

4WS mixing

This function can be used with Corolla and other 4WS type vehicles. It is mixing that uses the 1st CH to control the front side steering and the 3rd or 4th CH to control the rear side steering. OFF (front side only), reverse phase, same phase, rear side only and other 4WS types are switched by switch.

Dual ESC mixing

This function is mixing that uses the 2nd CH to control the front side motor controller and the 3rd or 4th CH to control the rear side motor controller of a Corolla or other 4WD type vehicle. Drive is switched among front side only, rear side only, and both front side and rear side (4WD) by switch.

CPS mixing

This function controls the Futaba CPS-1 channel power switch.

Normally, when a CPS-1 unit is used to light the chassis dress-up and other illumination (LED) the LED is connected to a vacant switch channel of the connected CPS-1 unit and the LED is turned on and off by switch while the vehicle is running. However, when this CPS mixing function is used the LED can be turned on and off and also flashed in step with steering and throttle operation, as well as being turned on and off by switch.

Tilt mixing

Tilt mixing uses an outboard engine and applies bidirectional mixing from rudder (steering) to flap and from flap to rudder so that with a boat, rudder operation and tilt mixing operation can be performed by 2 servos.

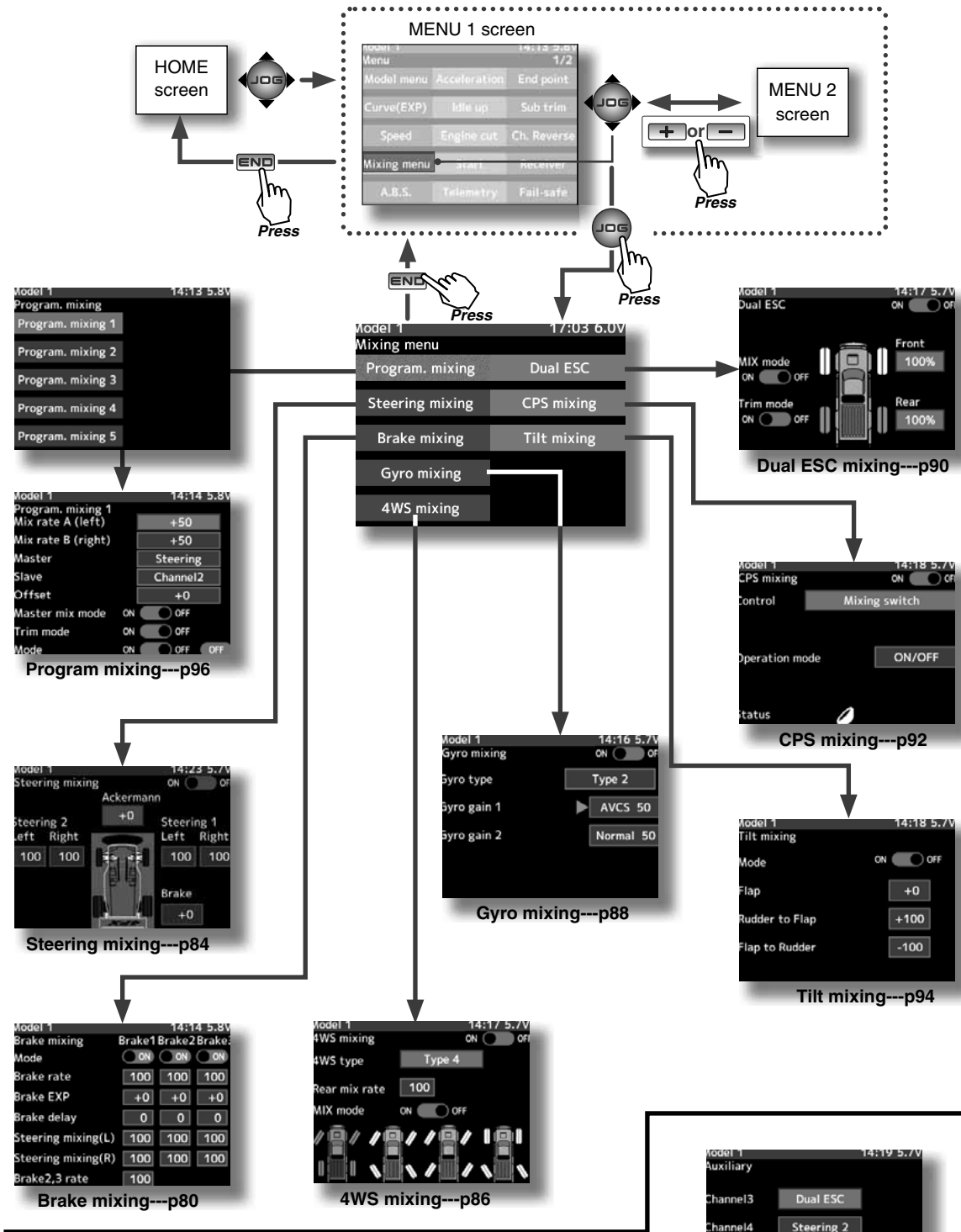

Since the mixing function can be assigned to CH3 and CH4, all mixings cannot be used simultaneously. Since program mixing is free, it can be used even when other mixings are active, but they interact.

The mixing used can be confirmed on the Auxiliary screen. (p.155)

Function

Brake Mixing

(Throttle, 3rd, 4th channel system)

This function is used when the front and rear brakes must be adjusted independently such as a 1/5 scale GP car. This mixing uses the 2nd CH for the rear brakes and the 3rd or 4th CH for the front brakes, or controls the front brakes with the 3rd CH and 4th CH servos, or controls the 2nd CH by independent throttle and controls the rear and front brakes with the 3rd CH and 4th CH. In addition, mixing which varies the 3rd CH and 4th CH brake rate in proportion to steering operation is also possible.

The mixing function is assigned to CH3 and CH4. Channels used by other mixing cannot be used. When the number of channels is insufficient, cancel the other mixing.

When trigger ratio was set to 100:0

When the throttle mode (P66) was set to 100:0, brake operation stops. When using brake mixing, set the throttle mode to 70:30 or 50:50.

Operation

- When braking, mixing is applied to 2nd CH→3rd CH, 4th CH.
- 3rd CH and 4th CH brake amount, 2nd CH, 3rd CH, and 4th CH brake delay, and 3rd CH and 4th CH brake EXP and ABS can be set.
- Steering mixing which varies front brakes 3rd CH and 4th CH matched to the steering operation can be set. Front brakes 3rd CH and 4th CH can be individually weakened according to the steering left or right operation amount.

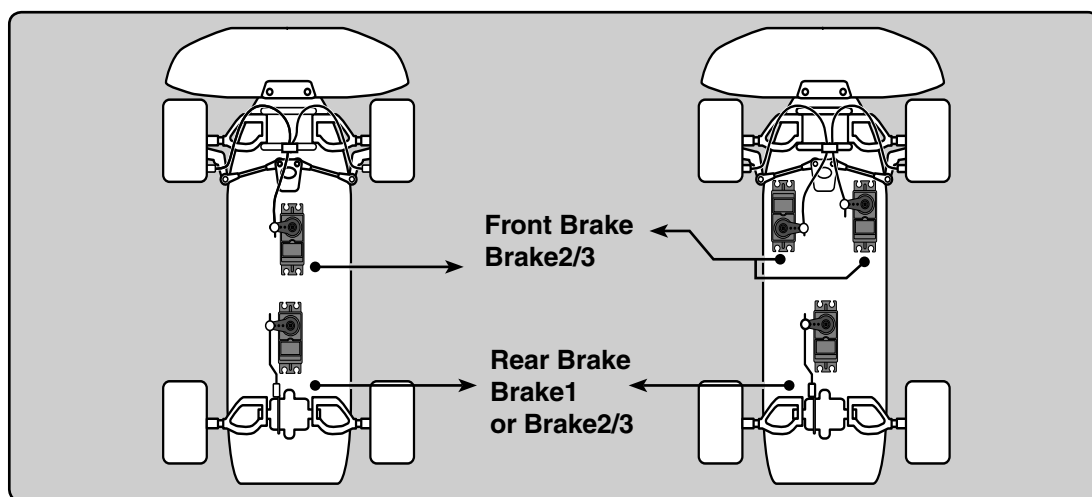

3rd, 4th channels A.B.S.

Brakes 2 and 3 can also use the ABS function (p.73) by brake mixing. All setting items other than trigger point and steering mixing can be set for front brake 2 and 3 use only. Brake 2 and 3 can also use the ABS function independently even when the brake 1 (CH2) ABS function is OFF. The ABS (brake 2 and 3) function can be set ON/OFF by switch function. (p.99)

Brake mixing screen from mixing menu screen (p.79)

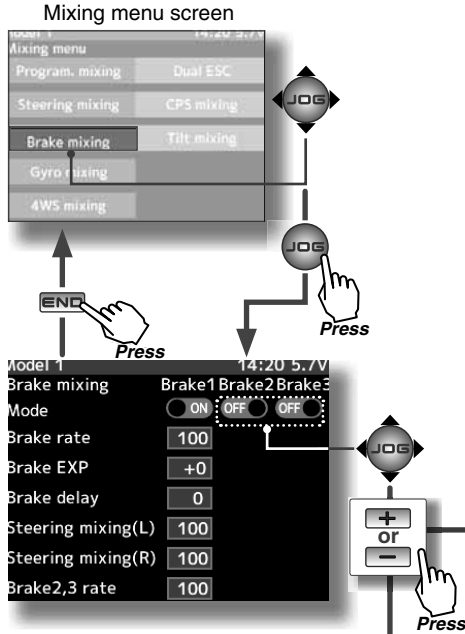

When channels 3 and 4 are used by other mixing, the message "No assignable channel" is displayed.



When the brake 2 or 3 mixing mode is set to "ON", the brake 2 or 3 channel setup screen is displayed.

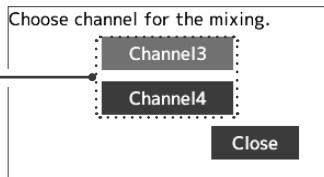

Channel is selected by (JOG) button operation.



The mixing used can be confirmed on the Auxiliary screen. (p.155)

Brake mixing ON

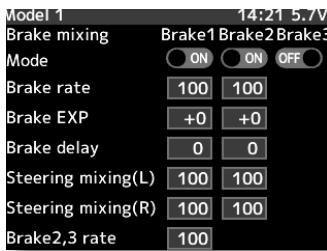

Brake 2 ON

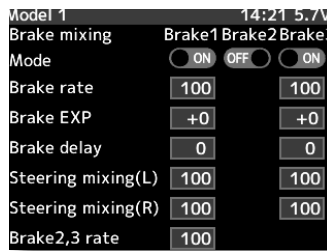

Brake 3 ON

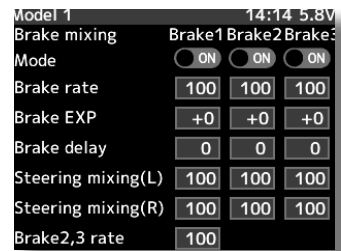

Brake 2 & 3 ON

Brake mixing adjustment

1 (Function ON/OFF)

Select the setting items "Mode Brake2" or "Mode Brake3" by (JOG) button up, down, left or right operation. Set the function to the active state by pressing the (+) or (-) button.

"OFF" :Function OFF
"ON" :Function ON

Setting buttons

- Use the (+) and (-) buttons to make adjustments.

Function ON/OFF (Mode)

ON, OFF

2 (Select channel)

The screen that sets the channel used by brake 2 or brake 3 is displayed. Select channel 3 or channel 4 by (JOG) button up or down operation, and press the (JOG) button.

If channels 3 and 4 are used by other mixing, the message "No assignable channel" is displayed. Set the other mixing to "OFF". The mixing used can be checked at the auxiliary channel screen. (p.155)

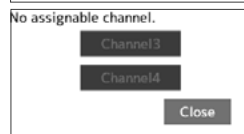
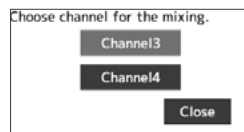

3 (Brake 2 & 3 rate)

Select setup items "Brake2 rate" or "Brake3 rate" by (JOG) button up, down, left or right operation, and use the (+) and (-) buttons to adjust the Brake rate amount.



- When adjusting the brake amount of both brakes after individually adjusting the Brake2 and Brake3, select "Brake2,3 rate".

-The brake 1 rate is linked with throttle channel (ATL) setting.

Adjustment buttons

- Use the (+) and (-) buttons to make adjustments.

- Return to the initial value by pressing the (+) and (-) buttons simultaneously (approx. 1 sec).

Brake rate

0 ~ 100
Initial value:100

4 (Brake 2 & 3 -EXP)

With the jog dial, move the blinking cursor up/down, left or right to select "Brake2 -EXP or Brake3 -EXP". Use the plus (+) button to adjust for a faster brake response or use the minus (-) button for a slower or milder brake response.



-When using Brake2 and Brake3 servos as front brakes and using EXP, set the Brake2-EXP amount and Brake3- EXP amount separately.

-Brake 1 EXP is linked with throttle curve (brake EXP) setting.

Adjustment buttons

- Use the (+) and (-) buttons to make adjustments.

- Return to the initial value by pressing the (+) and (-) buttons simultaneously (approx. 1 sec).

Brake EXP rate

-100 ~ 0 ~ +100%
Initial value:0

5 (Delay amount setup)

Select setup items "Brake1" Delay or Brake2,3 -Delay" by (JOG) button up, down, left or right operation, and use the (+) and (-) buttons to adjust the delay amount.

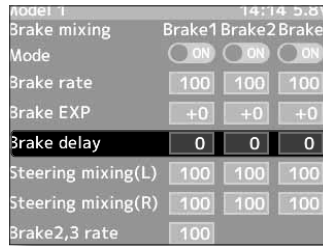

- Since a delay at all the brakes is dangerous, a delay is not applied to the brake to be adjusted last.

For example, when brakes 1, 2, and 3 are all used, when a delay is applied to brakes 2 and 3, a delay cannot be applied to brake 1. When a delay must be applied to brake 1, the brake 2 or brake 2 delay must be set to "0".

Adjustment buttons

- Use the (+) and (-) buttons to make adjustments.
- Return to the initial value by pressing the (+) and (-) buttons simultaneously (approx. 1 sec).

Delay amount

100 ~ 0
Initial value:0

6 (Steering mixing)

Use this function when you want to weaken the brakes when steering was operated.

Select the setting item "Steering mixing(L)" or "Steering mixing(R)" by (JOG) button up, down, left, or right operation. Use the (+) or (-) button to adjust the brake amount.

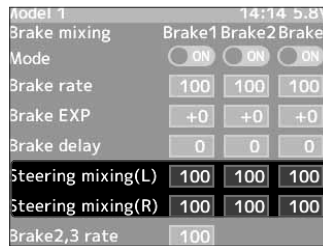

Use "Steering mixing(R)" Brake1,2,3 to adjust the brake amount relative to the steering right operation amount. and "Steering mixing(L)" Brake1,2,3 to adjust the brake amount relative to the steering left operation amount. The smaller the value, the weaker the front brakes. Set value "100" is the state in which steering mixing is not performed.

- The mixing amount can be adjusted in a range from 0 to 100.

Adjustment buttons

- Use the (+) and (-) buttons to make adjustments.
- Return to the initial value by pressing the (+) and (-) buttons simultaneously (approx. 1 sec).

Brake rate

Steering mixing(L)

Steering mixing(R)

0 ~ 100
Initial value:100

7 When ending setting, return to the Mixing menu screen by pressing the (END) button.

Dial / Trim Setting

The function select dial function can control the brake 1,2,3 rate, delay amount and EXP setting using digital dial or digital trim. (p.101)

Steering Mixing

(Steering, 3rd or 4th channel system)

This mixing function uses 2 servos to individually control the left and right steering. Left and right steering can be set independently so smooth cornering is possible.

The right side steering servo or the left side steering servo connects to receiver CH1 and the other side connects to receiver CH3 or CH4. The channel to which the left and right servo connects is not specified. After the left and right servos are adjusted individually, Ackerman can also be adjusted by Ackerman rate.

In addition, the left and right steering are operated in the opposite direction by switch. An emergency brake function by steering can also be set.

The mixing function is assigned to CH3 and CH4. Channels used by other mixing cannot be used. When the number of channels is insufficient, cancel the other mixing.

Steering mixing screen from mixing menu screen (p.79)

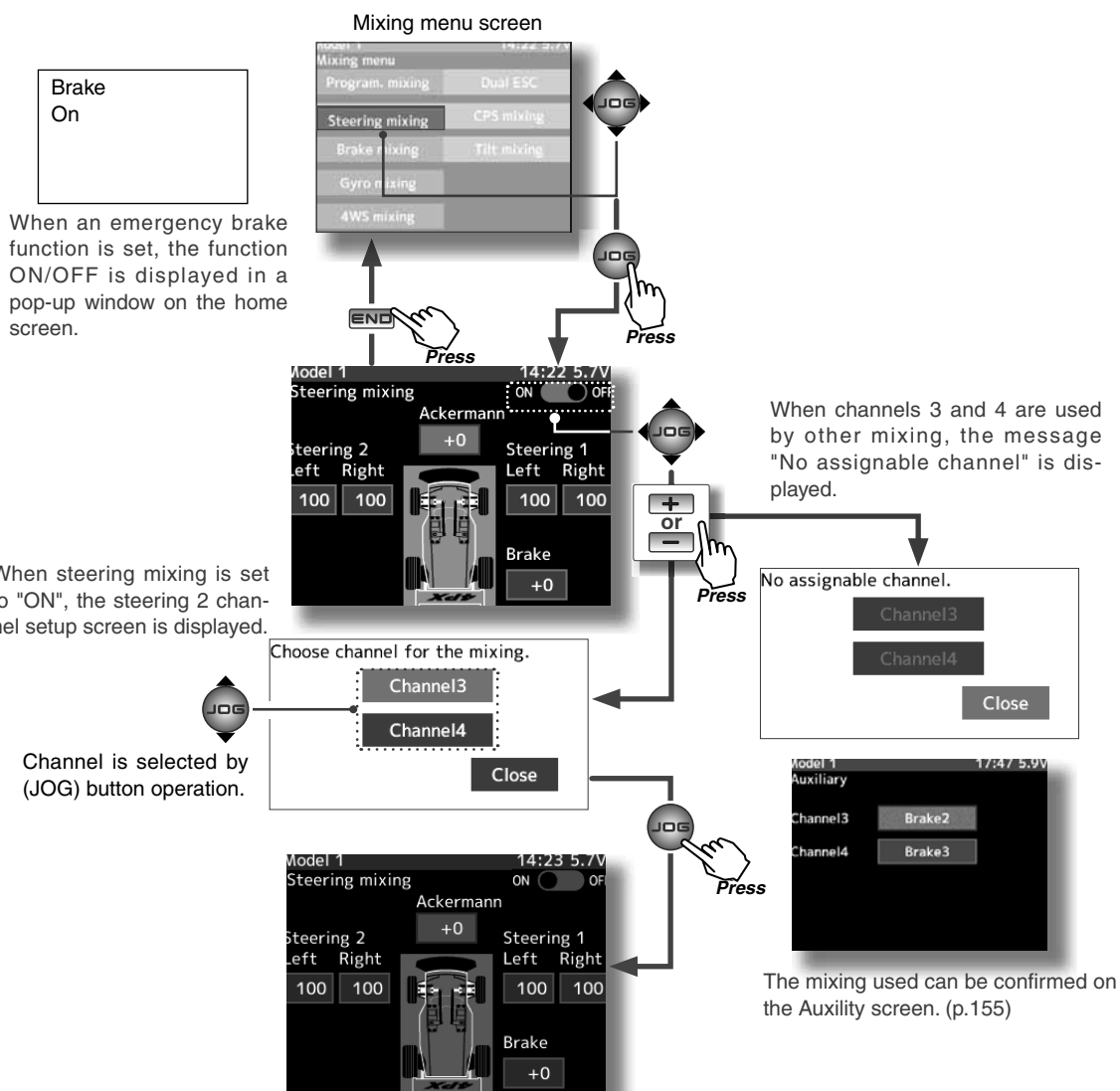

Function

Steering mixing adjustment

1 (Function ON/OFF)

Select the setting items "ON-OFF" by (JOG) button up, down, left or right operation. Set the function to the active state by pressing the (+) or (-) button.

"OFF" :Function OFF
 "ON" :Function ON

2 (Channel setup)

A screen at which the channel to be used by steering 2 is displayed. Select channel 3 or channel 4 connected to a servo during preparation by (JOG) button up or down operation, and press the (JOG) button.

- If channels 3 and 4 are used by another mixing, the message "No assignable channel" is displayed. Set the other mixing to OFF. Mixing can be checked at the auxiliary channel screen. (P155)

3 (Steering 1 and receiver CH1 servo steering angle adjustment)

Select the steering 1 left or right "Rate" by (JOG) up, down, left, or right operation.

Turn the steering wheel fully to the left or right and adjust the left and right steering amounts by (+) or (-) button.

4 (Steering 2 and receiver CH3 or 4 servo steering angle adjustment)

Select steering 2 left or right "Rate" by (JOG) button up, down, left, or right operation.

Turn the steering wheel fully to the left and right and adjust the left and right steering amounts by (+) and (-) button.

5 (Ackerman adjustment)

Select the Ackerman "Rate" by (JOG) button up, down, left, or right operation.

Adjust the left and right differential amount and adjust the Ackerman by (+) and (-) button.

6 (Emergency brake)

(Preparations)

·When using this function, set the switch with the Switch Select function. (p.99)

Select the emergency brake "Rate" by (JOG) button up, down, left, or right operation. Adjust the steering 1/2 operation position by (+) and (-) button.

7 When ending setting, return to the Mixing menu screen by pressing the (END) button.

Setting buttons

- Use the (+) and (-) buttons to make adjustments.

Function ON/OFF

ON, OFF

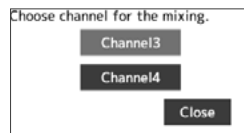

Left / Right rate

0~100 Initial value:100



Ackermann rate

-100~0~+100 Initial value:100



Brake rate

-100~0~+100 Initial value:100

4WS Mixing

(Steering, 3rd or 4th channel system)

This function can be used with crawlers and other 4WS type vehicles. It is mixing that uses the 1st CH to control front side steering and the 3rd CH to control rear side steering.

OFF (front side only), reverse phase, same phase, rear side only, and other 4WS type switching is used by selecting PS1, PS2, PS4 or PS5 with the function select function (p.99).

The mixing function is assigned to CH3 and CH4. Channels used by other mixing cannot be used. When the number of channels is insufficient, cancel the other mixing.

4WS mixing screen from mixing menu screen (p.79)

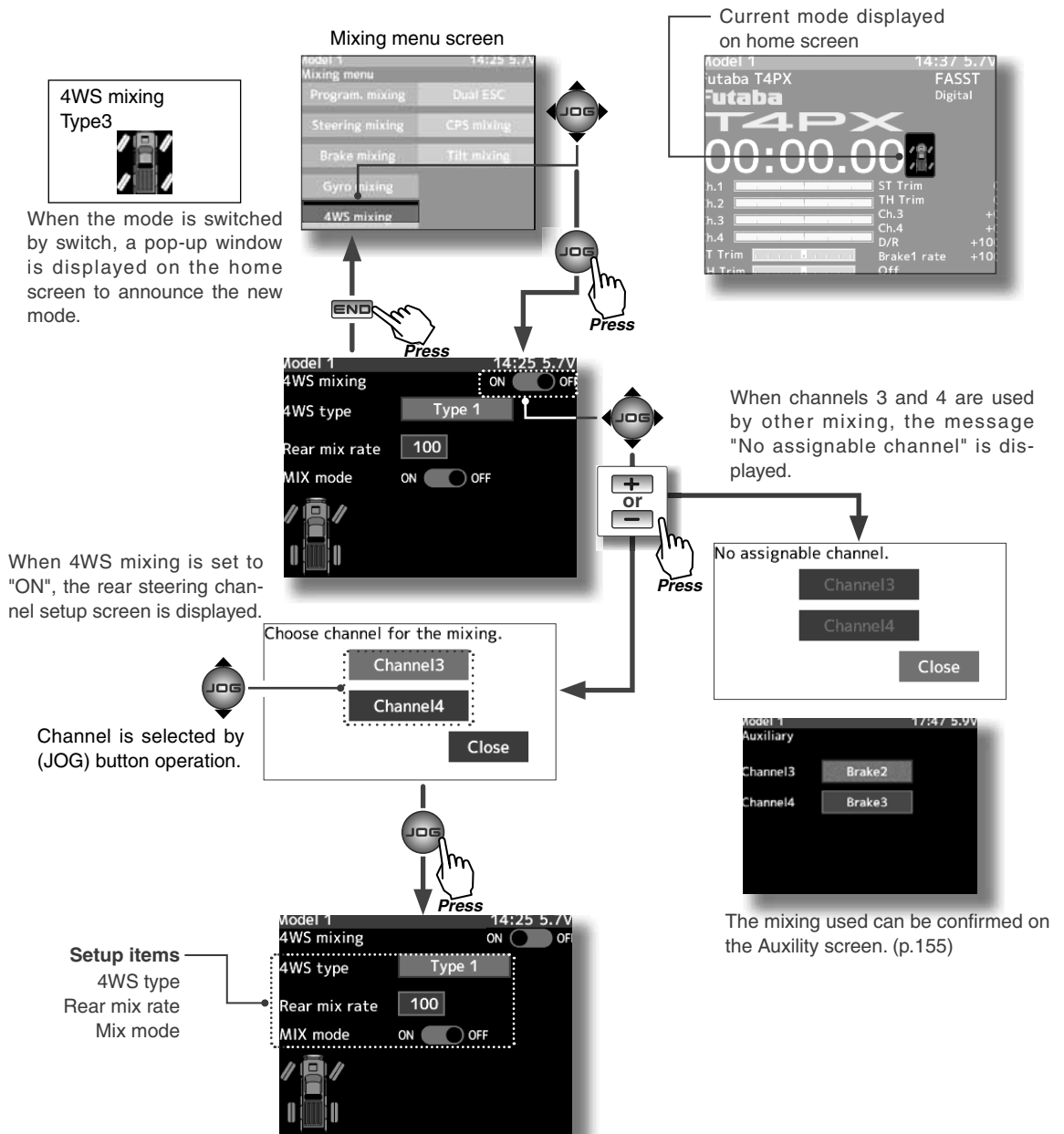

Function

4WS mixing adjustment

(Preparation)

- Since this function is used by switching the type of 4WS with a switch, the switch used by the function select switch function (p.99) is set.

1 (4WS mixing function ON/OFF and channel setup)

Refer to the left page and set the function to ON and set the mixing channel.

2 (4WS type selection)

Operate the (JOG) button up and down and select the setting item "4WS type". Select the type by pressing the (+) or (-) button.

"Type1" :Function OFF (front only)

"Type2" :Front side only, reverse phase switching

"Type3" :Front side only, reverse phase and same phase switching

"Type4" :Front side only, reverse phase, same phase, and rear side only switching

Setting buttons

- Use the (+) and (-) buttons to make adjustments.

Function ON/OFF (4WS type)

Type1(OFF), Type2,
Type3, Type4

Switched in the order shown in the figure below by set SW

Type2

Front side only, Reverse phase switching

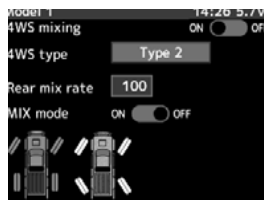

Type3

Front side only, Reverse phase and same phase switching

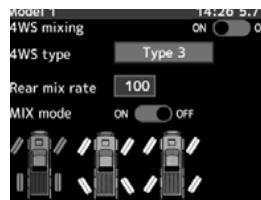

Type4

Front side only, reverse phase, same phase, and rear side only switching

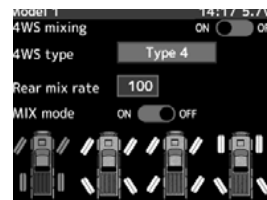

3 (Rear side travel adjustment)

Operate the (JOG) button up and down and select setting item "Rear mix rate". Adjust the rear side travel with the (+) or (-) button.

Adjustment buttons

- Use the (+) and (-) buttons to make adjustments.
- Return to the initial value by pressing the (+) and (-) buttons simultaneously (approx. 1 sec).

Rear rate (Rear mix rate)

0 ~ 100

Initial value:100

4 (Mix mode setting)

Operate the (JOG) button up and down and select the setting item "MX mode". Set the mix mode with the (+) or (-) button.

"OFF" :The EXP function of the 1st CH and other settings are not mixed.

"ON" :The EXP function of the 1st CH and other settings are mixed.

Setting buttons

- Use the (+) and (-) buttons to make adjustments.

Mixing mode (MX Mode)

OFF, ON

Initial value: OFF

5 When ending setting, return to the Mixing menu screen by pressing the (END) button.

Dial / Trim Setting

The mixing amount can be adjusted by using the function dial function. (p.101)

This function is a remote gain function which adjusts the sensitivity of the Futaba car rate gyro at the T4PX side, and is mixing that uses the 3rd or 4th CH to adjust the gyro sensitivity. When using the T4PX by switching the AVCS and normal modes use PS1- PS5 with the function select switch function (p.99).

For a description of the car rate gyro mounting method and handling, refer to the rate gyro instruction manual.

The mixing function is assigned to CH3 and CH4. Channels used by other mixing cannot be used. When the number of channels is insufficient, cancel the other mixing.

Gyro mixing screen from mixing menu screen (p.79)

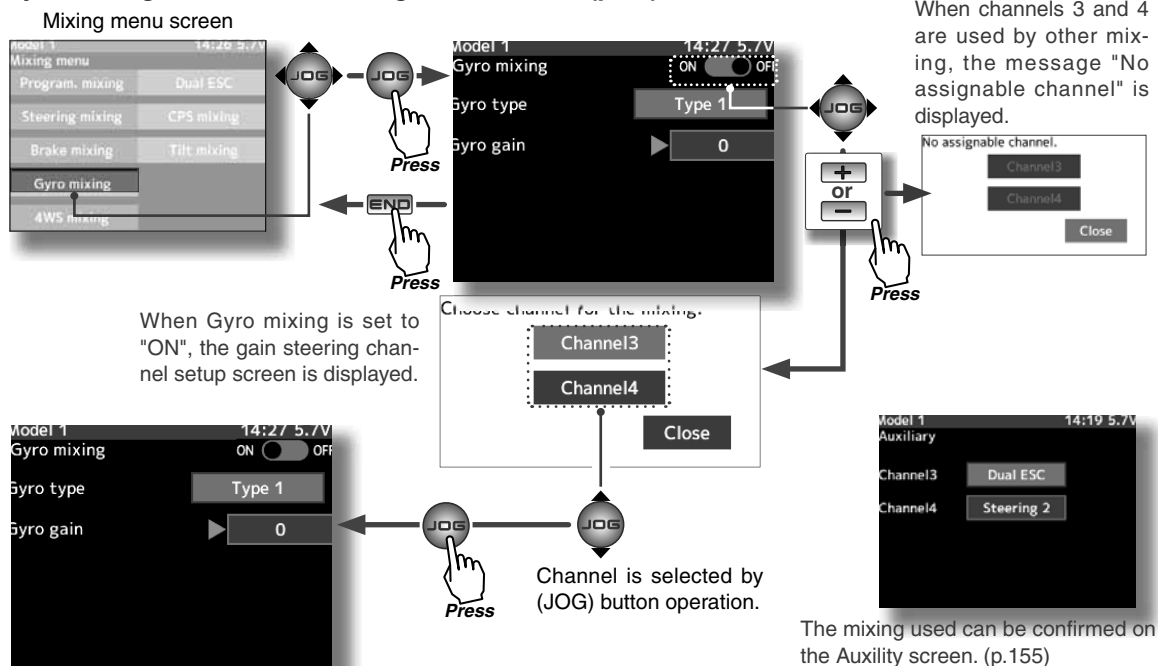

AVCS / NORMAL Modes

The gyro has 2 operating modes: NORMAL mode and AVCS mode. In the AVCS mode, the angle is controlled simultaneously with NORMAL mode rate control (swing speed). The AVCS mode increases straight running stability more than that of the NORMAL mode. Because the feel of operation is different, choose your favorite mode.

NORMAL

Countersteers against outside force, but cannot correct the skid direction.

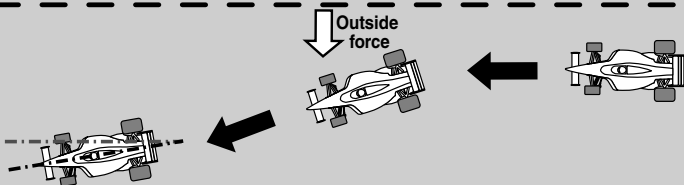

AVCS

Corrects the skidding direction and forcefully maintains the heading.

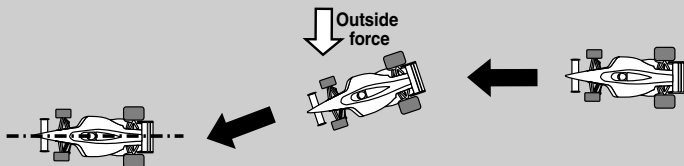

Gyro mixing adjustment

(Preparation)

- Refer to the gyro instruction manual and connect the gyro to the receiver. When using remote gain, connect gyro sensitivity adjustment to the 3rd or 4th CH of the receiver.
- When using gyro mixing by switching between the NORM (normal) and AVCS modes, use the function select switch function (p.99) to set the switch to be used.

1 (Gyro mixing function ON/OFF and channel setup)

Refer to the left page and set the function to ON and set the mixing channel.

2 (Gyro mixing type selection)

Operate the (JOG) button up and down and select the setting item "Gyro type". Select the type by pressing the (+) or (-) button.

"Type1" :One mode only
"Type2" :Switching Gyro gain 1 and Gyro gain 2

Setting buttons

- Use the (+) and (-) buttons to make adjustments.

Gyro tyoe

Type1, Type2
Initial value: Type1



Gyro mixing
AVCS:50

When the gain is switched by a switch, a pop-up window appears on the home screen to announce the gain.

Shows the gyro mode select switch mode.

3 (Gyro gain1 side gain adjustment)

Operate the (JOG) button up and down and select setting item "Gyro gain1". Adjust the Gyro gain1 side gain with the (+) or (-) button.

(Gyro gain2 side gain adjustment)

Operate the (JOG) button up and down and select setting item "Gyro gain2". Adjust the Gyro gain2 side gain with the (+) or (-) button.

Adjustment buttons

- Use the (+) and (-) buttons to make adjustments.
- Return to the initial value by pressing the (+) and (-) buttons simultaneously (approx. 1 sec).

Gain

AVCS120 ~ 0 ~ Normal120
Initial value:0

4 When ending setting, return to the Mixing menu screen by pressing the (END) button.

Dial / Trim Setting

The gain amount can be adjusted by using the function dial function. (p.101)

Dual ESC Mixing

(Throttle system)

This function is mixing used with crawlers and other 4WD type vehicles and uses the 2nd CH to control the rear motor controller and the 3rd or 4th CH to control the front motor controller.

Front drive only, rear drive only, and both front and rear drive (4WD) switching can be performed by trim dial or by setting a switch for each mode.

The mixing function is assigned to CH3 and CH4. Channels used by other mixing cannot be used. When the number of channels is insufficient, cancel the other mixing.

Dual ESC mixing screen from mixing menu screen (p.79)

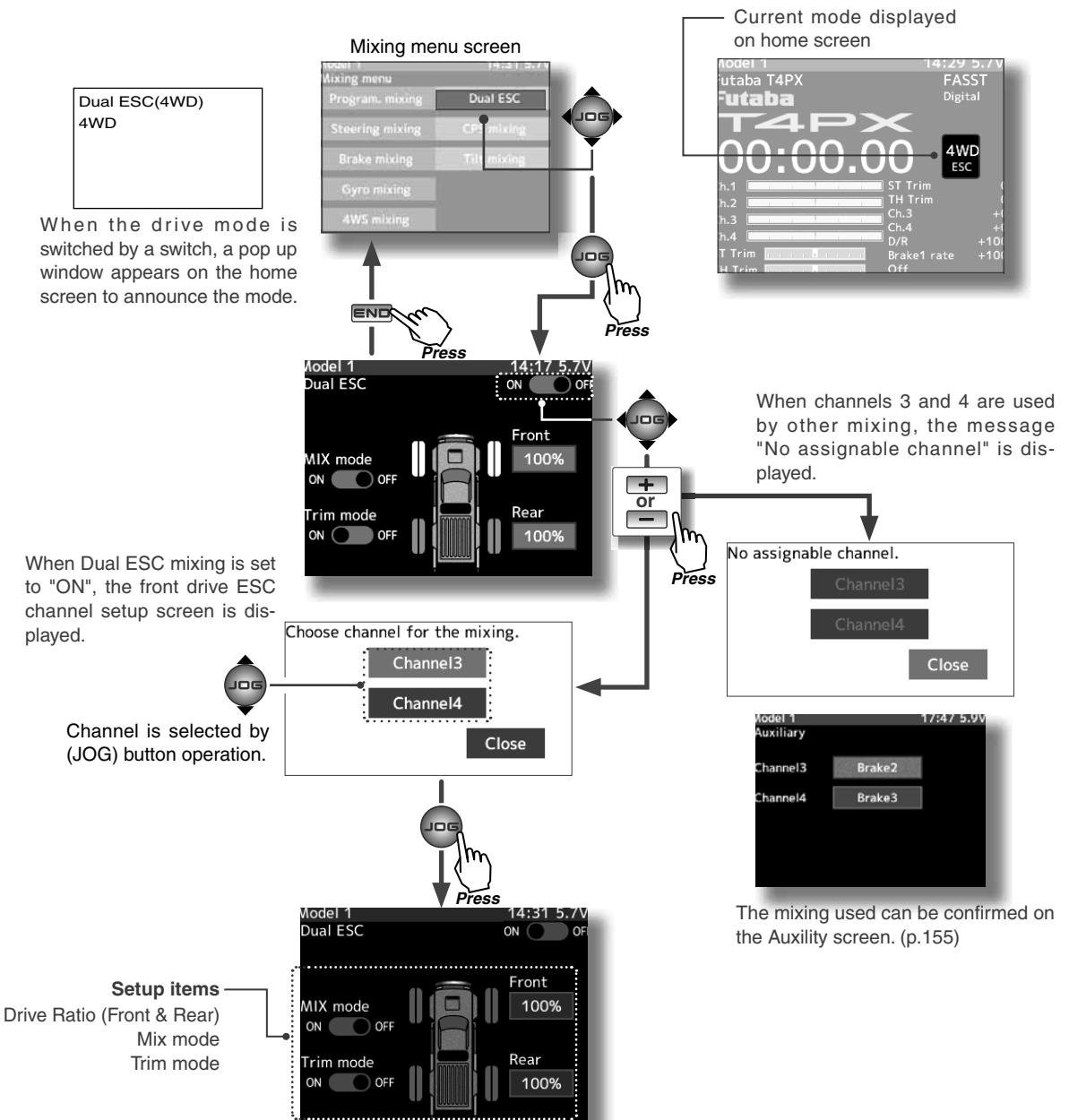

Function

Dual ESC mixing adjustment

(Preparation)

- This function has 2 methods. One method is used by switching the drive type (4WD/front/rear) by one digital trim/dial. The other method performs switching by assigning a switch to each mode (4WD/front/rear). Both methods are set from among DL1 and DT~1DT6 by dial select function. (P101)

1 (Dual ESC setting)

Refer to the left page and set the function to ON and set the mixing channel.

When switching by one digital trim is set, the set switch performs switching as shown below.

Front drive ⇔ 4WD ⇔ Rear drive

2 (Drive ratio adjustment)

Adjust the front and rear motor controller operation amount by (+) or (-) button.

The (+) button increases and the (-) button decreases the rear ratio.

Both the front and rear ratios become 100%

3 (Mix mode setting)

Operate the (JOG) button up and down and select the setting item "MIX mode". Set the mix mode with the (+) or (-) button.

"OFF" :The EXP function of the 2nd CH and other settings are not mixed.

"ON" :The EXP function of the 2nd CH and other settings are mixed.

4 (Trim mode setup)

Select setup item "Trim mode" by (JOG) button up, down, left, or right operation, and use the (+) or (-) button to select the mixing mode.

"OFF" :Trim of the 2nd CH is added.

"ON" :Trim of the 2nd CH is removed.

5 When ending setting, return to the Mixing menu screen by pressing the (END) button.

Trigger ratio Setting

Use a 50:50 trigger ratio setting. (P66)

Dial / Trim Setting

The function select dial function can control the drive ratio with digital dial or digital trim, using the function select dial function. (p.101)

Note:

As this function drives 2 separate motor controllers simultaneously, a mutual load is applied. Use this function carefully so that the motor controllers are not damaged.

Futaba will not be responsible for motor controller, motor, and other vehicle trouble due to use of this function.

Adjustment buttons

- Use the (+) and (-) buttons to make adjustments.
- Return to the initial value by pressing the (+) and (-) buttons simultaneously (approx. 1 sec).

Drive ratio

Front 0%:Rear 100%

~ Front 100%:Rear 0%

Initial value:

Front 100%:Rear 10 0%

Setting buttons

- Use the (+) and (-) buttons to make adjustments.

MIX mode

OFF, ON

Initial value: OFF

Trim mode

OFF, ON

Initial value: OFF

CPS Mixing

This function controls the Futaba CPS-1 channel power switch.

Normally, when using the CPS-1 unit to light the vehicle dress-up and other illumination (LED) the CPS-1 unit with LED connected is connected to a vacant switch channel and the LEDs are turned on and off by switch while the vehicle is running. However, when the CPS mixing function is used, the LED can be turned on and off and flashed in step with steering and throttle operation, as well as being turned on and off by switch. The flashing speed (cycle) can also be set.

For instance, the LED can be flashed as a brake light by throttle brake side operation.

The mixing function is assigned to CH3 and CH4. Channels used by other mixing cannot be used. When the number of channels is insufficient, cancel the other mixing.

CPS mixing screen from mixing menu screen (p.79)

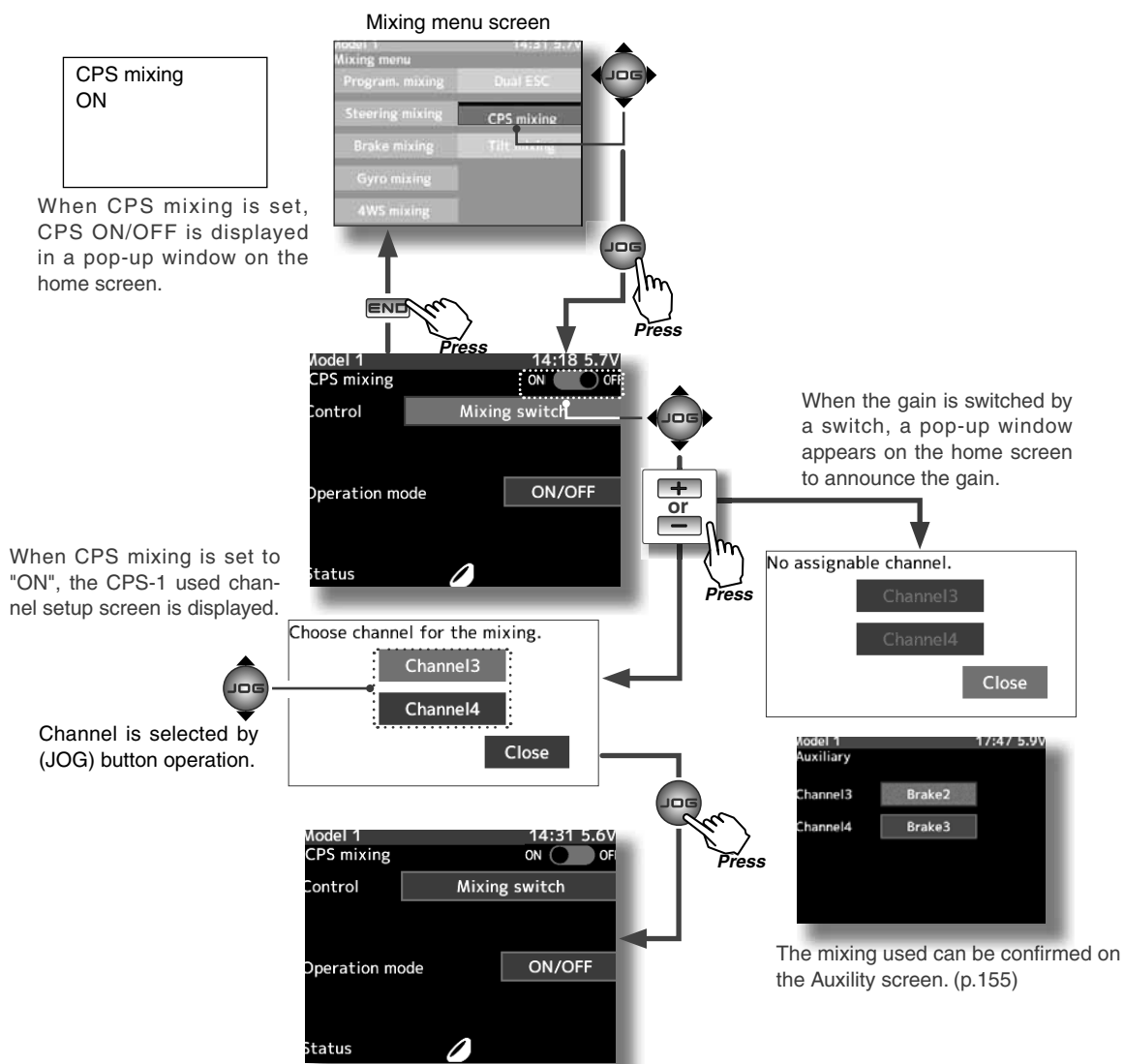

CPS-1 mixing adjustment

(Preparation)

- Refer to the left page and set the function to ON and set the mixing channel.
- CPS-1 connects to the receiver channel assigned to CPS mixing.
- When the LEDs are turned on and off by switch, use the function select switch function (P.99) to set the switch to be used.

1 (Control system setup)

Operate the (JOG) button up and down and select the setting item "Control".

Press the (+) or (-) button and select the function.

"Mixing Switch"	: ON/OFF by switch set at the 3rd or 4th CH
"Steering neutral"	: ON at steering neutral
"Steering endpoint"	: ON at both sides of steering
"Throttle neutral"	: ON at throttle neutral
"Throttle forward"	: ON at throttle forward side
"Throttle brake"	: ON at throttle back (brake) side
"Throttle neutral & brake"	: ON at throttle neutral and back (brake) sides

2 (ON/OFF switching position selection)

Operate the (JOG) button up and down and select the setting item "ON/OFF position".

Press the (+) or (-) button and select the ON/OFF position.

Since the ON/OFF state is displayed at the right side of the setting item "Status", setting can be confirmed while operating the function to be controlled (for example, throttle).

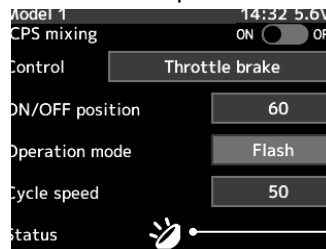

Adjustment buttons

- Use the (+) and (-) buttons to make adjustments.
- Return to the initial value by pressing the (+) and (-) buttons simultaneously (approx. 1 sec).

ON/OFF position

5 ~ 95
Initial value:50

3 (Operation mode setup)

Operate the (JOG) button up and down and select the setting item "Operation mode".

Press the (+) or (-) button and select the type of LED lighting.

Normal ON/Off type or flashing can be selected.

"ON/OFF"	: Normal ON/OFF type
"Flash"	: Flashing display

Setting buttons

- Use the (+) and (-) buttons to make adjustments.

Operation mode

ON/OFF, Flash

4 (Flashing cycle setting)

When flashing type "Flash" was selected at the setting item "Operation mode" the flashing speed (cycle) can be set.

Operate the (JOG) button up and down and select the setting item "Cycle speed".

Press the (+) or (-) button and select the flashing speed (cycle speed).

Adjustment buttons

- Use the (+) and (-) buttons to make adjustments.
- Return to the initial value by pressing the (+) and (-) buttons simultaneously (approx. 1 sec).

Cycle speed

1 ~ 100
Initial value:50

5 When ending setting, return to the Mixing menu screen by pressing the (END) button.

Tilt mixing uses an outboard engine and applies bidirectional mixing from rudder (steering) to flap and from flap to rudder so that with a boat, rudder operation and tilt mixing operation can be performed by 2 servos.

Tilt mixing can be performed by rudder operation, by steering wheel and flap channel.

The mixing function is assigned to CH3 and CH4. Channels used by other mixing cannot be used. When the number of channels is insufficient, cancel the other mixing.

Tilt mixing screen from mixing menu screen (p.79)

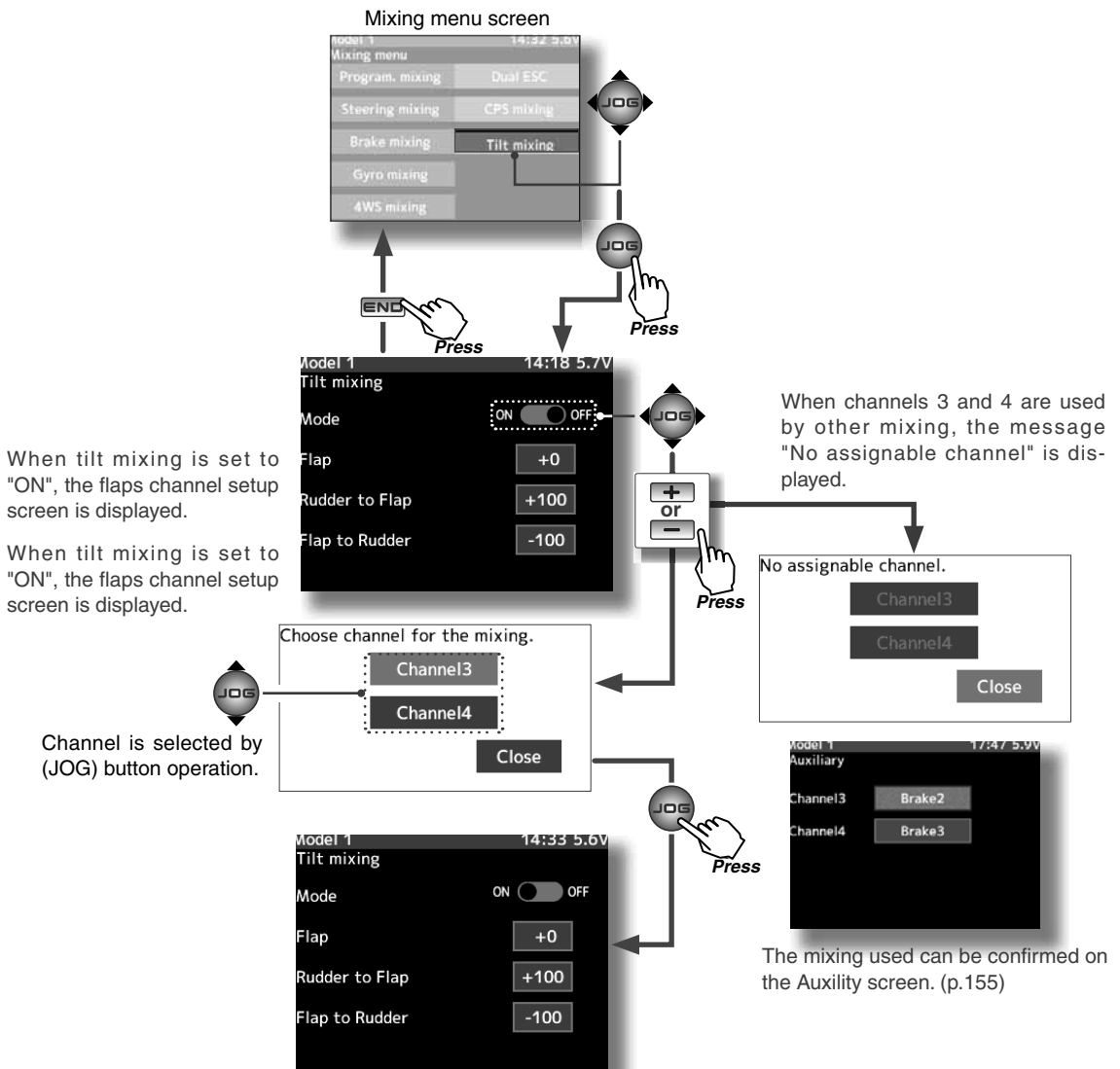

Tilt mixing adjustment

(Preparation)

- Use the function select dial function to select the flap channel operation dial. (p.101)

1 (Function ON/OFF)

Refer to the left page and turn on the function and set the mixing channel (flap).

2 (Flap rate check and adjustment)

Select the setting item "Flap" by (JOG) button up or down operation, and adjust the flaps by (+) or (-) operation.

3 (Rudder to Flap mixing amount adjustment)

Select setup item "Rudder to Flap" by (JOG) button up or down operation, and use the (+) and (-) buttons to adjust the mixing amount.

"+" :Operate in same direction as steering
"- " :Operate in opposite direction of steering

4 (Flap to Rudder mixing amount adjustment)

Select setup item "Flap to Rudder" by (JOG) button up or down operation, and use the (+) and (-) buttons to adjust the mixing amount.

"+" :Operate in same direction as channel 3
"- " :Operate in opposite direction of channel 3

5 When ending setting, return to the Mixing menu screen by pressing the (END) button.

Slave channel output (Initial value)

Rudder to Flap channel side	: +100%
Flap channel to Rudder side	: -100%

Dial / Trim Setting

The mixing rate amount can be controlled with digital dial or digital trim, using the function select dial function. (p.101)
--

Effect of the set value of other functions on tilt mixing

Steering end point function, curve function, speed function, or D/R function setup also effects flap channel operation. However, even if set, steering reverse function setup does not reverse the flap channel.
--

Setting buttons

- Use the (+) and (-) buttons to make adjustments.

Function ON/OFF (Mode)

ON, OFF

Adjustment buttons

- Use the (+) and (-) buttons to make adjustments.

- Return to the initial value by pressing the (+) and (-) buttons simultaneously (approx. 1 sec).

Flap rate

-100~+100

Initial value: 0

Mixing amount (Rudder to Flap)

-100~+100

Initial value: +100

Mixing amount (Rudder to Flap)

-100~+100

Initial value: +100

Program, Mixing (1, 2, 3, 4, 5)

(All channels)

These functions allow you to apply mixing between the steering, throttle, channel 3 and channel 4.

Additional Functions

- When the steering or throttle channel is the master channel (channel that applies mixing), trim data can be added. (Trim mode)
- The mixing mode selection. (Master mixing mode)
- The master channel mixing center point (point at which the direction changes) can be offset. (Offset function)

Movement of the slave channel side

The movement of the master channel side will be added to the movement of the slave channel side.

When trigger ratio was set to 100:0

When trigger ratio (p.66) was set to 100:0, brake operation stops. When the master channel (MST) was set to throttle, mixing operates only at the "Rate A (forward)" side. It does not operate at the "Rate B (brake)" side.

Other mixing functions are assigned to CH3 or CH4. Program mixing can use CH3 or CH4 regardless of the other mixing functions. However, be careful because they interact.

Program. mixing screen from mixing menu screen (p.79)

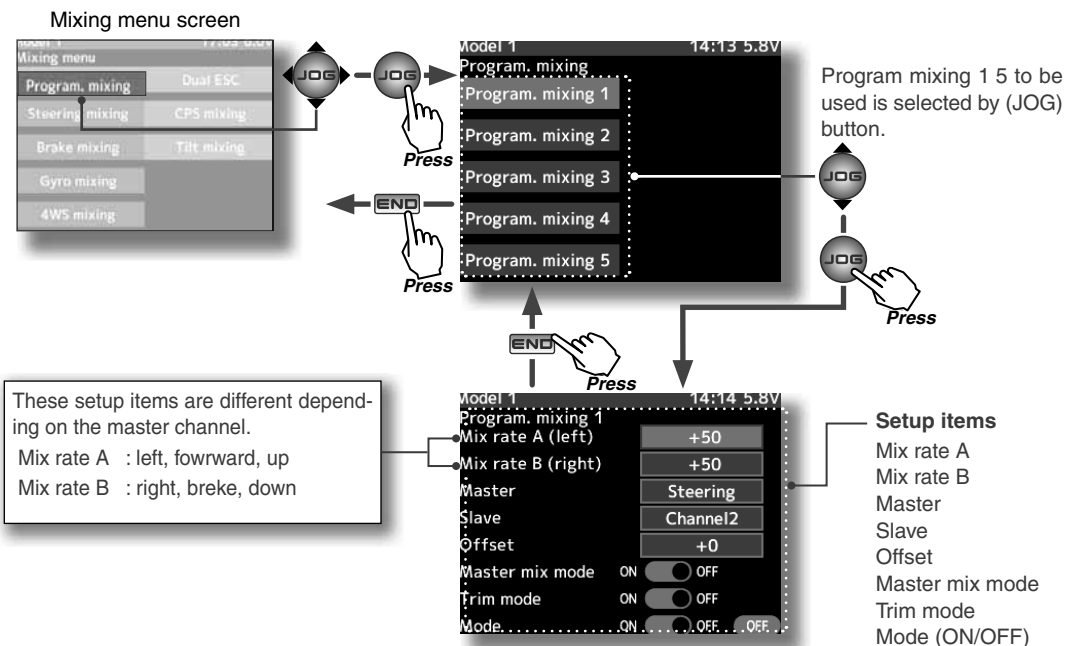

These setup items are different depending on the master channel.
Mix rate A : left, forward, up
Mix rate B : right, brake, down

Program mixing adjustment

(Preparation)

- Use the function select switch function (page 99) to select the switch. (as desired)
- Select the "Program mixing" by (JOG) button up or down operation, and select the 1 to 5 by pressing the (JOG) button.

1 (Mixing function ON/OFF)

Select the setting item "Mode" by (JOG) button up or down operation. Press the (+) or (-) button and set the function to the "ON" state.

"OFF" :Function OFF
"ON" :Function ON



Switch

Program mixing 1-5

Setup item selection

- Select by (JOG) button up or down operation.

Setting buttons

- Use the (+) and (-) buttons to make adjustments.

Function ON/OFF (Mode)

ON, OFF

When mixing is active, ON is displayed.

2 (Master channel)

Select setup item "Master" by (JOG) button up or down operation, and select the master channel by pressing the (+) or (-) button.

Setting buttons

- Use the (+) and (-) buttons to make adjustments.

Channel selection (Master)

Steering, Throttle
Channel3, Channel4

3 (Slave channel)

Select setup item "Slave" by (JOG) button up or down operation, and select the slave channel by pressing the (+) or (-) button.

Channel selection (Slave)

Channel1, Channel2
Channel3, Channel4

4 (Left, forward or up side mixing amount adjustment)

Select the setting item "left", "forward", or "up" by (JOG) button up or down operation. Use the (+) or (-) button and adjust the right, brake, or down side mixing amount.

Adjustment buttons

- Use the (+) and (-) buttons to make adjustments.
- Return to the initial value by pressing the (+) and (-) buttons simultaneously (approx. 1 sec).

5 (Right, brake or down side mixing amount adjustment)

Select the setting item "right", "brake", or "down" by (JOG) button up or down operation. Use the (+) or (-) button and adjust the right, brake, or down side mixing amount.

Mixing amount

-100~0~+100
Initial value: +50

6 (Offset amount setup)

Select setup item "Offset" by (JOG) button up or down operation, and use the (+) and (-) button to adjust the offset amount.

Adjustment buttons

- Use the (+) and (-) buttons to make adjustments.
- Return to the initial value by pressing the (+) and (-) buttons simultaneously (approx. 1 sec).

Offset amount

-100~0~+100
Initial value: 0

7 (Mixing mode setup)

Select setup item "Master mix mode" by (JOG) button up or down operation, and use the (+) and (-) button to adjust the offset amount. right operation, and use the (+) or (-) button to select the mixing mode.

Setting buttons

- Use the (+) and (-) buttons to make adjustments.

Master mix mode

ON, OFF

"OFF" :Mixing proportional to master channel operation.
"ON" :Mixing by master channel another function considered.

8 (Trim mode setup)

Select setup item "Trim mode" by (JOG) button up, down, left, or right operation, and use the (+) or (-) button to select the mixing mode.

"OFF" :Trim is added.
"ON" :Trim is removed.

Setting buttons

- Use the (+) and (-) buttons to make adjustments.

Trim mode

ON, OFF

9 When ending setting, return to the Mixing menu screen by pressing the (END) button.

When Steering and Throttle Travel is Insufficient

When the steering servo travel is insufficient even when D/R is 100% and Endpoint is 140%, programmable mixing can be used to increase the travel somewhat.

(Reference data)

- Program mixing(1 - 5)->ON
- Master channel -> Steering Mixing is applied from steering
- Slave channel ->Steering Mixing is applied to steering and the travel is increased.
- Mix rate A (left) -> 10% [When subtrim is centered (0%)]
- Mix rate B (right) -> 10% [When subtrim is centered (0%)]
- Offset -> 0% / - Master mix mode -> ON / - Trim mode -> OFF

However, the operating range of the servo is exceeded even if a large value is input at "Mix rate A (left)" and "Mix rate B (right)" and a zone over which the servo does not operate even when the wheel is moved to the left or right is created. A zone over which the servo does not operate is also generated at the moving side when the subtrim is moved to the left and right. Therefore, set the "Mix rate A (left)" and "Mix rate B (right)" value by checking servo operation.

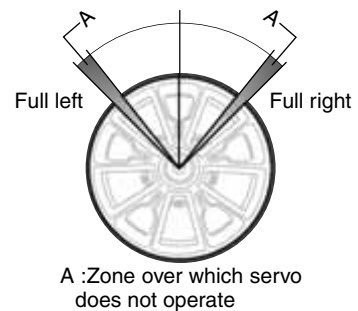

Switch Setting

Select the program mixing function ON/OFF switch with the function select switch function. (p.99)

Dial / Trim Setting

The mixing amount can be adjusted by using the function dial function. (p.101)

SW Select

This function allows selection of the function to be performed by the switches (PS1, PS2, PS3, PS4, PS5, throttle trigger) and setting of the direction, etc. of operation.

-The table in the next page lists the functions that can be assigned to each push switch.

-All switches can be made alternating operations (ON/OFF switched each time SW pressed). (NOR/ALT)

-The ON/OFF direction can be reversed. The reverse select function always starts from the ON state. However, the trigger switch is different, depending on the position. (NOR/REV)

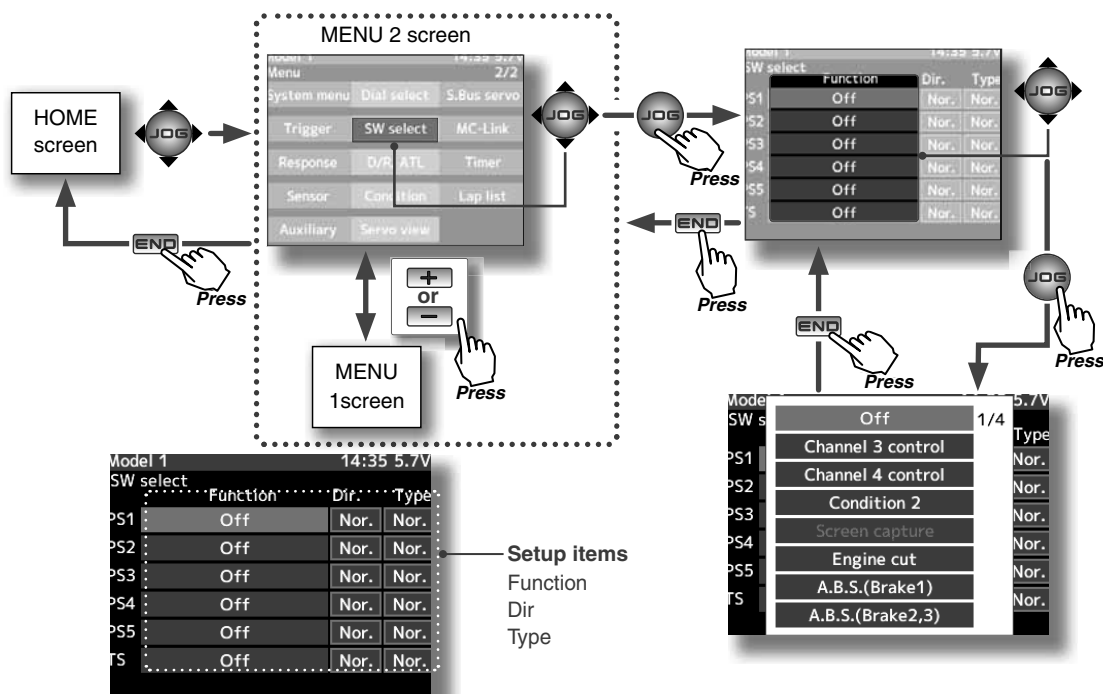

Function select switch setup

1 (Select switch selection)

Select "Function" of the switch you want to set by (JOG) button up, down, left, or right operation, and press the (JOG) switch.

2 (Function setup)

A function list is displayed. Select the desired function by (JOG) button up or down operation, and press the (JOG) button.

(Changing the operation direction)

Select "Dir" of the switch you want to set by (JOG) button up, down, left, or right operation, and switch the direction by (+) or (-) button.

(Changing the type of operation)

Select "Type" of the switch you want to set by (JOG) button up, down, left, or right operation and switch the type by (+) or (-) button.

Setup switch selection

- Select by (JOG) button up, down operation.

Setup buttons

- Use the (+) and (-) buttons to make adjustments.
- Press the (+) and (-) buttons simultaneously (approx. 1 sec) to return to the initial screen.

Initial value:
"OFF", "Nor", "Nor"

3 When ending setting, return to the menu screen by pressing the (END) button.

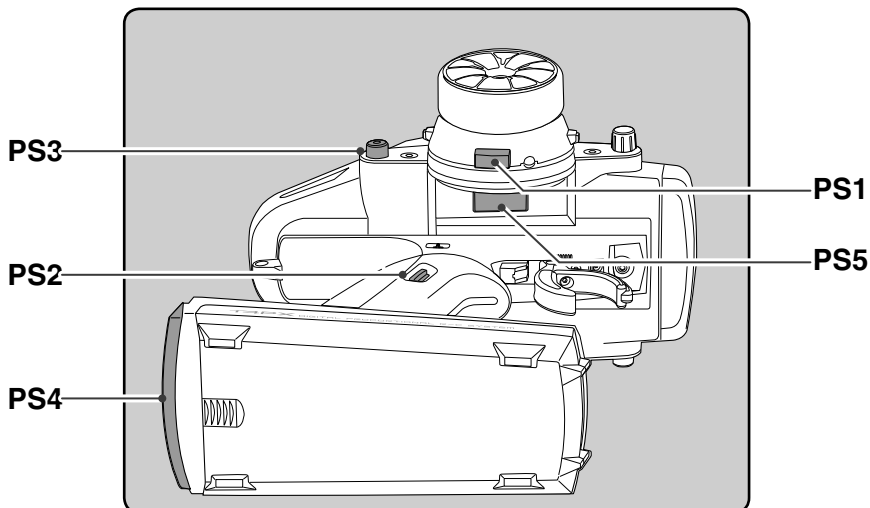

Set table functions (PS1/PS2/PS3/PS4/PS5) & Trigger switch (TS)

Abbreviation used on setup screen	Function name, etc
Channel 3 control	Operation of channel 3
Channel 4 control	Operation of channel 4
Condition 2	2nd condition function ON/OFF
Screen capture	The screen capture is preserved on the microSD card.
Engine cut	Engine cut
A.B.S.(Brake1)	A.B.S function brake1(2CH)ON/OFF
A.B.S.(Brake2,3)	A.B.S function brake2,3(3CH/4CH)ON/OFF
Neutral brake	Neutral brake function ON/OFF
Idle up	Idle up function ON/OFF
Program mixing(1-5)	Program mixing(1-5) function ON/OFF
4WS mixing	4WS mixing function ON/OFF & type select
Dual ESC (Rear)	Dual ESC mixing (Rear Drive mode)
Dual ESC (4WD)	Dual ESC mixing (4WD mode)
Dual ESC (Front)	Dual ESC mixing (Front Drive mode)
Gyro mixing	Switching GYRO mode (Switch of Gain1 and 2)
CPS mixing	CPS up function ON/OFF
Brake	Steering mixing (Brake function ON/OFF)
Timer start	Timer function start /stop
Timer reset	Timer function reset
Timer reset	Telemetry voice guide ON/OFF
Timer reset	Telemetry data logging ON/OFF
OFF	Not used

The HOME screen display

When push switch is operated in the HOME screen state, the state of the function is displayed in the center for about one or two seconds.

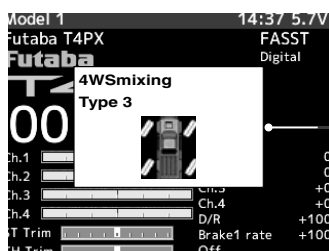

Example :4WS Mixing

When the set SW is operated in the HOME screen state, the 4WS mode is displayed here for about 2 seconds.

Dial Select

This function allows selection of the function performed by the digital dial DL1 and digital trimmers (DT1 ~ DT6), step amount adjustment, and operating direction reversal.

- The table in the next page lists the functions that can be assigned to each dial and digital trimmer. The assigned function is also displayed on the opening screen together with the current adjustment value. They are displayed in DL1 and DT1 ~ DT6 order, from top to bottom.
- The step amount can be adjusted. The table in the following page shows the relationship between set value and step amount.
- The operation direction can be reversed. (NOR/REV)

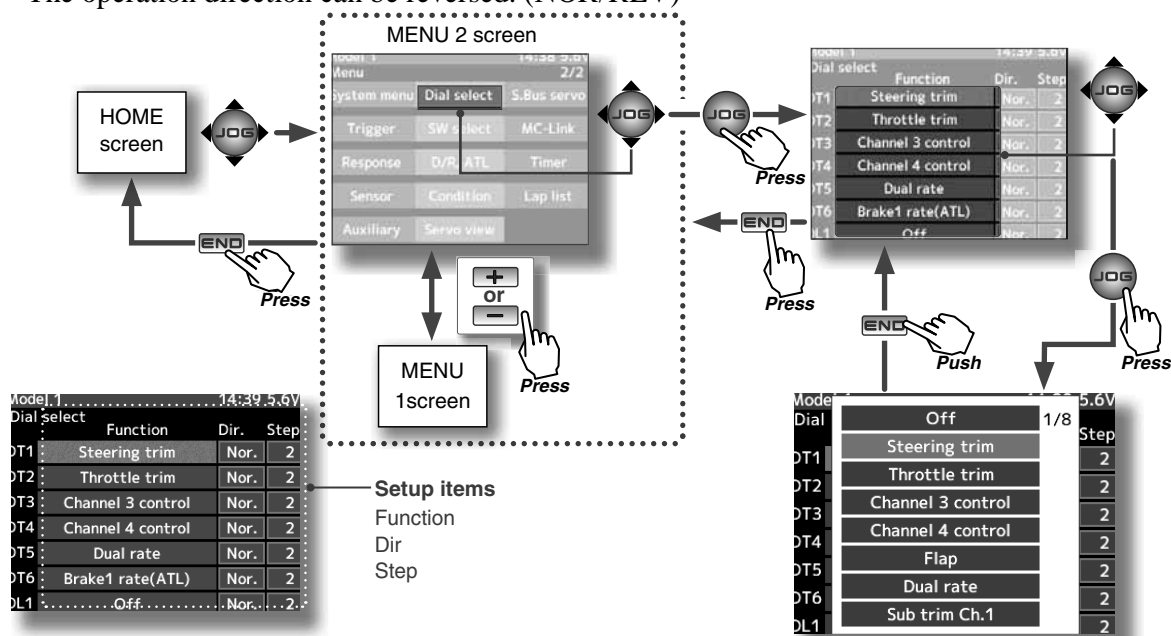

Function select dial setup

1 (Select dial selection)

Select "Function" of the trim or dial you want to set by (JOG) button up, down, left, or right operation, and press the (JOG) button.

2 (Function setup)

A function list is displayed. Select the desired function by (JOG) button up or down operation, and press the (JOG) button.

(Changing the operation direction)

Select "Direction" of the switch you want to set by (JOG) button up, down, left, or right operation and switch the direction by (+) or (-) button.

(Changing the operation step amount)

Select "Step" of the switch you want to set by (JOG) button up, down, left or right operation, and switch the type by (+) or (-) button.

- For the relationship between set value and step amount, see the preceding page

3 When ending setting, return to the menu screen by pressing the (END) button.

Setup item selection

- Select by (JOG) button up, down, left or right operation

Adjustment buttons

- Use the (+) and (-) buttons to make adjustments.
- Press the (+) and (-) buttons simultaneously (approx. 1 sec) to return to the initial screen.

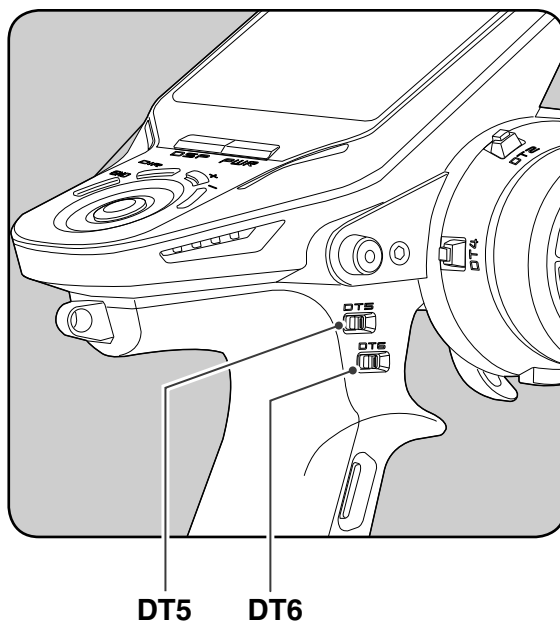
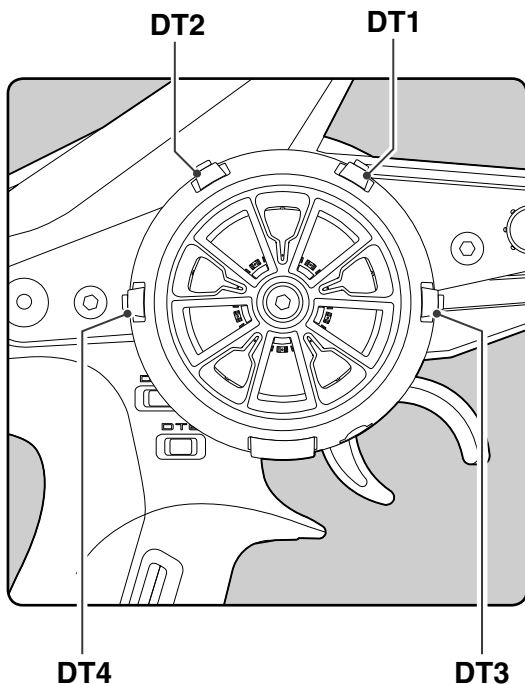

- Initial value:**
- DT1 :Steering trim
 - DT2 :Throttle trim
 - DT3 :Channel3 control
 - DT4 :Channel4 control
 - DT5 :Dual rate
 - DT6 :Brake1 rate(ATL)
 - DL1 :OFF
 - Dir:Nor/ Step:2

Relationship between set value and step amount

(Setting range: 1, 2, 5, 10, 20, 30, 40, 50, 100, 200)

-Steering trim/throttle trim

When set to the minimum "1", the total trim operating width is 200 clicks. For "100", the total operating width is 2 clicks and for 2PS, the total operating width is 1 click.

-Rate, etc. setting

This is the % value which is operated by 1 click relative to the set value of each rate. Since the total operating width of functions having a rate of -100~0~+100 is 200%, when set to "100", the total operating width is 2 clicks. Since the total operating width of functions with a 0~100 rate is 100%, "100" and "200" are operated by 1 click.

-Channel 3/4

When set to the minimum "1", the total operating width of channel 3 is 200 clicks. For "100", the total operating width is 2 clicks and "200" is operated by 1 click.

Set table functions (DL1/ DT1, DT2, DT3, DT4, DT5, DT6)

Abbreviation used on setup screen	Abbreviation displayed on opening screen	Function name, etc
Steering trim	ST Trim	Steering trim
Throttle trim	TH Trim	Throttle trim
Channel 3 control	Ch.3	Channel 3 control
Channel 4 control	Ch.4	Channel 4 control
Dual rate	D/R	Dual rate function
Sub trim Ch1~4	Sub trim Ch1~4	Sub trim Ch1~4
Acceleration(forward)	Accel, forward	Throttle acceleration (Forward side)
Acceleration(brake1)	Accel, brake1	Throttle acceleration (Brake1 side)
Acceleration(brake2)	Accel, brake2	Throttle acceleration (Brake2 side)
Acceleration(brake3)	Accel, brake	Throttle acceleration (Brake3 side)
Steering curve	ST curve	Steering curve (EXP) rate
Throttle curve	TH curve	Throttle curve (EXP) (Forward side)
Steering speed(turn)	ST speed(turn)	Steering speed (Turn side)
Steering speed(return)	ST speed(return)	Steering speed (Return side)
ABS(return brake1)	ABS1 ret.	Brake1 A.B.S. function (Return amount)
ABS(delay brake1)	ABS1 delay	Brake1 A.B.S. function (Delay amount)
ABS(cycle brake1)	ABS1 cycle	Brake1 A.B.S. function (cycle speed)
ABS(return brake2)	ABS2 ret.	Brake2 A.B.S. function (Return amount)
ABS(delay brake2)	ABS2 delay	Brake2 A.B.S. function (Delay amount)
ABS(cycle brake2)	ABS2 cycle	Brake2 A.B.S. function (cycle speed)
ABS(return brake3)	ABS3 ret.	Brake3 A.B.S. function (Return amount)
ABS(delay brake3)	ABS3 delay	Brake3 A.B.S. function (Delay amount)
ABS(cycle brake3)	ABS3 cycle	Brake3 A.B.S. function (cycle speed)
Brake1 rate(ATL)	Brake1 rate	Brake1 rate (ATL)
Brake EXP(brake1)	Brake1 EXP	Throttle EXP (Brake1 side)
Brake delay(brake1)	Brake1 delay	Brake mixing: Brake1 delay
Brake2 rate	Brake2 rate	Brake mixing: Brake2 rate function
Brake EXP(brake2)	Brake2 EXP	Brake mixing: Throttle EXP (Brake2 side)
Brake delay(brake2)	Brake2 delay	Brake mixing: Brake2 delay
Brake3 rate	Brake3 rate	Brake mixing: Brake3 rate function
Brake EXP(brake3)	Brake3 EXP	Brake mixing: Throttle EXP (Brake3 side)
Brake delay(brake3)	Brake3 delay	Brake mixing: Brake3 delay
Brake2,3 rate	Brake2,3 rate	Brake mixing: Brake2,3 rate function
Tilt mixing (RUD → FLP)	Tilt R to F	Tilt mixing: rudder to flap rate
Tilt mixing (FLP → RUD)	Tilt F to R	Tilt mixing: flap to rudder rate
Idle up	Idle up	Idle up function rate
Prog. mixing 1~5 A	P.mix 1~5 A	Program mixing: rate A side (Left/Forward/Up sides)
Prog. mixing 1~5 B	P.mix 1~5 B	Program mixing: rate B side (Right/Brake/Down sides)
4WS rear rate	4WS rate	4WS mixing: (rear steering rate)
Dual ESC	Dual ESC	Dual ESC mixing (Drive mode select)
Dual ESC ratio	ESC ratio	Dual ESC mixing: drive ratio (front & rear)
Gyro Gain	Gyro	Gyro mixing: (Gain rate)
Ackermann rate	Ackermann	Ackermann mixing: (ackermann rate)
Steering response	ST response	Steering response adjustment
Throttle response	TH response	Throttle response adjustment
Flap	Flap	Tilt mixing: flap rate
OFF	Off	Not used

Timer Function

Use the timer by selecting one of the four timers Up timer, Fuel down timer, Lap timer and Lap navigate timer.

Up timer function

- The Up timer can be used to count the time between start and stop, etc.

- The timer repeatedly starts and stops each time the switch is operated and accumulates the time between each start and stop. (When the count reaches 99 minutes 59 seconds, it returns to 00 minutes 00 seconds and repeats the count.)

- The first start operation can be linked to the throttle trigger.

- An alarm sound can be set. The passage of time is announced by sounding of a buzzer (beeps) each minute after starting.

- Alarm :Generates a beep at the set time (minutes).

- Prealarm :Alarm advance announcement sound. Sounding begins 10 seconds before the set alarm time.

- After starting, the timer is enabled and can be stopped by switch even when the display switches to another screen.



Fuel down timer function

The fuel down timer is used primarily to check the refueling time of gasoline engine cars. (The remaining time is displayed.)

- Each time the switch is pressed, the timer is restarted and the set time is counted down. The start time becomes the alarm set time. (When counted down to 00 minutes 00 seconds, the timer becomes an Up timer.)

- The fuel down timer can be initially started by throttle trigger.

- An audible alarm can be set. In addition, the passing of time is indicated by sounding of a buzzer each minute after starting.

- Alarm :Buzzer sounds at the set time (minute).

- Prealarm :Alarm advance announcement sound. Sounding begins 10 seconds before the set alarm time.

- After starting, the timer continues to count even if the LCD switches to another screen.



Lap timer function

Lap timer function

- The Lap timer can memorize each lap time of each switch operation. (60 laps)
- The race time can be set. Switch operation after the set time by alarm has elapsed automatically stops the timer. Prealarm can also be set. The passage of time is announced by sounding of a buzzer (beeps) each minute after starting.

-Alarm :Generates a beep at the set time.
Prealarm :Starts sounding the set time (second) before the alarm. (beeps)

- The first start operation can be linked with the throttle trigger.

(Lap timer operation)

- When lap timer is selected, the number of laps (LAP) and the lap memory No. (No.) and current lap time (TIME) are displayed on the setup screen.

*LAP: Counted up each time the switch is pressed after starting. After the switch was pressed, the numbers pause for 3 seconds. To prevent erroneous counting, switch operation is not accepted during this time

*Lap memory: The lap memory saves the lap times of 60 laps.

*The lap time data stored in the lap memory can be checked at the lap list (P111) screen.



Lap navigate timer function

Lap navigate timer function

- This function sounds a buzzer at a fixed interval after the timer starts. Since only the buzzer can be restarted when the switch is pressed during timer operation, this function can be used as the training run, etc. target time. (Lap navigation alarm) The passage of time is announced by sounding of a buzzer (beeps) every minute after starting.

- The first start operation can be linked with the throttle trigger.

- The alarm sounds (alarm/prealarm) can be set separately from the fixed interval buzzer.

- Alarm :Generates a beep at the set time (minutes).
- Prealarm :Alarm advance announcement sound. Sounding begins 10 seconds before the set alarm time.
- After starting, the timer is enabled and can be stopped by switch even when the display switches to another screen.



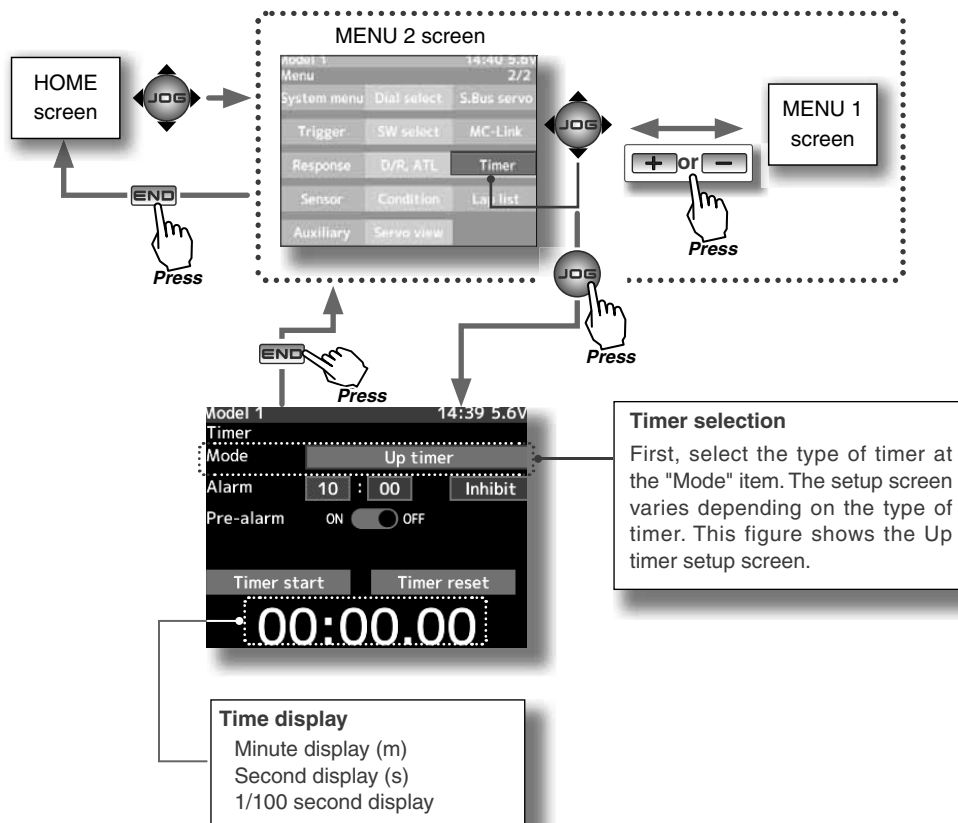

Racing timer type selection

(Preparation)

Assign the "Timer start" switch using the function select switch (p.99). When resetting by switch, assign "Lap reset" also.

1 (Racing timer type selection)

Select the setting item "Mode" by (JOG) button up, down, left, or right operation. Press the (+) or (-) button and set the racing timer type.

- Timer selection (TYPE)
- Up timer
 - Fuel down timer
 - Lap timer
 - Lap navigate timer

Setup item selection

- Select by (JOG) button up, down, left or right operation.

Adjustment buttons

- Use the (+) and (-) buttons to make adjustments.

2 When ending setting, return to the menu screen by pressing the (END) button.

Using the Up timer

(Preparation)

Select the setting item "Mode" by (JOG) button up or down operation. Press the (+) or (-) button and select "Up timer".

1 (Alarm time setting)

Select the setting item "Alarm" by (JOG) button up, down, left, or right operation and set the alarm time with the (+) and (-) buttons.

The setting item at the right side of the alarm time is the alarm vibration setting. Select one of the 3 patterns or inhibit (OFF) by (+) or (-) button.

(Pre alarm time setting)

Select the setting item "Pre-alarm" by (JOG) button up, down, left, or right operation, and set the pre alarm to the active state by pressing the (+) or (-) button.

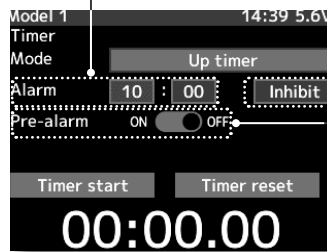

Adjustment buttons

- Use the (+) and (-) buttons to make adjustments.
- Press the (+) and (-) buttons simultaneously (approx. 1 sec) to return to the initial screen.

Alarm time

OFF, 1 ~ 99 m
Initial value: 5 m

Grip vibrator type

Inhibit(Off), Type1,2,3
Initial value: Inhibit

Prealarm time

OFF, ON
Initial value: OFF

2 (Timer start/stop operation)

When the switch ("Timer start") assigned by function select switch function is pressed, the timer starts. Stop the timer with the same switch ("Timer start") as start, or with the switch assigned the "Lap reset" function.

- Linking only start to the throttle trigger

Select the setting item "Timer start" by (JOG) button up, down, left, or right operation and press the (+) and (-) buttons simultaneously for about 1 second. When the set beeps and the status display switches from "Timer start" to "Ready", the system enters the trigger operation ready state. When the trigger is operated at the forward side, the timer starts. (Status display "Timer start")

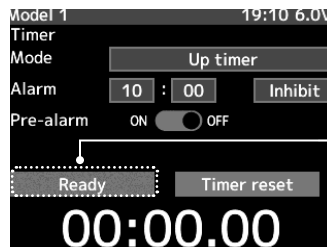

Switches

Timer start :start / stop
Lap reset :stop / reset

Status display

Ready:
Throttle trigger operation wait
Timer start:
Timer running/ Timer stopped

3 (Timer reset operation)

When the switch ("Timer reset") assigned by function select switch function is pressed, the timer is reset.

When a switch is not set, select "Timer reset" by (JOG) button up or down operation, and press the (JOG) button. A beeping sound is generated and the timer is reset.

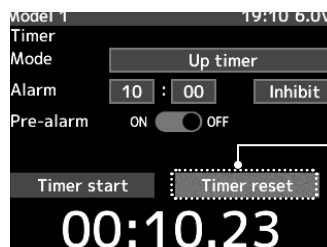

Timer start/ reset

Using the fuel down timer

(Preparation)

Select the setting item "Mode" by (JOG) button up or down operation. Press the (+) or (-) button and select "Fuel down timer".

Adjustment buttons

- Use the (+) and (-) buttons to make adjustments.
- Press the (+) and (-) buttons simultaneously (approx. 1 sec) to return to the initial screen.

1 (Alarm time setting)

Select the setting item "Alarm" by (JOG) button up, down, left, or right operation and set the alarm time with the (+) and (-) buttons.

The setting item at the right side of the alarm time is the alarm vibration setting. Select one of the 3 patterns or inhibit (OFF) by (+) or (-) button.

(Pre alarm time setting)

Select the setting item "Pre-alarm" by (JOG) button up, down, left, or right operation, and set the pre alarm to the active state by pressing the (+) or (-) button.

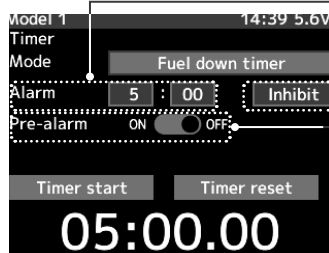

Alarm time

OFF, 1 ~ 99 m
Initial value: 5 m

Grip vibrator type

Inhibit(Off), Type1,2,3
Initial value: Inhibit

Prealarm time

OFF, ON
Initial value: OFF

2 (Timer start/stop operation)

When the switch ("Timer start") assigned by function select switch function is pressed, the timer starts. Stop the timer with the same switch ("Timer start") as start, or with the switch assigned the "Lap reset" function.

- Linking only start to the throttle trigger

Select the setting item "Timer start" by (JOG) button up, down, left, or right operation and press the (+) and (-) buttons simultaneously for about 1 second. When the set beeps and the status display switches from "Timer start" to "Ready", the system enters the trigger operation ready state. When the trigger is operated at the forward side, the timer starts. (Status display "Timer start")



Switches

Timer start :start / stop
Lap reset :stop / reset

Status display

Ready:
Throttle trigger operation wait
Timer start:
Timer running/ Timer stopped

3 (Timer reset operation)

When the switch ("Timer reset") assigned by function select switch function is pressed, the timer is reset. When a switch is not set, select "Timer reset" by (JOG) button up or down operation, and press the (JOG) button. A beeping sound is generated and the timer is reset.

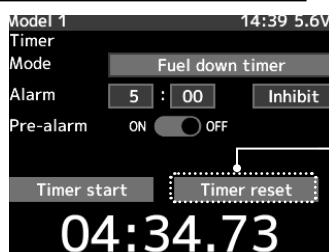

Timer start/ reset

Using the Lap timer

(Preparation)

Select the setting item "Mode" by (JOG) button up or down operation. Press the (+) or (-) button and select "Lap timer".

1 (Alarm time setting)

Select the setting item "Alarm" by (JOG) button up, down, left, or right operation and set the alarm time with the (+) and (-) buttons.

The setting item at the right side of the alarm time is the alarm vibration setting. Select one of the 3 patterns or inhibit (OFF) by (+) or (-) button.

(Pre alarm time setting)

Select the setting item "Pre-alarm" by (JOG) button up, down, left, or right operation, and set the pre alarm to the active state by pressing the (+) or (-) button.

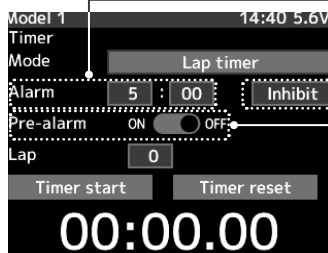

Adjustment buttons

- Use the (+) and (-) buttons to make adjustments.
- Press the (+) and (-) buttons simultaneously (approx. 1 sec) to return to the initial screen.

Alarm time

OFF, 1 ~ 99 m
Initial value: 5 m

Grip vibrator type

Inhibit(Off), Type1,2,3
Initial value: Inhibit

Prealarm time

OFF, ON
Initial value: OFF

2 (Timer start/lap count operation)

Perform the start and lap count operations with the switch ("Timer start") assigned by function select switch function.

- Linking only start to the throttle trigger.

Select the setting item "Timer start" by (JOG) button up, down, left, or right operation and press the (+) and (-) buttons simultaneously for about 1 second. The set beeps and the timer display changes from "Timer start" to "Ready" and the set enters the trigger operation ready state. (Status display "Timer star")

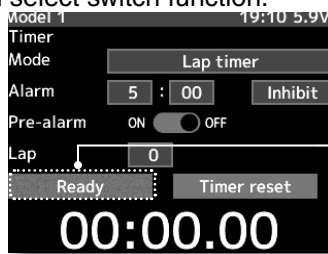

Switches

Timer start :start / stop
Lap reset :stop / reset

Status display

Ready:
Throttle trigger operation wait
Timer start:
Timer running/ Timer stopped

Will not start if the last lap timer is not reset

3 (Timer stop/reset operation)

When the lap count switch or "Timer reset" switch is pressed after the time set by "Alarm" has elapsed and the lap time, total time, and average lap time are saved and checked. (Lap list p.111)

If the switch ("Timer reset") set by switch setting function is pressed, the timer is reset. When a switch is not set, select "Timer reset" by (JOG) button up or down operation, and press the (JOG) button. A beeping sound is generated and the timer and lap list are reset.

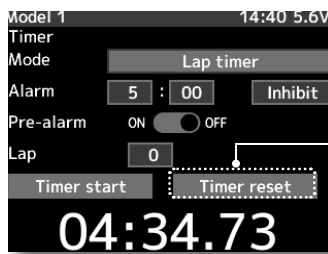

Timer start/ reset

Be careful because timer reset clears the lap list.

Using the navigate timer

(Preparation)

Select the setting item "Mode" by (JOG) button up or down operation. Press the (+) or (-) button and select "Lap navigate timer".

1 (Alarm time setting)

Select the setting item "Alarm" by (JOG) button up, down, left, or right operation and set the alarm time with the (+) and (-) buttons.

The setting item at the right side of the alarm time is the alarm vibration setting. Select one of the 3 patterns or inhibit (OFF) by (+) or (-) button.

(Pre alarm time setting)

Select the setting item "Pre-alarm" by (JOG) button up, down, left, or right operation and set the pre alarm time with the (+) and (-) buttons.

(Lap navigation time setting)

Select the setting item "Lap navi" by (JOG) button up, down, left, or right operation and set the lap navigation alarm (target) time with the (+) and (-) buttons.

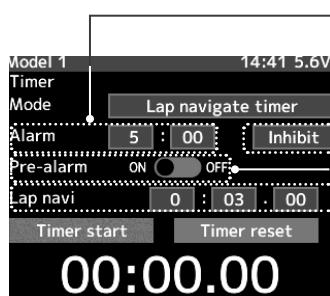

Adjustment buttons

- Use the (+) and (-) buttons to make adjustments.
- Press the (+) and (-) buttons simultaneously (approx. 1 sec) to return to the initial screen.

Alarm time

OFF, 1 ~ 99 m
Initial value: 5 m

Grip vibrator type

Inhibit(Off), Type1,2,3
Initial value: Inhibit

Prealarm time

OFF, ON
Initial value: OFF

Navi alarm time (NAVI)

OFF, 1 ~ 99 s
Initial value: 3 s

2 (Timer start/navigation restart operation)

When the switch ("Timer start") assigned by function select switch function is pressed, the timer starts.

- Linking only start to the throttle trigger

Select the setting item "Timer start" by (JOG) button up, down, left, or right operation and press the (+) and (-) buttons simultaneously for about 1 second. The set beeps and the status display changes from "Timer start" to blinking "Ready" and the set enters the trigger operation ready state. When the trigger is operated at the forward side, the timer starts. (Status display "Timer start")

When your own lap time is less than the target time and the lap counts overlap, the lap navigation alarm timing is too big. The alarm timing can be corrected by pressing the switch ("Timer start") during measurement.



Switches

Timer start :start / stop
Lap reset :stop / reset

Status display

Ready:
Throttle trigger operation wait
Timer start:
Timer running/ Timer stopped

3 (Timer stop/reset operation)

When the switch ("Timer reset") assigned by function select switch function is pressed, the timer is reset. When a switch is not set, select "Timer reset" by (JOG) button up or down operation, and press the (JOG) button. A beeping sound is generated and the timer and lap list are reset.

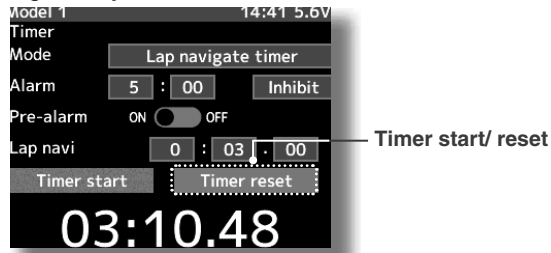

Lap List

Call Lap list when checking the lap memory data (each lap time) memorized by lap timer (p.105, 109) operation.

- After the lap timer is started, the lap time is sequentially memorized at each switch operation.
- The total time and average time are displayed. The faster time is displayed in red characters.
- Lap time data is saved in each model data.
- Up to 60 laps can be saved.
- If the lap timer is reset, the lap list is also cleared.

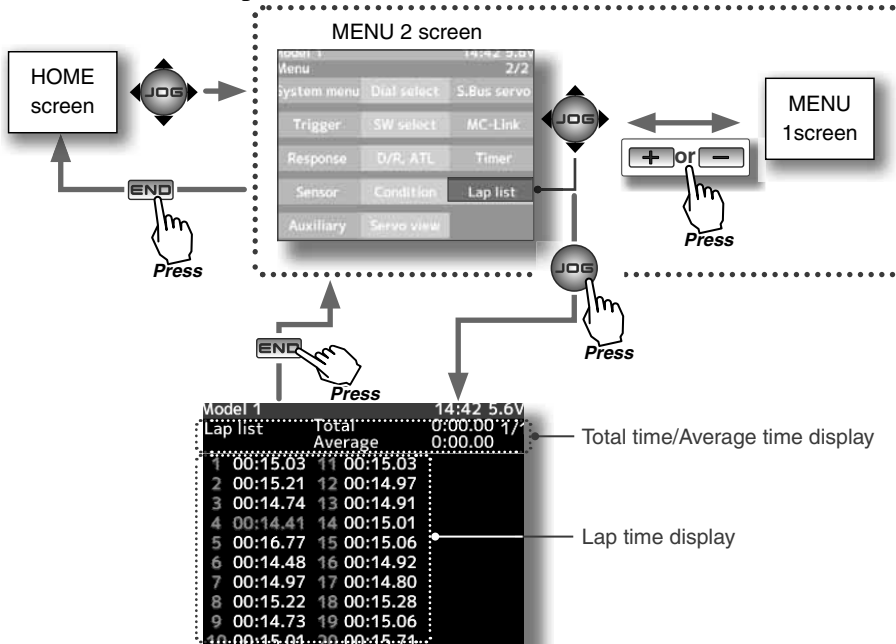

Using the lap memory

1 (Lap memory check)

The lap list displays up to 30 laps on page 1 and 60 laps on page 2. The page is switched by (+) or (-) button.

2 When ending setting, return to the menu screen by pressing the (END) button.

Model Select

Forty model data (model data for 40 R/C cars) can be saved in the T4PX transmitter and used when the relevant model data is called.

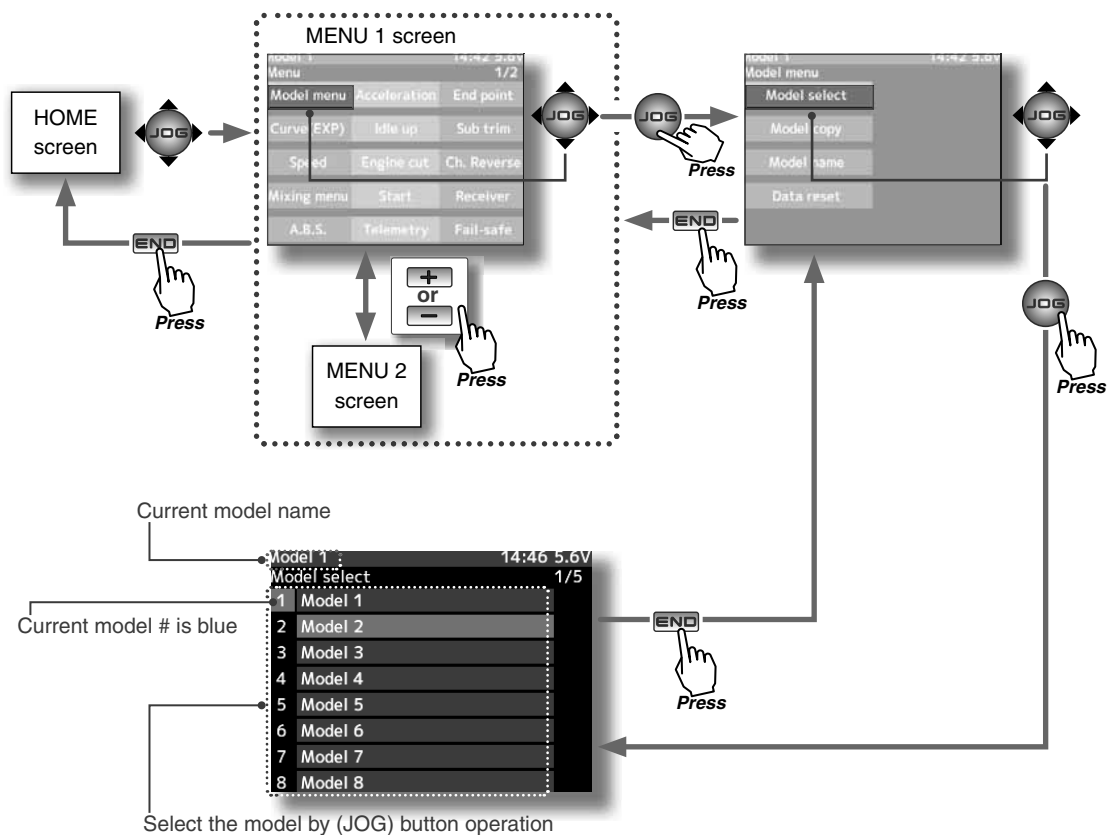

Using the model selection function

Function

1 (Model No. selection)

Select the model by (JOG) button up or down operation.

When the (JOG) button up operation is performed from the cursor position on the top row or the (JOG) button down operation is performed from the cursor position on the bottom row, the page changes.

Model #.

M1~M40

Model selection button

- Select the model by (JOG) button up or down operation.

2 (Model selection execution)

When the model was selected, press the (JOG) button. The confirmation message "Are you sure?" appears. To execute selection, select "Yes" and press the (JOG) button and to cancel selection, select "No" and press the (JOG) button.



Model selection set button

- The (JOG) button are pressed.

3 When ending setting, return to the menu screen by pressing the (END) button.

Model Name

This function allows you to assign a ten character name to each model memory.

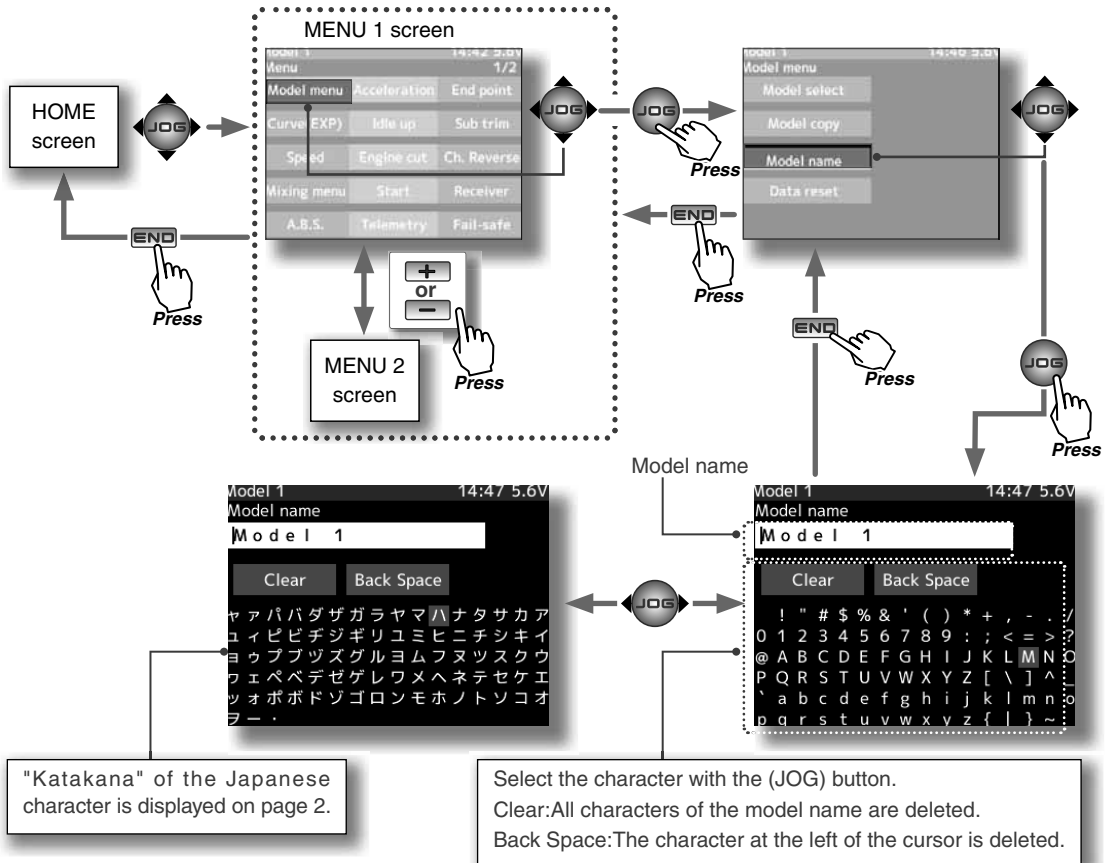

Setting the model name and user name

- 1** (Moving the cursor to the character you want to change.)
Move the cursor to the model name character you want to set or change by pressing the (+) or (-) button. The selected character blinks.
- 2** (Selecting the character to be used)
Move the cursor by (JOG) button up, down, left, or right operation, and select the characters to be used from the character list at the bottom of the screen. After deciding the characters to be used, press the (JOG) button. The characters are selected and the model name character string moves to the right. When "Back space" on the center row is selected and the (JOG) button is pressed, the character at the left of the vertical cursor is deleted. When "Clear" is selected and the (JOG) button is pressed, all the characters are deleted.
- 3** When ending setting, return to the menu screen by pressing the (END) button.

Character select/set button

- Select the character by (JOG) button up, down, left, or right operation and enter the character by pressing the (JOG) button.

Model Copy

The contents of the model memory can be copied to another model memory. The contents can also be saved or stored in a microSD card for copying to another T4PX.

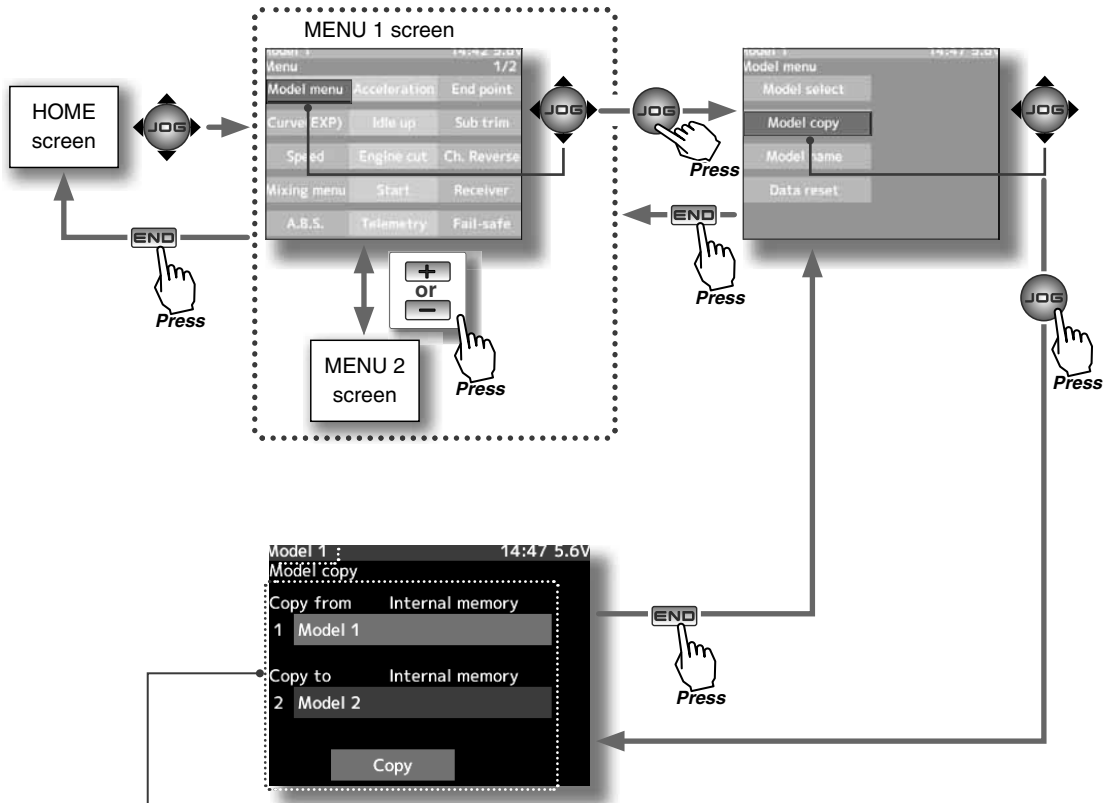

Selects the copy source model and copy destination model data.

Model copying

1 (Copy source model selection)

Select the setting item "Copy source" by (JOG) button up or down operation. Press the (JOG) button. A list of the models stored in the T4PX transmitter is displayed. Select the model by (JOG) button up or down operation, and press the (JOG) button.

When a microSD card is installed in the T4PX, a screen for selecting T4PX model memory (Internal memory) or microSD card is displayed.

After selecting either T4PX model memory or microSD card by (JOG) button, select the model.

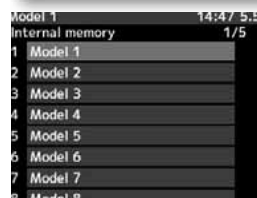
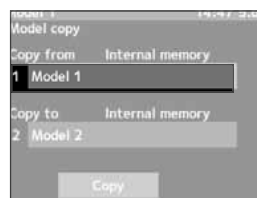

Setup item selection

- Select by (JOG) button up or down operation.

Model number selection

- The (JOG) button are pressed

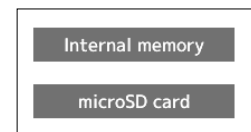

T4PX transmitter or microSD card selection

2 (Copy destination model selection)
 Select the setting item "Copy Source" by (JOG) button up or down operation, and press the (JOG) button. A list of the model numbers saved in the T4PX transmitter is displayed. Select the model by (JOG) button up or down operation, and press the (JOG) button. When a microSD card is installed in the T4PX transmitter, a screen for selecting the models in the T4PX transmitter (Internal memory) or the models in the microSD card is displayed.

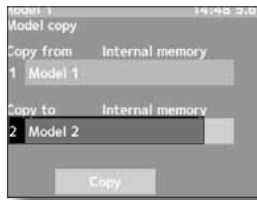

Setup item selection
 - Select by (JOG) button up or down operation.
Model number selection
 - The (JOG) button are pressed

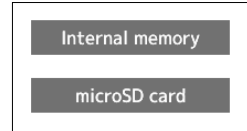
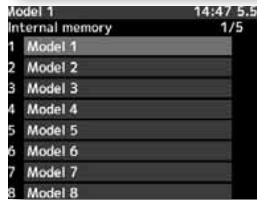

T4PX transmitter or microSD card selection

After selecting the screen by (JOG) button, select the model.

- The model currently in use cannot be selected.
- Since the copy destination cannot be overwritten when it is in a microSD card, a models list is not displayed and the model is saved directly to the microSD card.

3 (Copy execution)

After checking that the copy source and copy destination models are correct, select the setting item "Copy execution" by (JOG) button up or down operation, and press the (JOG) button. The confirmation message "Are you sure" appears. To execute copy, select "Yes" and to cancel copy, select "No" by (JOG) button.

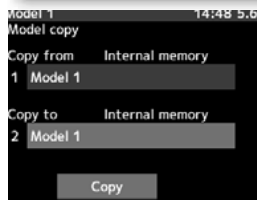
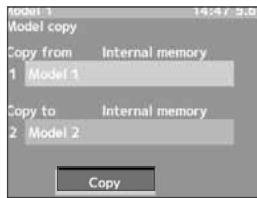

When the copy destination model name becomes the same name as the copy source, copying is complete.

4 When ending setting, return to the menu screen by pressing the (END) button.

microSD card storage destination

When a microSD card is installed in the T4PX, a folder called "Futaba" is created, and folders called "LOG" and "MODEL" are created in it. The "MODEL" folder contains the model data.

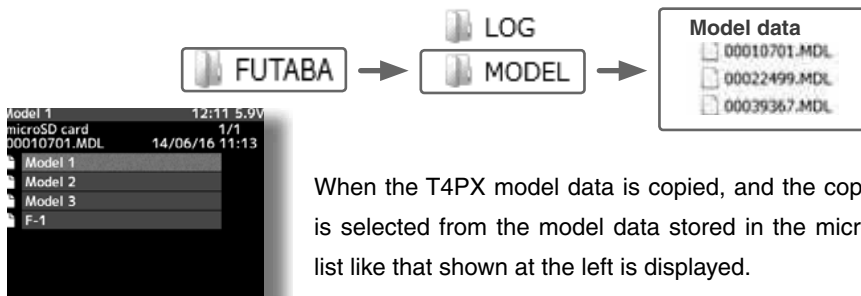

When the T4PX model data is copied, and the copy source data is selected from the model data stored in the microSD, a model list like that shown at the left is displayed.

MC Link Function (ESC Link)

This is a special function which allows Futaba motor controller (MC) data changes to be set by the T4X transmitter (MC960CR, MC950CR, MC851C, MC602C, MC402CR, etc.).

However, some data changes require a PC and Link software.

This function is used by connecting ESC directly to the transmitter.

Use the various optional servo extension cords according to the distance between the transmitter and ESC.

-Also connect the battery at the ESC side.

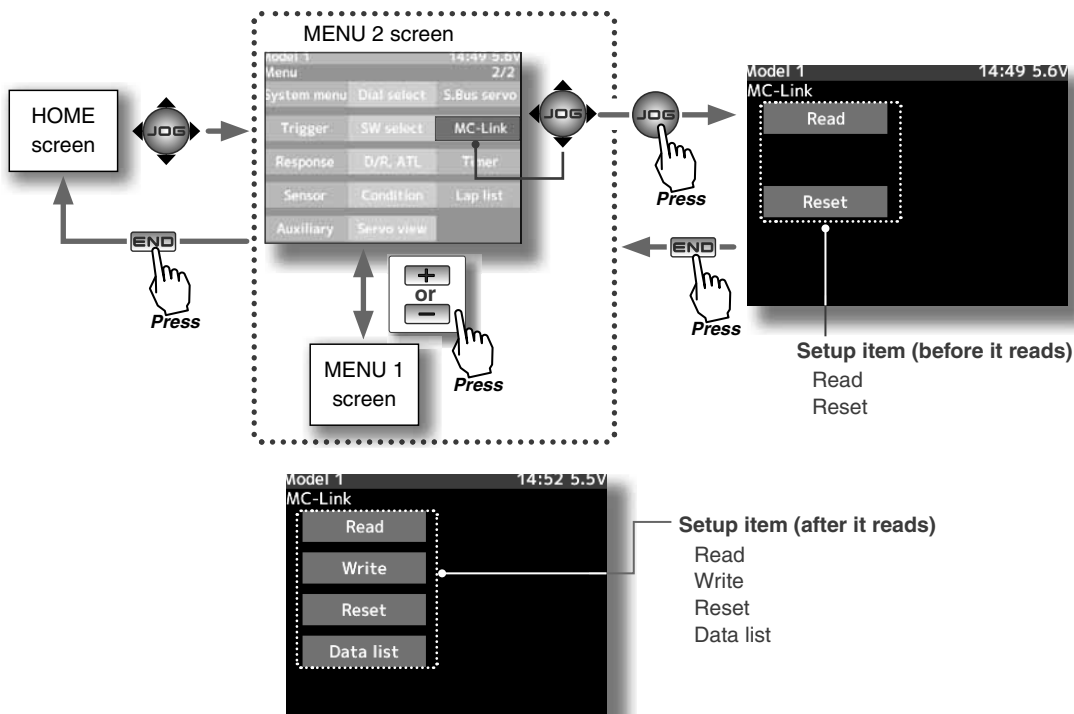
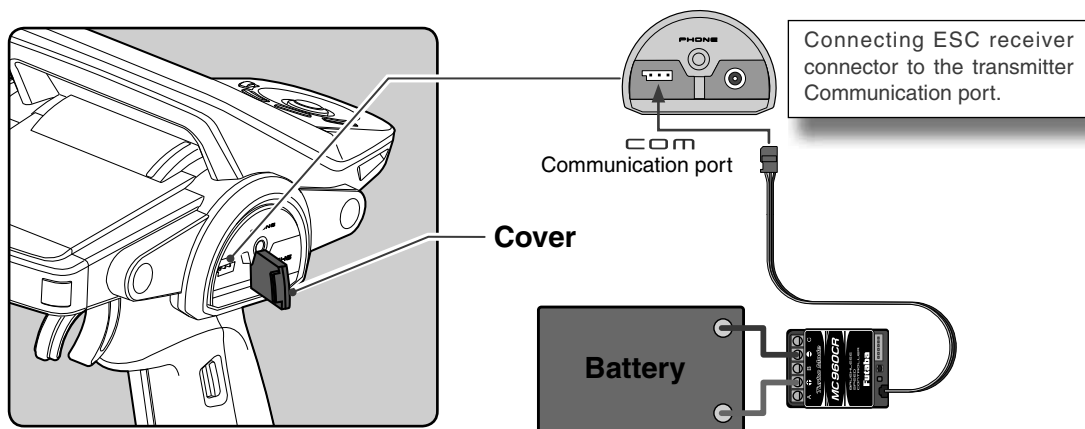

Function

Using the ESC Link function

(Preparation)

- Connect the T4PX and ESC in accordance with the connection diagram shown on page 117.
- Connect the battery to ESC.

1 Turn power on the transmitter. "MC link" menu is displayed referring to the map of page 117. Set the FET amp power switch to the ON position.

Setup item selection

- Select by (JOG) button up or down operation.

Reset execution button

- (JOG) buttons pressed.

2 (ESC read)

Execute this function to read the connected ESC type and the data currently set at the ESC.

-Select the setting item "Read" by (JOG) button up or down operation, and press the (JOG) button.

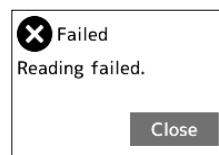
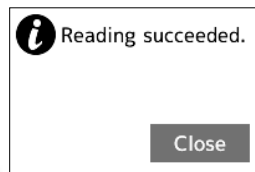

-"Reading succeeded" is displayed on the screen and the ESC type and currently set contents are read.

- If "Failed" is displayed on the screen, communication with the ESC is not being performed normally. Check the T4PX and ESC connection and the battery connection to ESC and the ESC power switch and repeat "Read".

3 (Writing to ESC)

Execute this function to write the setting data to ESC. See pages 120~125 for the setting data contents.

-Select the setting item "Write" by (JOG) button up or down operation, and press the (JOG) button.

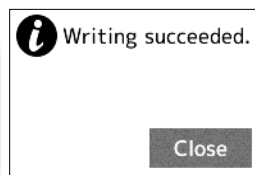

-"Writing succeeded" is displayed on the screen and the setting data is written to ESC.

- If "Failed" is displayed on the screen, communication with the ESC is not being performed normally. Check the T4PX and ESC connection and the battery connection to ESC and the ESC power switch and repeat "Write".

- Different type ESC data cannot be written. If writing is attempted, "Failed" is displayed on the screen.

4 (Initialization)

Write the factory set ESC setting data to the connected ESC and T4PX.

-Select the setting item "Reset" by (JOG) button up or down operation, and press the (JOG) button.

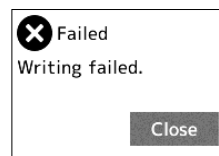
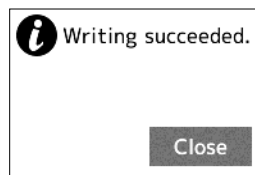

-"Writing succeeded" is displayed on the screen and the setting data is written to ESC.

- If "Failed" is displayed on the screen, communication with the ESC is not being performed normally. Check the T4PX and ESC connection and the battery connection to ESC and the ESC power switch and repeat "Write".

Data list

(Preparation)

-ESC is read referring to the explanation of page 118.

1 Select the setting item "Data list" by (JOG) button up or down operation, and press the (JOG) button.

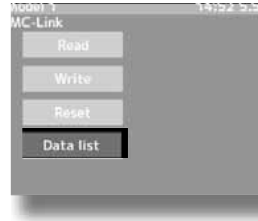

Setup item selection

- Select by (JOG) button up or down operation.

Reset execution button

- (JOG) buttons pressed.

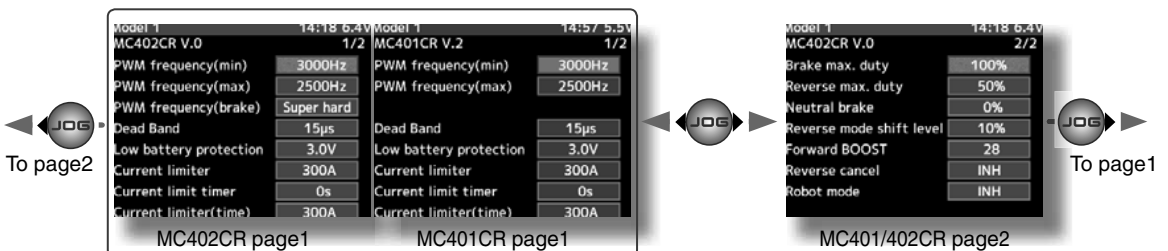
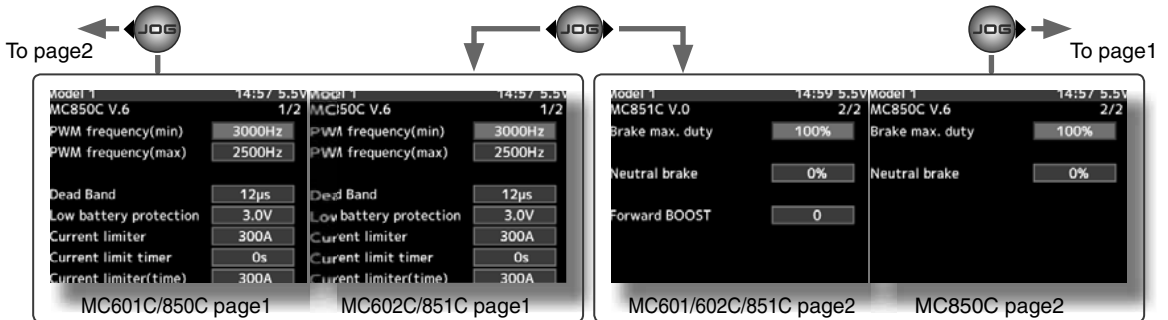
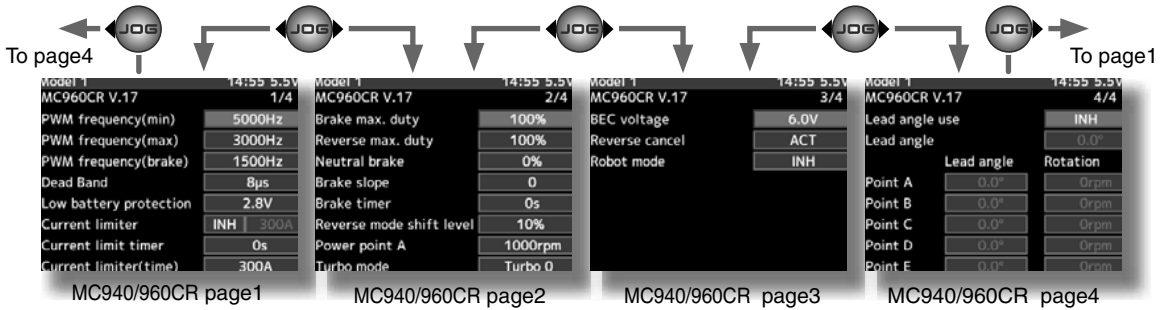

Function

System function setup

- Select the setting item by (JOG) button up, down, left, or right operation.
Set the value by (+) and (-) button.

PWM frequency (min)

MC401,402CR/601,602C/850,851C :0.1kHz(100Hz) 10kHz (10000Hz)

MC950CR :0.5kHz(500Hz) 30kHz(30000Hz)

MC940,960CR :1kHz(1000Hz) 30kHz(30000Hz)

Same as Link software PWM frequency (at Min. load),

MIn sets the "0"A PWM frequency at minimum load.

PWM frequency (max)

MC401,402CR/601,602C/850,851C:0.1kHz(100Hz) 10kHz (10000Hz)

MC950CR :0.5kHz(500Hz) 30kHz(30000Hz)

MC940,960CR :1kHz(1000Hz) 30kHz(30000Hz)

Same as Link software PWM frequency (at Max. load).

MAX sets the PWM frequency at maximum load at the output current limit value set by Current Limiter.

PWM frequency (brake)

MC402CR/602C/851C (MC401,601,850 cannot be adjusted 2kHz fixation)

:Normal(2000Hz) /Hard(1000Hz) /Super hard(500Hz)

MC950CR :0.5kHz(500Hz)30kHz(30000Hz)

MC940,960CR :1kHz(1000Hz)30kHz(30000Hz)

Same as Link software Brake PWM at frequency.

This setting can set the brake PWM frequency.

"min" which sets the frequency when the load is small, is set to the high frequency side (large value) when extension is desired after straightaways and curves.

"max" which sets the frequency when the load is large, is set to the high frequency side (large value) when you want to suppress the rise from low speed and when motor heating and commutator roughness are sensed.

When the rise from low speed is poor, and becomes bad even when "max" is set to the low frequency side, use the log data to check if there was a momentary voltage drop. When you want to suppress the overall power, lengthen the run time, and otherwise improve efficiency, set both "max" and "min" to the high frequency side. When you want to set a fixed PWM frequency at full range regardless of the load current, set PWM frequency (at Max. load) and PWM frequency (at Min. load) to the same value.

Model 1	14:55 5.5V
MC960CR V.17	1/4
PWM frequency(min)	5000Hz
PWM frequency(max)	3000Hz
PWM frequency(brake)	1500Hz
Dead Band	8µs
Low battery protection	2.8V
Current limiter	INH 300A
Current limit timer	0s
Current limiter(time)	300A

Dead Band

All type :±2µs~±50µs

Same as Link software Dead Band.

This sets the range (neutral point range) over which the ESC does not respond to transmitter throttle operation.

The larger the set value, the wider this range.

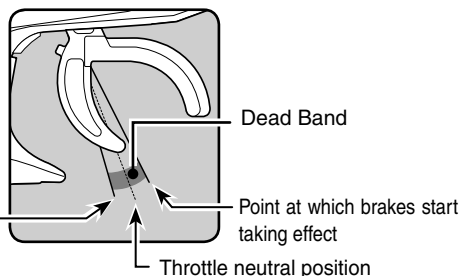

Model 1	14:55 5.5V
MC960CR V.17	1/4
PWM frequency(min)	5000Hz
PWM frequency(max)	3000Hz
PWM frequency(brake)	1500Hz
Dead Band	8µs
Low battery protection	2.8V
Current limiter	INH 300A
Current limit timer	0s
Current limiter(time)	300A

Low Bat Protection

MC401,402CR/601,602C/850,851C:2.5V 6.0V

MC950CR/MC940,960CR 2.5V 7.5V

Same as Link software Low Bat Protection.

When the power supply voltage drops, the output current to the motor is limited and supply voltage to the receiver is ensured. When the power supply voltage drops to the set voltage, a protection circuit operation alarm is activated and output to the motor is cut. The protection circuit is automatically reset by recovery of the power supply voltage.

Current Limiter

MC401,402CR/601,602C/850:50A 300A, INH

MC851C :50A~300A(can not INH)

MC950CR/MC940,960CR:50A~500A, INH

Same as Link software PWM frequency (at Max. load).

MAX sets the PWM frequency at maximum load at the output current limit value set by Current Limiter.

Model 1	14:55 5.5V
MC960CR V.17	1/4
PWM frequency(min)	5000Hz
PWM frequency(max)	3000Hz
PWM frequency(brake)	1500Hz
Dead Band	8µs
Low battery protection	2.8V
Current limiter	INH 300A
Current limit timer	0s
Current limiter(time)	300A

Current limiter INH/ACT setting

With the MC950CR and MC940/960CR move the cursor to current limiter "INH(Off)/ACT(On)" and select INH or ACT with the (+) or (-) button.

With other MC, when the (+) button is pressed from the current limiter maximum value, INH(Off) is set.

The MC851C does not have an INH(Off) setting.

Current Limit timer

MC401,402CR/601,602C/850,851C:0sec(OFF)240sec

MC940,960CR:0sec(OFF)~240sec (MC950CR can not)

Same as Link software Current Limit timer.

The output current can be limited up to the set time lapse from the start of running. This is effective in preventing the motor from outputting wasted energy when the voltage is high immediately after the power battery was re-charged.

"Current Limiter (time)" sets the time the output current is limited. This function is disabled when set to "0" sec.

Since the Current Limit Timer starts when the throttle is operated to the forward side and current is output to the motor, this function begins to operate when the motor is run during trim adjustment, etc.

Current Limiter (time)

MC401,402CR/601,602C/850,851C :50A~300A

MC940,960CR :50A~500A (MC950CR can not)

"Current Limit timer " (Time Limit) sets the maximum output current within the time the output current is limited.

Model 1	14:55 5.5V
MC960CR V.17	1/4
PWM frequency(min)	5000Hz
PWM frequency(max)	3000Hz
PWM frequency(brake)	1500Hz
Dead Band	8µs
Low battery protection	2.8V
Current limiter	INH 300A
Current limit timer	0s
Current limiter(time)	300A

Model 1	14:18 6.4V
MC402CR V.0	1/2
PWM frequency(min)	3000Hz
PWM frequency(max)	2500Hz
PWM frequency(brake)	Super hard
Dead Band	15µs
Low battery protection	3.0V
Current limiter	300A
Current limit timer	0s
Current limiter(time)	300A

Brake max. duty

All type :0%~100%

Same as Link software Brake Max. Duty.

This setting can set the braking force between the neutral point and Max brake point.

The larger this value, the greater the braking force. When set to "0%", the brakes are not effective.

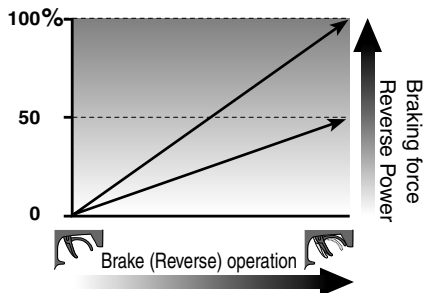

Reverse max. duty

MC401,402CR/MC950CR/MC940,960CR :0%~100%

Same as Link software Reverse Max. Duty.

This setting can set the reverse power between the neutral point and Max reverse point.

The larger this value, the greater the reverse power. When set to "0%", the reverses are not effective.

Neutral brake

All type :0%~100%

Same as Link software Current Limit timer.

Make this setting when you want to use the brakes at the neutral throttle (OFF) position by throttle operation. The larger this value, the greater the braking force. When you want to use the neutral brake, set this value to "0%".

MC401,402CR/MC950CR/MC940,960CR

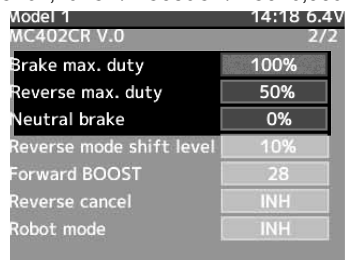

MC601,602C/MC850,851C

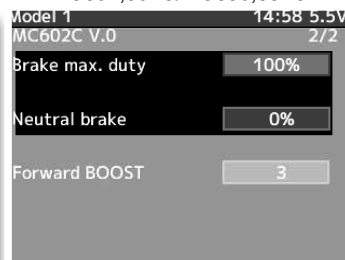

Reverse mode shift level

MC401,402CR/MC950CR/MC940,960CR :0%~100%

Same as Link software Reverse Mode Shift Level.

The reverse operation can be done with the throttle trigger to be thrown from brake status to the neutral. The value can set the amount of the brake in order to switch to the reverse operation.

MC401,402CR

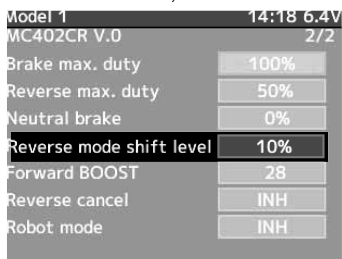

MC950CR/MC940,960CR

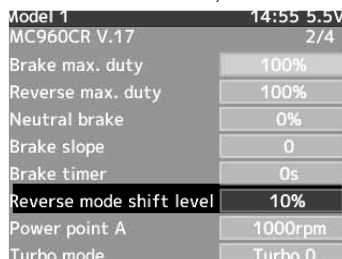

Forward BOOST

MC401,402CR/MC601,602C/MC851C :0%~100%

Same as Link software Forward Boost (Boost).

Operation near the throttle trigger neutral position becomes a sharp rise.

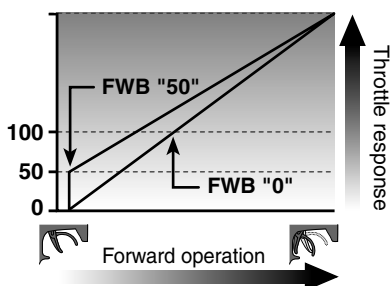

MC401,402CR

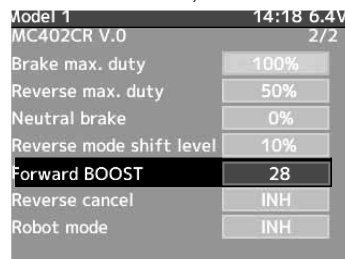

MC601,602,851C

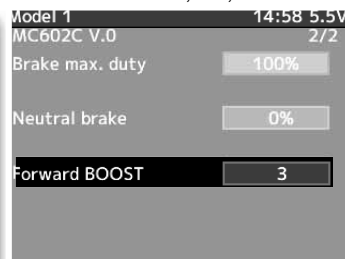

Reverse cancel

MC401,402CR/MC950CR/MC940,960CR :ACT/INH

Same as Link software Reverse Cancel.

When set to "ACT", reverse operation is not performed.

Robot mode

MC401,402CR/MC950CR/MC940,960CR :ACT/INH

Same as Link software Robot Model.

When set to "ACT", breke operation is not performed, there is only forward and reverse operation.

MC401,402CR		MC940,960CR		MC950CR	
Model 1	14:18 6.4V	Model 1	14:55 5.5V	Model 1	14:55 5.5V
MC402CR V.0	2/2	MC960CR V.17	3/4	MC960CR V.17	3/4
Brake max. duty	100%	BEC voltage	6.0V	BEC voltage	6.0V
Reverse max. duty	50%	Reverse cancel	ACT	Reverse cancel	ACT
Neutral brake	0%	Robot mode	INH	Robot mode	INH
Reverse mode shift level	10%				
Forward BOOST	28				
Reverse cancel	INH				
Robot mode	INH				

Brake slope

MC940,960CR/ :0~300

Same as Link software Brake Slope.

This function adjusts the braking effect when the throttle was returned (throttle off). It cancels operation like that called engine brake of actual vehicles.

MC940,960CR	
Model 1	14:55 5.5V
MC960CR V.17	2/4
Brake max. duty	100%
Reverse max. duty	100%
Neutral brake	0%
Brake slope	0
Brake timer	0s
Reverse mode shift level	10%
Power point A	1000rpm
Turbo mode	Turbo 0

Brake timer

MC940,960CR/MC950CR :0sec~300sec

Same as Link software Brake Timer.

When the reverse function is used, ordinarily if the trigger is not moved to the brake (reverse) side and then returned from the brake operation position to the neutral position, reverse operation will not be performed. However, when used by intentionally moving the neutral point to the forward side, if brake operation is repeated, reverse operation may be performed even if the trigger is not returned to the neutral position. The time required to switch to reverse operation can be set to prevent this from occurring.

MC940,960CR/MC950CR	
Model 1	14:55 5.5V
MC960CR V.17	2/4
Brake max. duty	100%
Reverse max. duty	100%
Neutral brake	0%
Brake slope	0
Brake timer	0s
Reverse mode shift level	10%
Power point A	1000rpm
Turbo mode	Turbo 0

Lead angle

MC950CR/ :0~1500

Same as Link software Lead Angle.

The lead angle of the motor can be set at the MC950CR side. However, we recommend that it normally be set to "0". Since this setting is premised on setting by referring to the speed log by the Link software.

MC950CR	
Model 1	14:56 5.5V
MC950CR V.1	2/3
Brake max. duty	100%
Reverse max. duty	100%
Neutral brake	0%
Boost	0
Brake timer	0s
Reverse mode shift level	10%
Lead angle	0

BEC voltage

MC940,960CR/ :6.0V/7.4V

Same as Link software BEC Volt.

The receiver BEC voltage can be selected from 6.0V and 7.4V. Match the voltage to the rating of the servo connected to the same receiver. This BEC voltage cannot output a voltage higher than the input voltage.

For instance, if a 6.0V receiver and servo are used with a power supply voltage of 7.4V or more, set the BEC voltage to 6.0V and when a high voltage receiver and servo are used, set the BEC voltage to 7.4V.

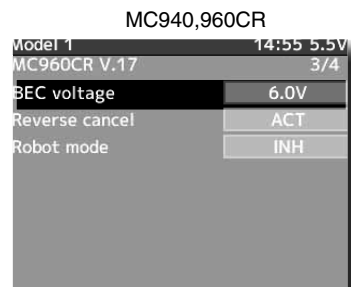

MC940,960CR	
Model 1	14:55 5.5V
MC960CR V.17	3/4
BEC voltage	6.0V
Reverse cancel	ACT
Robot mode	INH

Turbo mode

MC940,960CR/ :Turbo0/Turbo1/Turbo2

Same as Link software Turbo Mode.

This function sets the turbo mode. More power can be displayed by using the turbo mode. Depending on the setting, the motor and ESC may be damaged so make this setting carefully.

(Note) When "Lead angle use" is INH, lead angle setting will not operate even if set to "Turbo1" or "Turbo2." (Turbo mode disabled, Turbo0=Off)

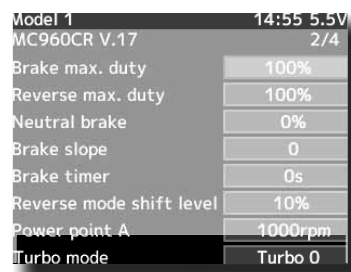

MC940,960CR	
Model 1	14:55 5.5V
MC960CR V.17	2/4
Brake max. duty	100%
Reverse max. duty	100%
Neutral brake	0%
Brake slope	0
Brake timer	0s
Reverse mode shift level	10%
Power point A	1000rpm
Turbo mode	Turbo 0

-Turbo0 mode: (No Lead Angle mode) Lead angle - No

When used in races in which the lead angle setting function is inhibited by ESC, set to this mode. The lead angle function is disabled the same as if "Lead angle use" was turned off.

When the lead angle function was disabled by the method described above, the MC940,960CR shows that the lead angle function is off by blinking a blue LED at an ON 0.1 second, OFF 0.9 second cycle at the neutral point.

-Turbo1 turbo mode: (Lead Angle mode) Lead angle – Yes

The output can be increased by setting a lead angle.

Depending on the set value, the motor may be damaged so increase the lead angle value in steps from a small value while observing the conditions.

Turn on "Lead angle use" and adjust the lead angle by "Lead angle" and point A, B, C, D, E (A, B, C, D, E Lead angle) value.

-Turbo2 power mode: (Power Mode) Lead angle – Yes

Displays still more power than a turbo.

However, since even a motor applies a large load on the ESC, make the lead angle larger in steps from a small value while observing the conditions.

Turn on "Lead angle use" and adjust the lead angle by "Lead angle" and point A, B, C, D, E (A, B, C, D, E Lead angle) value.

Power point A

MC940,960CR/ :0rpm~10000rpm

Same as Link software Power Point A.

When the turbo mode is power 2 (Power mode) and the lead angle is large, movement may become stiff when entering the course, etc. In this case, make operation smooth by lowering the set speed at power point A.

This function is not performed in modes other than Turbo 2.

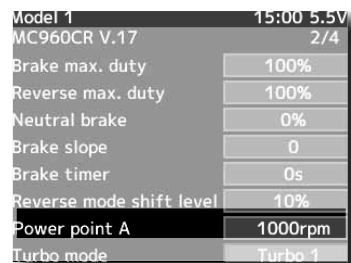

MC940,960CR	
Model 1	15:00 5.5V
MC960CR V.17	2/4
Brake max. duty	100%
Reverse max. duty	100%
Neutral brake	0%
Brake slope	0
Brake timer	0s
Reverse mode shift level	10%
Power point A	1000rpm
Turbo mode	Turbo 1

Lead angle use

MC940,960CR :ACT/INH

Same as Link software Lead Angle Use.

This function is effective when Turbo Mode is Turbo1 or Turbo2 and sets whether or not lead angle is used. This setting has priority over the Turbo Mode setting. When using in races in which the lead angle function is inhibited by the ESC set this function to INH.

INH : Lead angle function not used.

ACT : Lead angle used

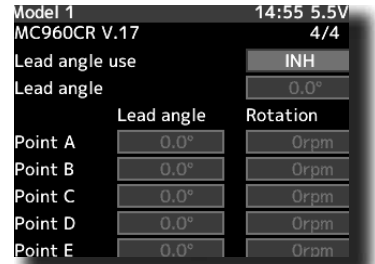

Turn on "Lead angle use"

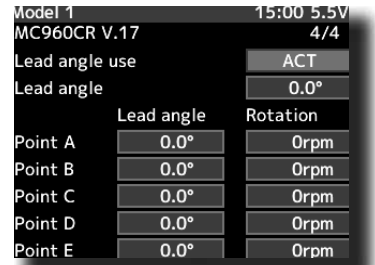

Lead angle

MC940,960CR :0deg~59deg

Same as Link software Lead Angle.

When "Lead Angle Use" is turned on the motor lead angle can be set at the MC960CR. The lead angle can be set up to 59 degrees in 1 degree increments.

Point A,B,C,D,E Lead angle

MC940,960CR :0deg~59deg

Same as Link software Boost Angle.

Point A,B,C,D,E Rotation

MC940,960CR :0rpm~9999rpm

Same as Link software Boost Angle rpm.

When "Lead Angle Use" is turned on the lead angle versus motor speed of the 5 points A to E can be set. The lead angle can be set up to 59 degrees in 1 degree increments.

The "Lead angle" and "Point A, B, C, D, E Lead angle" relationship is shown on the graphs below. Graph [1] shows the relationship when the same value is set at "Points A, B, C, D, E Lead angle" of [1] and [2] and the "Lead angle" was set to "0" and graph [2] shows the relationship when a value other than "0" was set at "Lead angle". As shown in the graphs, [2] is added to the "Points A, B, C, D, E Lead angle" set lead angle and [1] is added to the "Lead angle" set lead angle. For example, if "3" is set at Point A and "Lead angle" of [2] is set to "2", the actual Point A becomes $3+2=5$ (deg). Since "Lead angle" of [A] is "0", the actual Point A also becomes $3+0=3$ (deg).

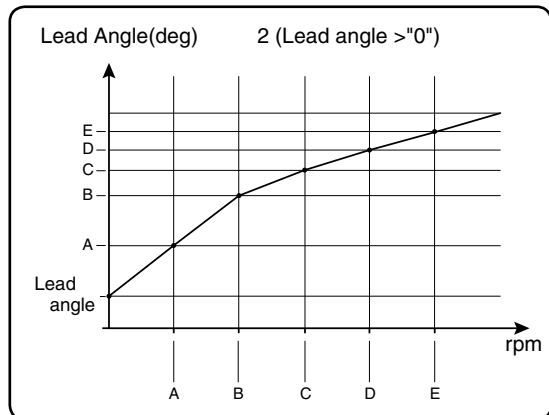
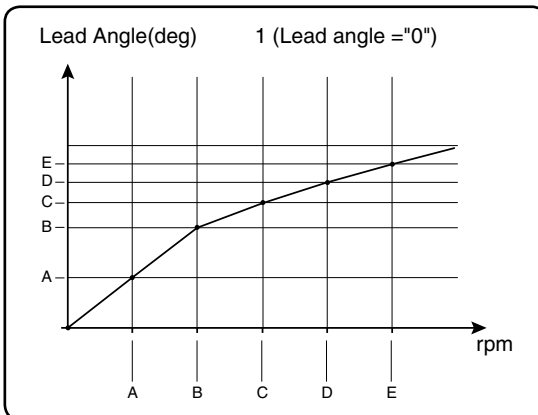

When using in races in which the lead angle setting function is inhibited by the ESC, set "Lead angle use" to "INH". The "Lead angle use" setting has priority over "Turbo mode". If "Lead angle use" is set to "INH", the lead angle setting function can be turned off even if "Turbo mode" is set to "Turbo1" or "Turbo2".

The MC940,960CR shows that the lead angle setting function is OFF ("0" timing) by blinking a LED.

S.Bus Servo

This is a special function which allows Futaba S.BUS/S.BUS2 servo parameter changes to be set by the T4X transmitter.

However, some data changes require a PC and S-Link software.

This function is used by connecting Futaba S.BUS/S.BUS2 servo directly to the transmitter.

Use the various optional servo extension cords according to the distance between the transmitter and servo.

-When the T4PX battery voltage drops, since the display switches to low battery display, use this function in the state in which the remaining battery charge is sufficient.

-Power is supplied to the servo from the transmitter, but the corresponding voltage is for high voltage servo (HV) use. Since an overvoltage will be applied to servos other than this, connect the corresponding battery to the servo. When the battery is connected, the supply of power from the transmitter automatically stops.

⚠ Caution

- ❶ When connecting an S-BUS servo that does not support high voltage, connect a battery matched to the servo specifications.

High voltage servo support voltage is supplied from the transmitter. If a servo that does not support high voltage is connected, unreasonable force will be applied to the servo and will cause trouble.

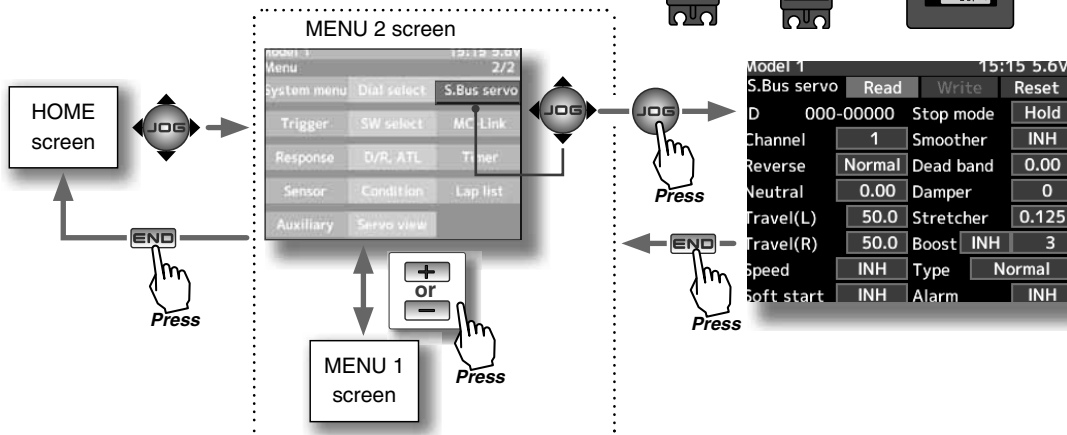
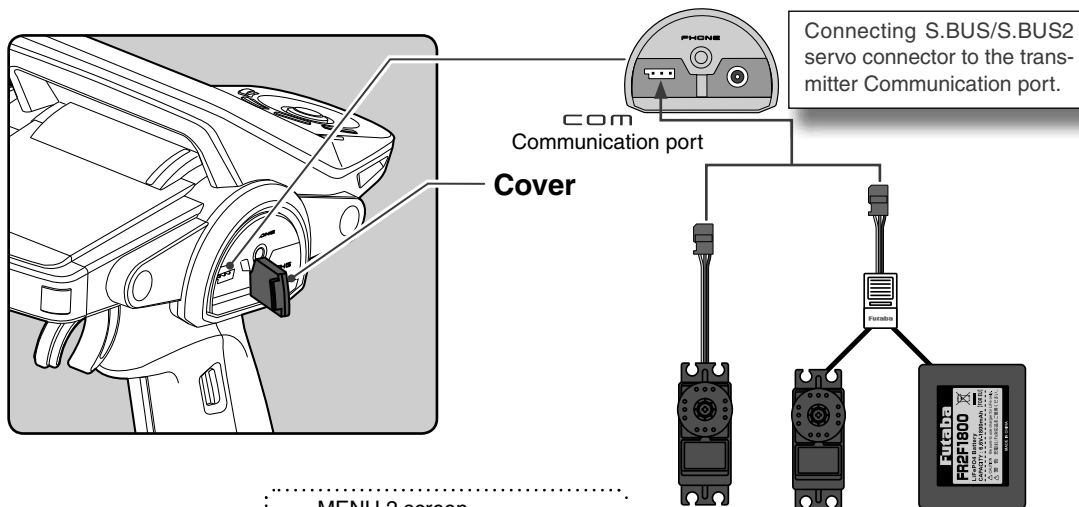

Function

Using the S.Bus servo function

(Preparation)

- Connect the T4PX and S.BUS or S.BUS2 servo in accordance with the connection diagram shown on page 126.
- Connect the battery to a non-high voltage(HV) support S.BUS/S.BUS2 servo.

1 Turn power on the transmitter. "S.Bus servo" menu is displayed referring to the map of page 126.

2 (S.BUS/S.BUS2 servo read)

Execute this function to read the connected servo type and the data currently set at the servo.

-Select the setting item "Read" by (JOG) button up or down operation, and press the (JOG) button.

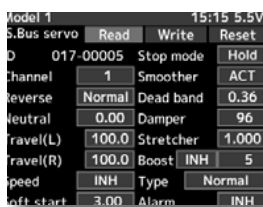
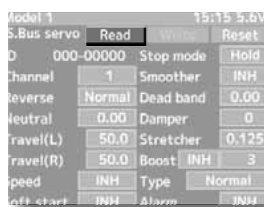

- "Reading succeeded" is displayed on the screen and the servo's ID cord and currently set contents are read.

- If "Failed" is displayed on the screen, communication with the servo is not being performed normally.

Check the T4PX and servo connection to servo and repeat "Read". (Connect the battery to a non-high voltage(HV) support servo.)

Setup item selection

- Select by (JOG) button up or down operation.

Reset execution button

- (JOG) buttons pressed.

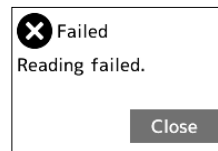
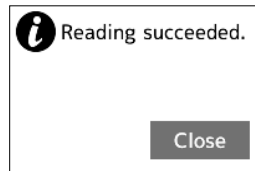

3 (Writing to S.BUS/S.BUS2)

Execute this function to write the setting data to servo. See pages 128~129 for the setting data contents.

-Select the setting item "Write" by (JOG) button up or down operation, and press the (JOG) button.

- "Writing succeeded" is displayed on the screen and the setting data is written to servo.

- If "Failed" is displayed on the screen, communication with the servo is not being performed normally. Check the T4PX and servo connection to servo and repeat "Write". (Connect the battery to a non-high voltage(HV) support servo.)

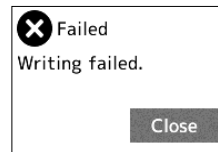
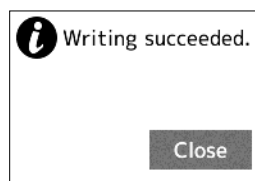
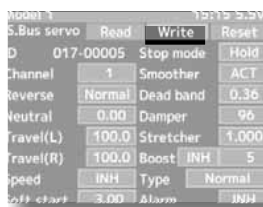

4 (Initialization)

Write the factory set servo setting data to the connected servo and T4PX.

-Select the setting item "Reset" by (JOG) button up or down operation, and press the (JOG) button.

- "Writing succeeded" is displayed on the screen and the setting data is written to servo.

- If "Failed" is displayed on the screen, communication with the servo is not being performed normally. Check the T4PX and servo connection to servo and repeat "Write". (Connect the battery to a non-high voltage(HV) support servo.)

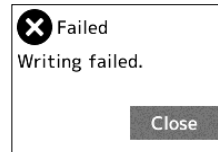
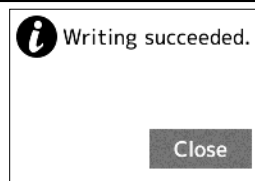
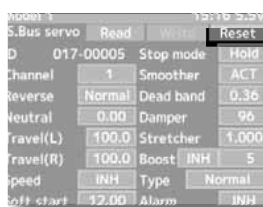

S.BUS function setup

(Preparation)

-S.BUS/S.BUS2 servo is read referring to the explanation of page 127.

- 1 Select the setting item by (JOG) button up, down, left, or right operation.
Set the value by (+) and (-) button.

ID

Displays the ID of the servo whose parameters are to be read. It cannot be changed.

Channel

This is the S.BUS system channel assigned to the servo. When connected to the receiver S-BUS2 connector as an S.BUS system, the channel used by the transmitter is assigned. When the normal receiver channel is used, channel setting is unnecessary.

Reverse

The direction in which the servo rotates can be changed.

Neutral

The neutral position can be changed. When the neutral offset is large value, the servo's range of travel is restricted on one side.

Travel(L)

The maximum left travels centered about the neutral position can be set independently.

Travel(R)

The maximum right travels centered about the neutral position can be set independently.

Speed

Speeds can be matched by specifying the operating speed. The speed of multiple servos can be matched without being affected by motor fluctuations. This is effective for load torques below the maximum torque.

However, note that the maximum speed will not be exceeded what the servo is capable of even if the servos operating voltage is increased.

Soft Start

Restricts operation in the specified direction the instant the power is turned on. By using this setting, the first initial movement when the power is turned on slowly moves the servo to the specified position.

Stop Mode

The state of the servo when the servo input signal is lost can be specified. The "Hold" mode setting holds the servo in its last commanded position even if using AM or FM system.

Smoother

This function makes servo operation smooth. Set it according to your taste. Normally set it to "ACT". Set it to "INH" when want especially quick operation. When the smoother function was set to "ACT" and the servo was operated the distance up to the target position is hanged in steps so movement is smooth.

Dead band

The dead band angle at stopping can be specified.

[Relationship between dead band set value and servo operation]

Small - Dead band angle is small and the servo is immediately operated by a small signal change.

Large - Dead band angle is large and the servo does not operate at small signal changes.

(Note) If the dead band angle is too small, the servo will operate continuously and the current consumption will increase and the life of the servo will be shortened.

Model 1		15:15 5.6V	
S.Bus servo	Read	Write	Reset
ID	000-00000	Stop mode	Hold
Channel	1	Smoother	INH
Reverse	Normal	Dead band	0.00
Neutral	0.00	Damper	0
Travel(L)	50.0	Stretcher	0.125
Travel(R)	50.0	Boost	INH 3
Speed	INH	Type	Normal
Soft start	INH	Alarm	INH

Damper

The characteristic when the servo is stopped can be set.

When smaller than the standard value, the characteristic becomes an overshoot characteristic. If the value is larger than the standard value, the brake is applied before the stop position.

Especially, when a large load is applied, overshoot, etc. are suppressed by inertia and hunting may occur, depending on the conditions. If hunting (phenomena which cause the servo to oscillate) occurs even though the Dead Band, Stretcher, Boost and other parameters are suitable, adjust this parameter to a value larger than the initial value.

[Relationship between damper set value and servo operation]

Small - When you want to overshoot. Set so that hunting does not occur.

Large - When you want to operate so that braking is not applied. However, it will feel like the servo response has worsened.

(Note) If used in the hunting state, not only will the current consumption increase, but the life of the servo will also be shortened.

Stretcher

The servo hold characteristic can be set. The torque which attempts to return the servo to the target position when the current servo position has deviated from the target position can be adjusted.

This is used when stopping hunting, etc., but the holding characteristic changes as shown below.

[Relationship between stretcher and servo operation]

Small - Servo holding force becomes weaker.

Large - Servo holding force becomes stronger.

(Note) When this parameter is large, the current consumption increases

Boost/Boost (ON/OFF)

INH : It is the boost ON at the time of low-speed operation.(In the case of usual)

ACT : It is always the boost ON.(When quick operation is hope)

The minimum current applied to the internal motor when starting the servo can be set. Since a small travel does not start the motor, it essentially feels like the dead band was expanded. The motor can be immediately started by adjusting the minimum current which can start the motor.

[Relationship between boost set value and servo operation]

Small - Motor reacts to a minute current and operation becomes smooth.

Large - Initial response improves and output torque increases. However, if the torque is too large, operation will become rough.

Type

When "Retractable" is selected and the servo has been continuously stopped for 30 seconds, the dead band expands and unnecessary hold current due to external force is eliminated. When a new control signal enters, normal operation is resumed. When using the servo as a landing gear servo, select "Retractable". Also adjust the servo travel to match the landing gear movement range.

Alarm

When the power supply of a servo is previously turned on at the time of a power supply injection without taking transmit of a transmitter, the buzzer sound of about 2.5 Hz continues sounding from a servo.

(Even when the transmit of a transmitter is taken out previously, a buzzer becomes until the signal of a servo is outputted normally, but it is not unusual.)

The transmitter has been turned OFF ahead of a servo power supply The buzzer sound of about 1.25 Hz continues sounding as servo power supply end failure alarm.

(Do not insert or remove the servo connector while the receiver power is ON. A buzzer may sound by incorrect recognition.)

*Buzzer sound is generated by vibrating the motor of a servo.

Since current is consumed and a servo generates heat, please do not operate the number more than needed or do not continue sounding a buzzer for a long time.

Telemetry System

With the telemetry system, the running status can be displayed at the transmitter and also recorded as a data log by installing various sensor units to the chassis

(The S-FHSS and FASST systems do not have a telemetry function.)

-The sensor data can be checked at the transmitter by connecting the telemetry sensor sold separately to the S.BUS2 connector of the R304SB receiver.

-To log this information, a start/stop switch is set by switch setting (p.99).

The log data recorded on a microSD card can be converted to CSV format by the telemetry log converter released at our home page. When copying or moving the log file, always select both .FLI and .FLD files.

-The figure is an example of connection of a telemetry sensor. The data of up to the following 3 types of sensor and the receiver power supply voltage can be transmitted by using the 3-way extension cord or double extension cord sold separately.

The receiver power supply can also be connected to the S.BUS2 connector or CH1~4 connector. A receiver power supply voltage sensor is unnecessary.

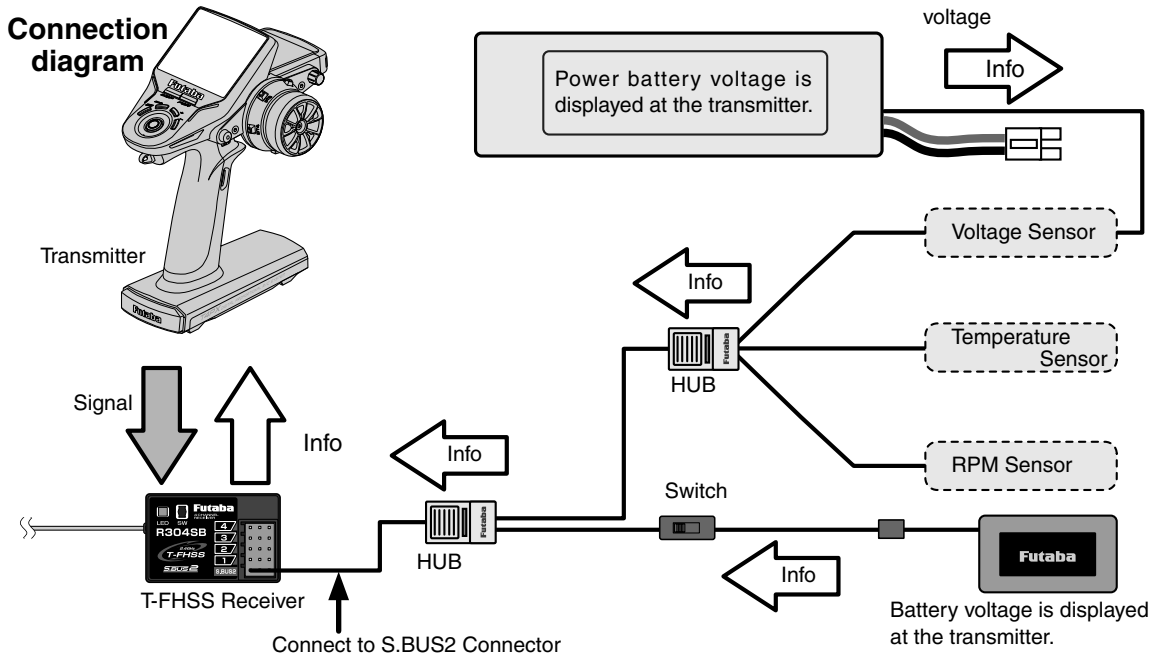

What is a slot?

Servos are classified by channel and sensors are classified by "slot". Since the T4PX initial slot No. is set at each sensor in advance, they can be connected as is. There are 31 slots numbered 1 to 31.

*When sensors over the initial setting (use of multiple sensors of the same type) are used, they must be registered at the sensor menu (p.138).

-Usable sensor options(As of June 2014)

*Temperature sensor (SBS-01T) Perfect for engine head, etc.

*Temperature sensor (SBS-01TE) Used by attaching to a motor, etc.

*RPM Sensor (SBS-01RM) Measures speed over the 0 to 999,900rpm range.

*Voltage Sensor (SBS-01V) Measures external power supply voltages up to 100V.

Telemetry Menu

It is necessary to turn on the telemetry on the receiver setting screen to use the telemetry function. (p.46)

This screen displays and sets the various information from the receiver. An alarm and vibration can be generated depending on the information. The alarm and the vibration are set by each information screen. For example, a drop in the voltage of the receiver battery housed in the model car can be reported by an alarm.

The telemetry data received last is memorized. Therefore, even if the receiver power is turned off, information display, audio guide, and alarms remain until the transmitter power is turned off.

The speech function can be turned on and off with the specified switch. See the function select switch function (p.99).

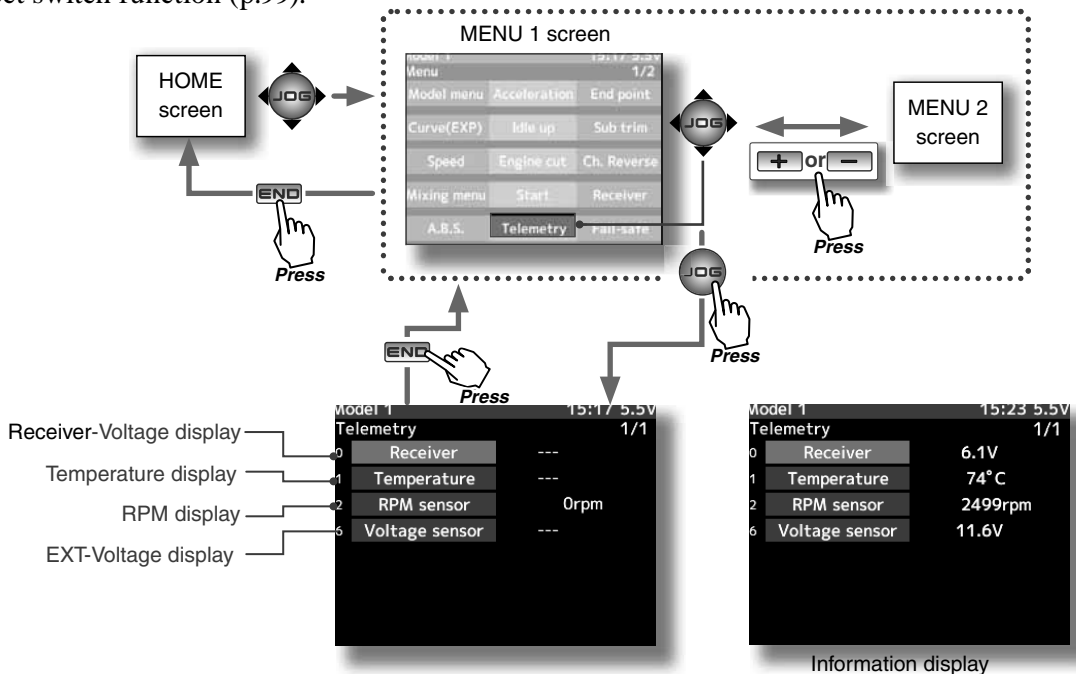

Using Telemetry function

(Preparation)

The sensor used is connected with the receiver referring to the connection diagram of page 130.

1 (Telemetry act)

The telemetry is turned on on the receiver setting screen.

(p.46)

It comes to be able to display telemetry information.

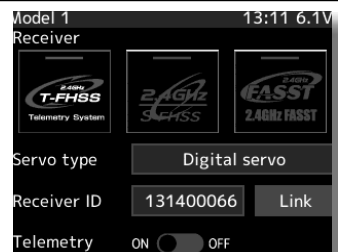

2 When ending setting, return to the menu screen by pressing the (END) button.

Each information is described in detail beginning from page132.

Telemetry :Receiver Battery

This function displays and sets the receiver power supply battery. The sensor sold separately does not have to be installed. The transmitter initial state voltage is also displayed. For a description of alarm setting when the voltage drops, see the description of the procedure on this page.

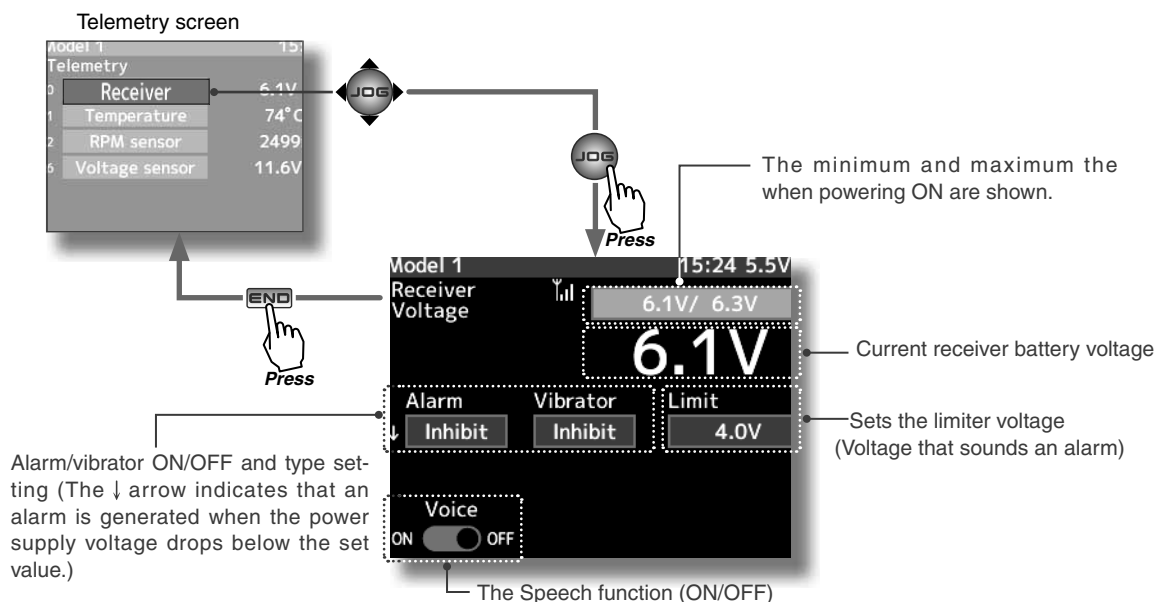

Alarm and Vibrator function setup

1 (Limit adjustment)

Select the setting item "Limit" by (JOG) button up, down, left or right operation.
Use the (+) or (-) button to adjust the limit voltage.

2 (Alarm and vibrator function setup)

Select the setting item "Alarm" by (JOG) button up, down, left or right operation. Set the function to the active state by pressing the (+) or (-) button.

- "Inhibit" :No audible alarm
- "Buzzer" :Audible alarm
- "Voice" :Voice alarm

Select the setting item "Vibrator" by (JOG) button up, down, left or right operation. Press the (+) or (-) button and select the type.

- "Inhibit" :No active vibration
- "Type1" :Continuous vibration
- "Type2" :Intermittent vibration for a long time
- "Type3" :Intermittent vibration for a short time

3 (Speech function setup)

Select the setting item "Voice" by (JOG) button up, down, left or right operation. Set the function to the active state by pressing the (+) or (-) button.

The voice guide loading interval is set by sensor menu.

- "OFF" :No voice guide
- "ON" :Information loaded by voice

4 When ending setting, return to the Telemetry menu screen by pressing the (END) button.

Telemetry :The Drive Battery

With an external power supply, one voltage of the batteries (drive battery, servo power supply battery, etc.) mounted separately in the chassis can be displayed at the transmitter. The receiver S.BUS2 connector is used to connect the SBS-01V sensor and the battery.

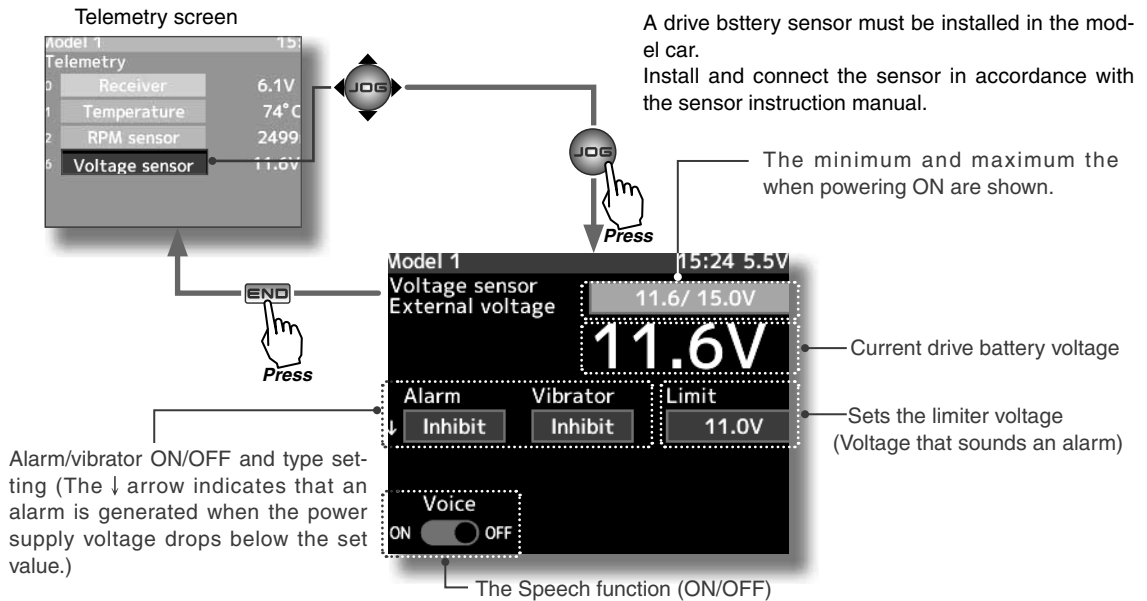

Alarm and Vibrator function setup

1 (Limit adjustment)

Select the setting item "Limit" by (JOG) button up, down, left or right operation.
Use the (+) or (-) button to adjust the limit voltage.

2 (Alarm and vibrator function setup)

Select the setting item "Alarm" by (JOG) button up, down, left or right operation. Set the function to the active state by pressing the (+) or (-) button.

- "Inhibit" :No audible alarm
- "Buzzer" :Audible alarm
- "Voice" :Voice alarm

Select the setting item "Vibrator" by (JOG) button up, down, left or right operation. Press the (+) or (-) button and select the type.

- "Inhibit" :No active vibration
- "Type1" :Continuous vibration
- "Type2" :Intermittent vibration for a long time
- "Type3" :Intermittent vibration for a short time

3 (Speech function setup)

Select the setting item "Voice" by (JOG) button up, down, left or right operation. Set the function to the active state by pressing the (+) or (-) button.

- "OFF" :No voice guide
- "ON" :Information loaded by voice

The voice guide loading interval is set by sensor menu.

4 When ending setting, return to the Telemetry menu screen by pressing the (END) button.

Telemetry :RPM

Speed information from an SBS-01RM (telemetry rotation sensor) sold separately is displayed and set at this screen. The speed of the engine, motor, etc. of the chassis while running can be viewed at the transmitter. When the speed becomes higher (lower) than the set speed, it can be announced by an alarm and vibration.

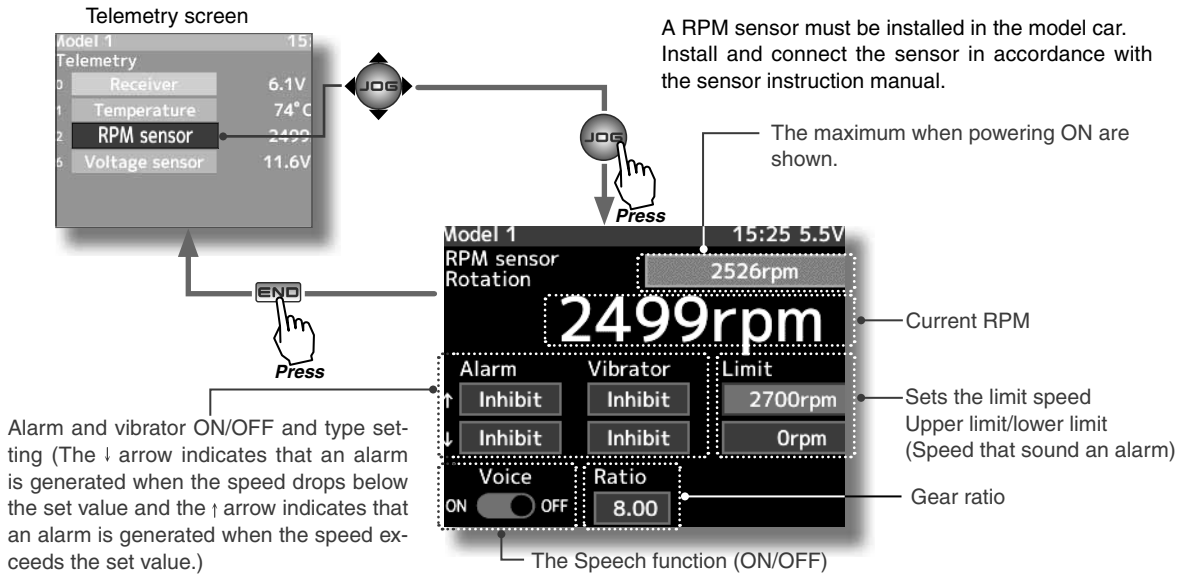

Alarm and Vibrator function setup

1 (Gear ratio setup)

Select the setting item "Ratio" by (JOG) button up, down, left or right operation. Use the (+) or (-) button to adjust the lgear ratio.

2 (Limit adjustment)

Select the setting item "↑ Limit" or "↓ Limit" by (JOG) button up, down, left or right operation. Use the (+) or (-) button to adjust the limit voltage.

3 (Alarm and vibrator function setup)

Select the setting item "↑ Alarm" or "↓ Alarm" by (JOG) button up, down, left or right operation. Set the function to the active state by pressing the (+) or (-) button.

"Inhibit" :No audible alarm / "Buzzer" :Audible alarm/ "Voice" :Voice alarm

Select the setting item "↑ Vibrator" or "↓ Vibrator" by (JOG) button up, down, left or right operation. Press the (+) or (-) button and select the type.

"Inhibit" :No active vibration/ "Type1" :Continuous vibration/ "Type2" :Intermittent vibration for a long time/
"Type3" :Intermittent vibration for a short time

4 (Speech function setup)

Select the setting item "Voice" by (JOG) button up, down, left or right operation. Set the function to the active state by pressing the (+) or (-) button.

"OFF" :No voice guide/ "ON" :Information loaded by voice

The voice guide loading interval is set by sensor menu.

5 When ending setting, return to the Telemetry menu screen by pressing the (END) button.

Telemetry :Temperature

This screen displays and sets the temperature information from an SBS-01T (telemetry temperature sensor) sold separately. The temperature of the engine, motor, amp, etc. of the chassis while running can be viewed at the transmitter.

When the temperature becomes higher (lower) than the set value, it can be announced by an alarm and vibration.

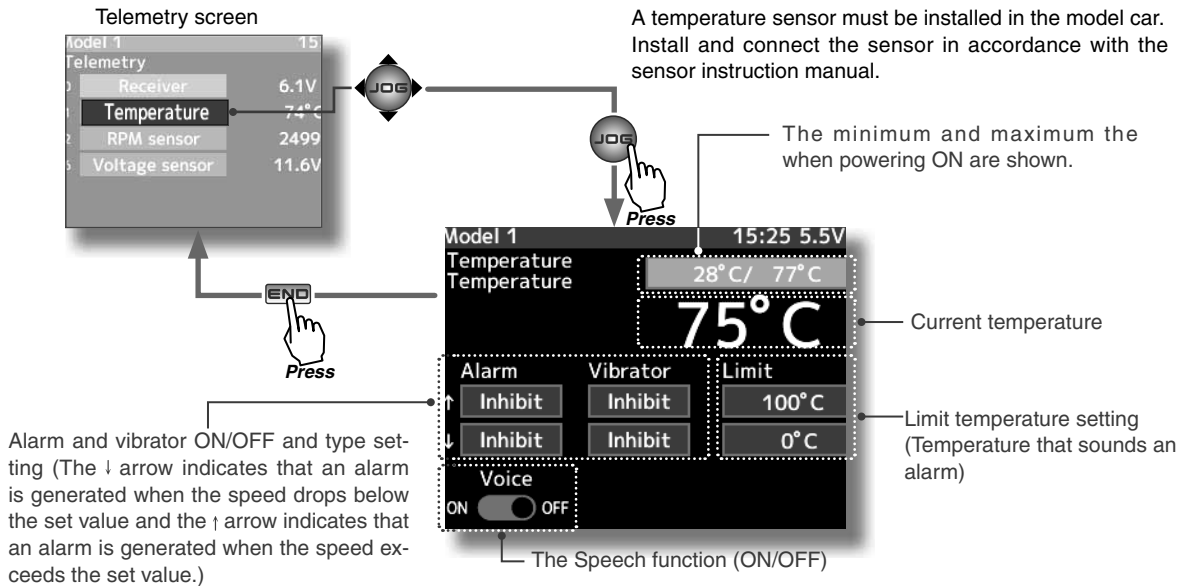

Alarm and Vibrator function setup

1 (Limit adjustment)

Select the setting item "↑ Limit" or "↓ Limit" by (JOG) button up, down, left or right operation. Use the (+) or (-) button to adjust the limit voltage.

2 (Alarm and vibrator function setup)

Select the setting item "↑ Alarm" or "↓ Alarm" by (JOG) button up, down, left or right operation. Set the function to the active state by pressing the (+) or (-) button.

"Inhibit" :No audible alarm / "Buzzer" :Audible alarm/ "Voice" :Voice alarm

Select the setting item "↑ Vibrator" or "↓ Vibrator" by (JOG) button up, down, left or right operation. Press the (+) or (-) button and select the type.

"Inhibit" :No active vibration/ "Type1" :Continuous vibration/ "Type2" :Intermittent vibration for a long time/ "Type3" :Intermittent vibration for a short time

3 (Speech function setup)

Select the setting item "Voice" by (JOG) button up, down, left or right operation. Set the function to the active state by pressing the (+) or (-) button.

The voice guide loading interval is set by sensor menu.

"OFF" :No voice guide

"ON" :Information loaded by voice

4 When ending setting, return to the Telemetry menu screen by pressing the (END) button.

Sensor Menu

This menu registers the telemetry sensors used with the transmitter. When only one of a certain type of sensor is used, this setting is unnecessary and the sensor can be used by simply connecting it to the S.BUS2 port of the transmitter.

When using 2 or more of the same kind of sensor, they must be registered here.

What is a slot?

Servos are classified by CH, but sensors are classified in units called "slot". There are slots from No. 1 to No. 31. Using a sensor which uses two or more slots, the required number of slots is automatically assigned by setting up a start slot. When 2 or more of the same kind of sensor are used, the sensors themselves must allocate unused slots and memorize that slot.

The interval at which the voice guide of the telemetry information is read and the interval at which the log data is recorded can be set at this screen.

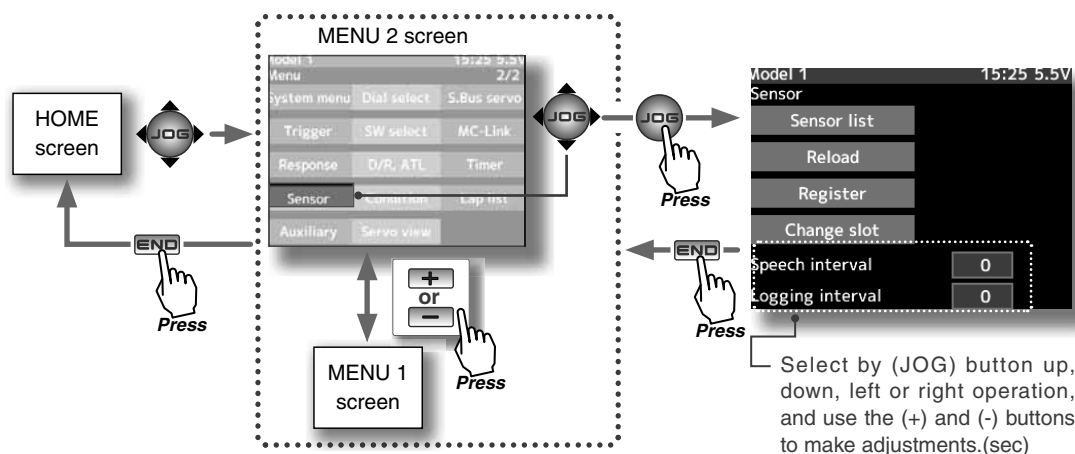

sensor	The required number of slots	The number which can be used as a start slot
TEMP(SBS-01T)	1 slot	1~31
RPM(SBS01RM)	1 slot	1~31
Voltage(SBS-01V)	2 slot	1, 2, 3, 4, 5, 6, 8, 9, 10, 11, 12, 13, 14, 16, 17, 18, 19, 20, 21, 22, 24, 25, 26, 27, 28, 29, 30

Function

Sensor List

The sensors registered at the T4PX are displayed. When sensor reloading, sensor registration, slot number change, etc. is performed, it is added to the list and the list is changed.

Adjustment buttons

- Use the (+) and (-) buttons to make adjustments.
- Return to the initial value by pressing the (+) and (-) buttons simultaneously (approx. 1 sec).

Interval
0 ~ 30sec
Initial value:0

Sensor menu screen

Sensor list

Sensor list		1/2
0	Receiver	8
1	Temperature	9
2	RPM sensor	10
3	----	11
4	----	12
5	----	13
6	Voltage sensor	14
7	Voltage sensor	15

When sensor registration or slot number change was performed and the message "Failed. The connected sensor is not ready." was displayed, check the sensor connection. If the sensor is firmly connected, the sensor or transmitter is probably faulty.

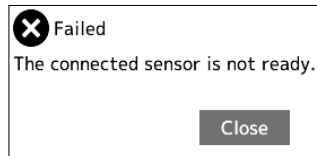

Sensor Reload

This function secures contiguous unused slots by rearranging the registration state when sensor registration and deregistration are performed repeatedly and the unused slots are fragmented.

All the sensors to be used are connected to the T4PX.

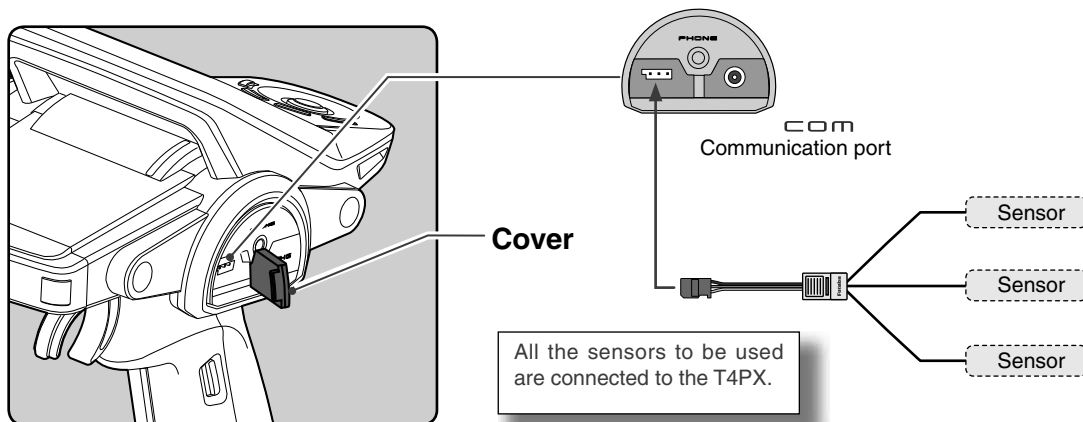

Sensor reload

1 (Reload)

Select "Reload" by (JOG) button up or down operation and press the (JOG) button. The confirmation message "Are you sure?" appears. To execute reload, select "Yes" and to cancel reload, select "No" with the (JOG) button and press the (JOG) button. If the message "Success" is displayed, reloading is complete.

Sensor menu screen

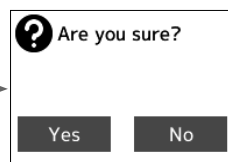
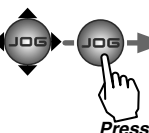

Setup item selection

- Select by (JOG) button up or down operation.

Reload button

- (JOG) buttons pressed.

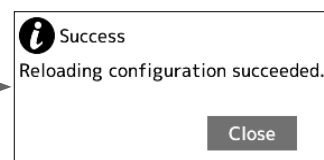

2 When ending setting, return to the Sensor menu screen by pressing the (END) button.

Sensor Register

This function registers an additional sensor. Connect the sensor as shown in the figure and register it by the following procedure. The sensor ID is registered in the transmitter.

This function is set when using multiple telemetry sensors of the same type.

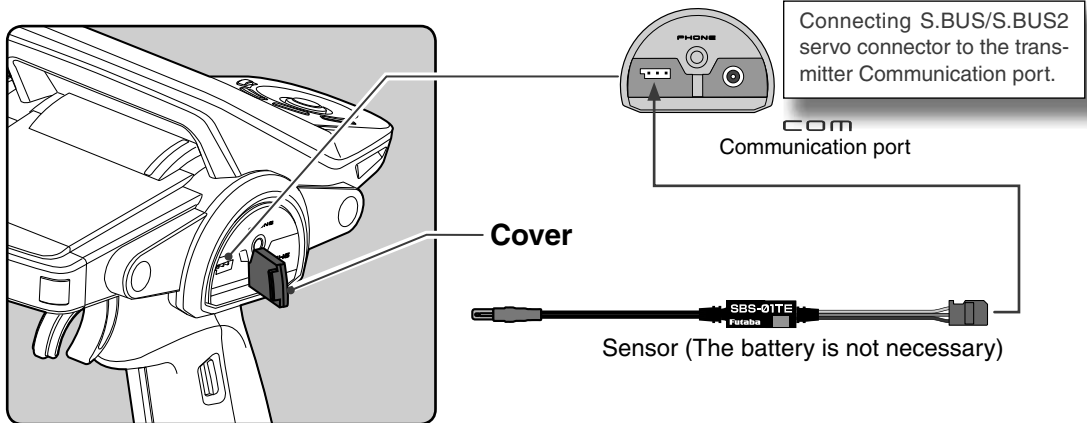

Sensor register

1 (Register)

Select "Register" by (JOG) button up or down operation and press the (JOG) button. The confirmation message "Are you sure?" appears. To execute registration, select "Yes" and to cancel registration, select "No" by (JOG) button and press the (JOG) button. If registering a sensor that has already been registered is attempted, the message "Failed" will be displayed.

Setup item selection

- Select by (JOG) button up or down operation.

Register button

- (JOG) buttons pressed.

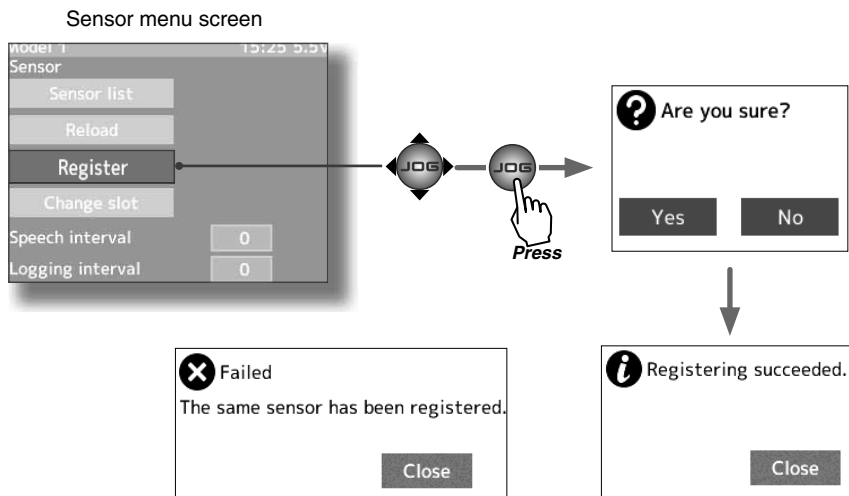

2 When ending setting, return to the Sensor menu screen by pressing the (END) button.

Change Slot

This procedure changes the slot number of one registered sensor. Connect the sensor as shown in the figure(p.138), and change slot number. it by the following procedure.

This function is set when using multiple telemetry sensors of the same type.

Sensor slot change

1 (Change)

Select "Slot No. change" by (JOG) button up or down operation and press the (JOG) button. A sensor details screen is displayed.

Setup item selection

- Select by (JOG) button up or down operation.

Select button

- (JOG) buttons pressed.

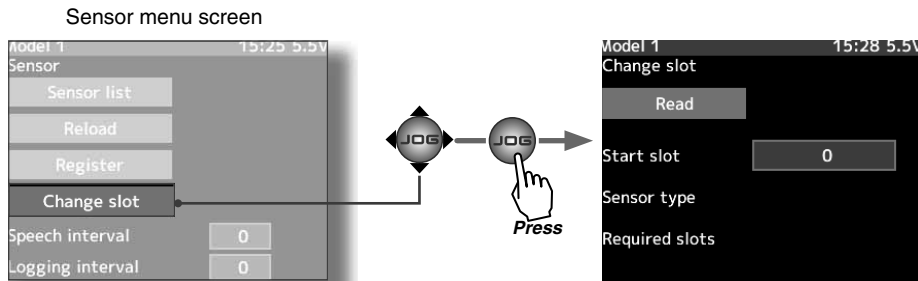

2 Select "Load" by (JOG) button up or down operation and press the (JOG) button. The message "Reading succeeded" appears and the current sensor information is displayed.

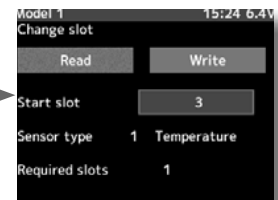
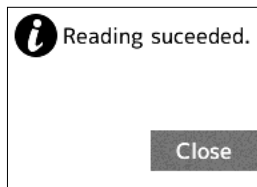

3 Select "Slot No." by (JOG) button up or down operation and set the new number by pressing the (+) or (-) button.

4 Select "Write" by (JOG) button up or down operation and press the (JOG) button. The message "Settings written" appears and number change is complete.

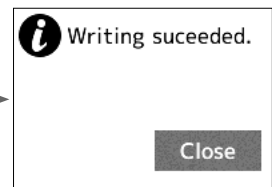

5 When ending setting, return to the Sensor menu screen by pressing the (END) button.

Condition Function

Two kinds of data can be set in one model for specific functions only; for example, two kinds of data such as steering D/R set to 90% at normal condition and steering D/R set to 80% at second condition. This second condition can be set for each model.

-The functions that can be set at each condition are displayed by condition number at the top of the menu screen. Since the reverse function, end point and other model standard setup menus are not displayed by conditioner number, the condition 1 and condition 2 settings are common.

- To use the condition function, switch setting by function select switch (p.99) is necessary.

- Switching from normal condition to second condition by switch set by function select switch is indicated by an audible alarm, and the condition number is displayed in the upper on the screen.

-First, the initial settings of each condition 2 function are created.

-The data set at condition 2 is memorized until reset by model reset (p.116). The data is memorized even if the condition function is turned off or setting of the SW by switch setting function is changed.

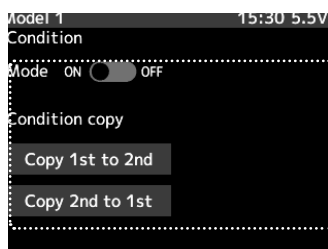
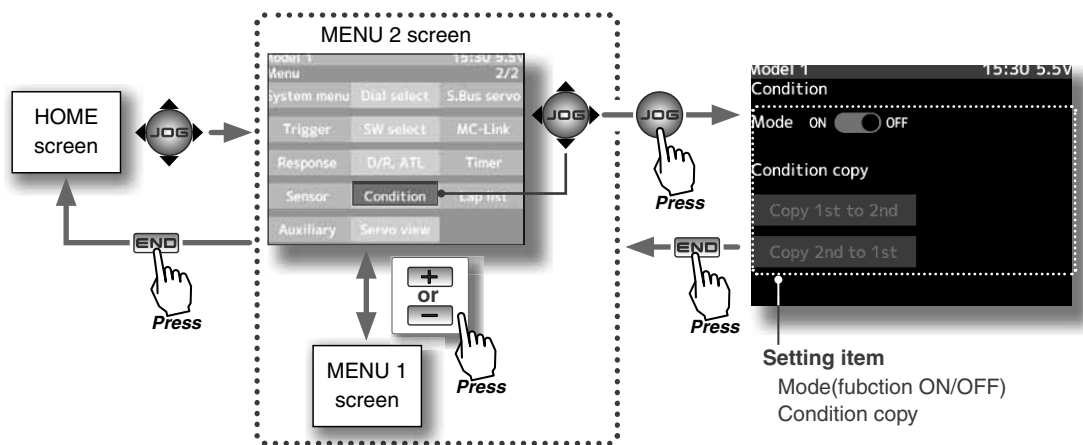

When the condition function is turned on, the condition copy display becomes active and the condition is enabled.

Condition setup

(Preparation)

- Use the function select switch function to select the switch. (p.99)

1 (Function ON/OFF)

Select the setting item "Mode" by (JOG) button up or down operation. Set the function to the active state by pressing the (+) or (-) button.

"OFF" :Function OFF
"ON" :Function ON

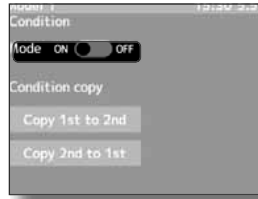

Setup item selection

- Select by (JOG) button up, or down operation.

Setup buttons

- Use the (+) or (-) buttons to make setup.

Function ON/OFF (Mode)
ON,OFF

Condition copy display becomes active and the condition can be used.

2 (Condition copy ON/OFF)

Select the condition copy direction by (JOG) button up or down operation. When copying from condition copy 1 to condition copy 2, select "2nd to 1st", and press the (JOG) button.

The confirmation message "Are you sure?" appears. To execute copy, select "Yes" and to cancel copy, select "No" and press the (JOG) button.



Copy selection

- Select by (JOG) button up, or down operation.

Setup buttons

- (JOG) buttons pressed.



3 When ending setting, return to the menu screen by pressing the (END) button.

Display when condition is used

The diagram illustrates the state of the device when a condition is used. It shows two screens connected by double-headed arrows. The top screen is the 'HOME screen' (Condition number 1) and the bottom screen is the 'Example D/R, ATL screen' (Condition number 2). The 'HOME screen' shows various parameters like 'Dual rate' at 100 and 'Brake1 rate(ATL)' at 100. The 'Example D/R, ATL screen' shows 'Dual rate' at 70 and 'Brake1 rate(ATL)' at 50. The transition is triggered by the condition number changing from 1 to 2.

Response Adjustment

The operation response can be adjusted to your preference and the steering and throttle can be individually adjusted in 50 steps to match the course and vehicle.

Basically, the standard fastest response is recommended. However, use this function when you want to change the response feeling. When this function is turned on, both the steering and throttle are switched from the standard fastest response to step 1 mild direction setting. The steering and throttle can be separately adjusted up to 50 steps in the mild direction based on this.

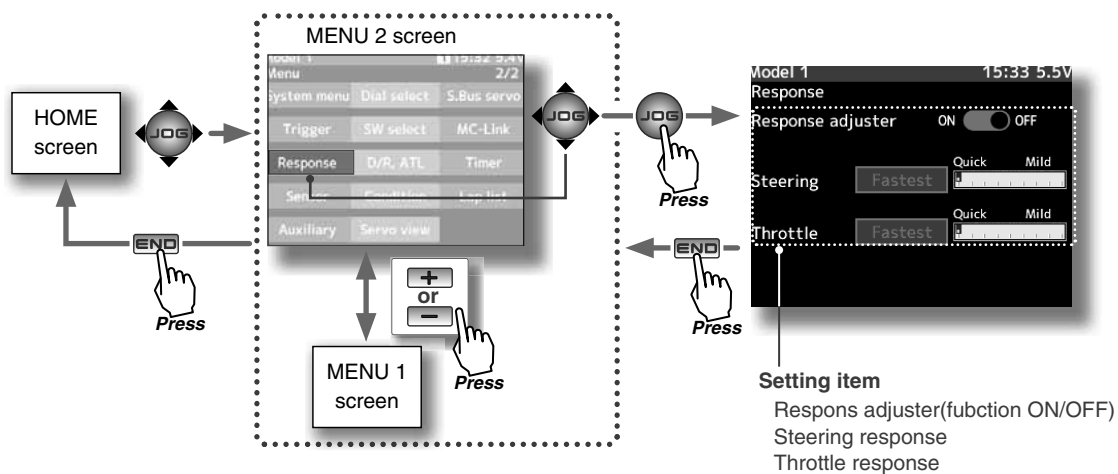

Response adjustment

1 (Function ON/OFF)
 Select the setting item "Response adjuster" by (JOG) button up or down operation. Set the function to the active state by pressing the (+) or (-) button.

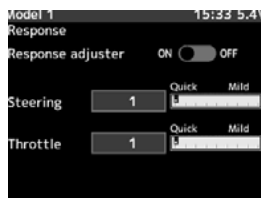

Setup item selection
 - Select by (JOG) button up, or down operation.

Setup buttons
 - Use the (+) or (-) buttons to make setup.

2 (Steering response)
 Select the "Steering" to be set by (JOG) button operation. When you want to milder steering response, use the (+) button to adjust the "+" side. When you want to make steering operation quicken use the (-) button to adjust the "-" side.

Adjustment buttons
 - Use the (+) and (-) buttons to make adjustments.
 - Return to the initial value by pressing the (+) and (-) buttons simultaneously (approx. 1 sec).

Ret: 1 ~ 50

3 (Throttle response)
 Select the "Throttle" to be set by (JOG) button operation. When you want to milder throttle response, use the (+) button to adjust the "+" side. When you want to make steering operation quicken use the (-) button to adjust the "-" side.

4 When ending setting, return to the menu screen by pressing the (END) button.

System Menu

The graphic liquid crystal screen display mode, sound, LED setting, date/time, user name, battery mode, calibration can be set and information.

The system function setup items cannot be set for each model. (Second condition can be set for each model.)

- Display

Liquid crystal screen backlighting display mode setup.
(OFF, ON at button operation, normally ON)

- Sound

Buzzer, soeoch voice sound volume adjustment.

- LED setting

LED display setup. (OFF, Link to LCD screen backlight setting)

- Battery

Select the battery alarm voltage according to the battery to be used.

Battery type setting (LiFe 2cells, NiMH 5cells, Other)

- User name

This function allows you to assign a 15 character to user name.

- Data and Time

Setting at date and time/ Setting of either time or total timer on HOME screen.

- Calibrattion

Use this function when a mechanical offset has occurred for some reason.

- Information

System program version information, and selection of language.

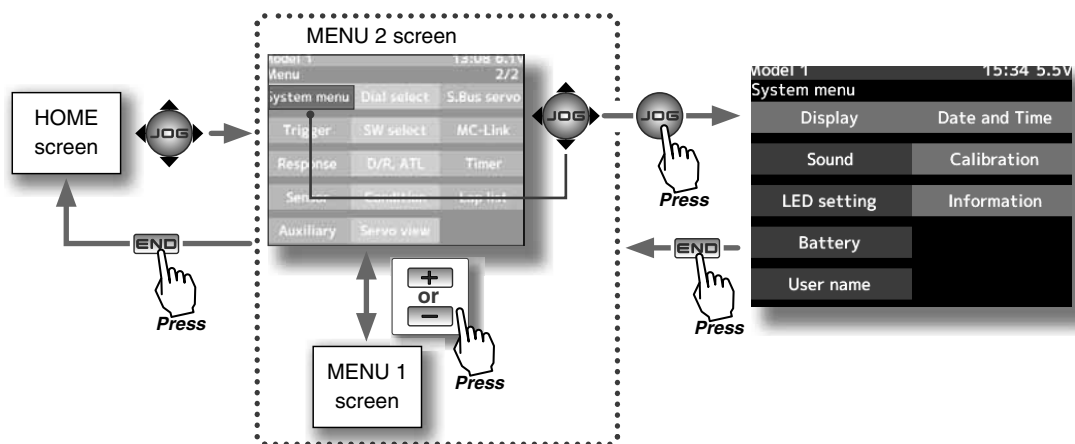

Each set screen is displayed from the system menu. Please refer to the following maps.

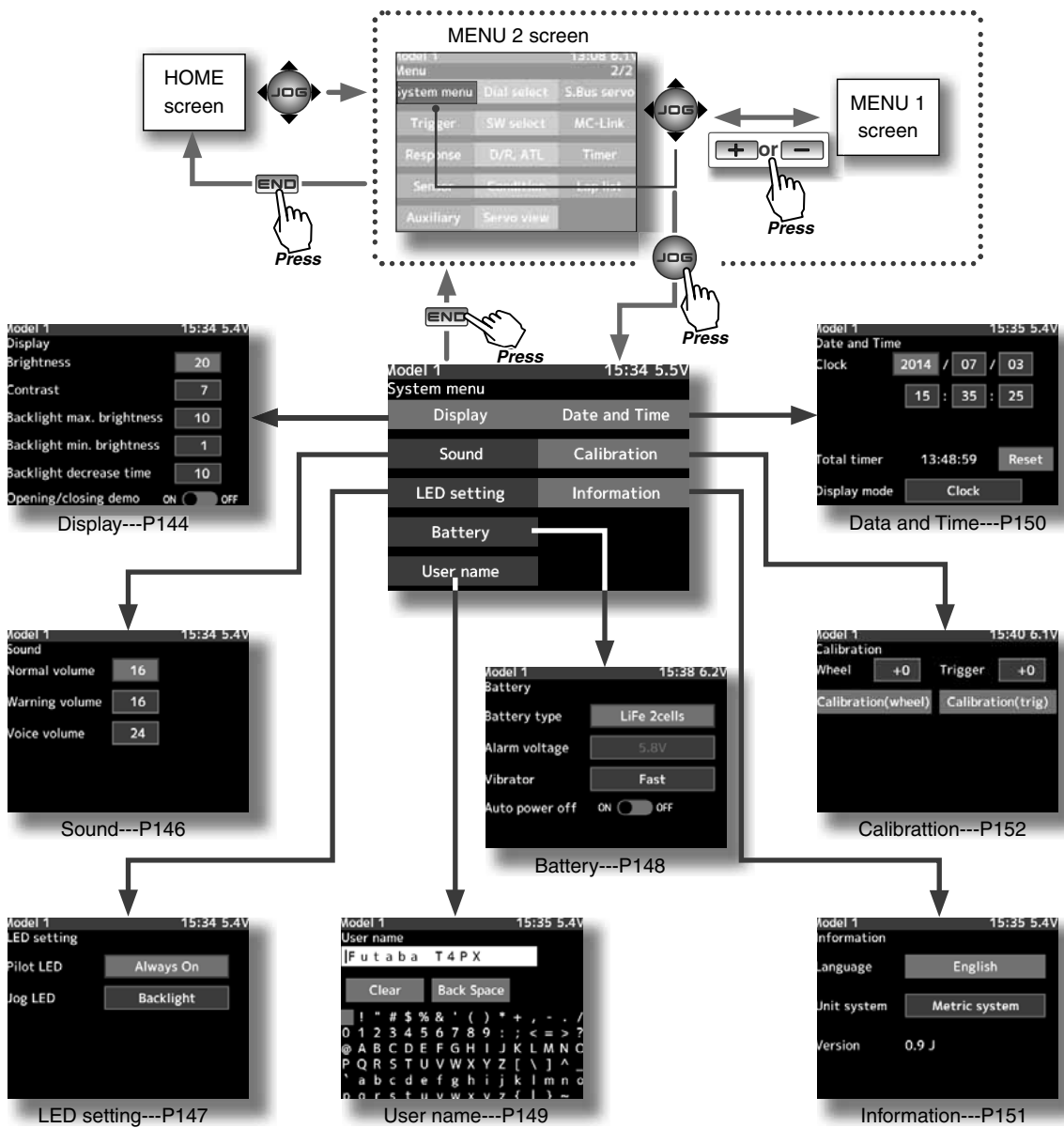

Function

Display setting

Brightness, contrast and back light mode adjustment LCD screen.

This setting is displayed from the screen of the system menu. (above figure)

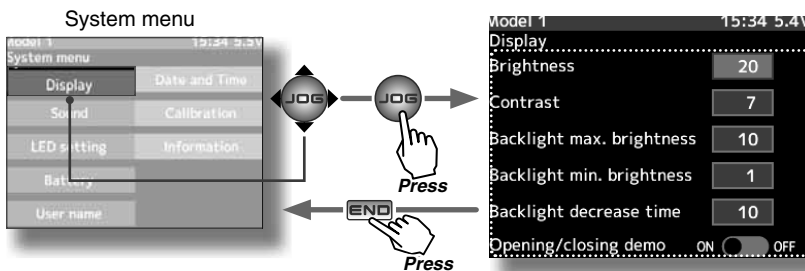

Setup item selection

- Select by (JOG) button up, or down operation.

buttons

- **Setup /Adjustment buttons**
- Use the (+) and (-) buttons to make adjustments.
- Return to the initial value by pressing the (+) and (-) buttons simultaneously (approx. 1 sec).

Display setup

1 (Adjusting the crystal brightness)
Select the "brightness" to be set by (JOG) button operation, and use the (+) and (-) buttons to adjust the screen brightness.

Brightness
0~63
Initial value: 20

2 (Adjusting the liquid crystal contrast)
Select the "Contrast" to be set by (JOG) button operation, and use the (+) and (-) buttons to adjust the screen contrast.

Contrast
0~15
Initial value: 8

3 (Backlight decrease brightness adjustment)
Select the "Backlight max, brightness" or "Backlight man, brightness" to be set by (JOG) button operation, Adjust the backlight decrease brightness with the (+) and (-) buttons.

Backlight decrease brightness
0~20
Initial value: max-10,min-1

4 (Backlight decrease time)
You can set a time period to decrease the LCD backlight. This function counts the period that the touch panel has been not operated. This time can be set by one second steps. You can also turn off the backlight decrease if you like.
Select the "Backlight decrease time", to be set by (JOG) button operation, and use the (+) and (-) buttons to adjust the backlight decrease time .

Backlight decrease time
NH, 1~240 sec
Initial value: max-10,min-1

5 (Setting of Opening/closing demo)
Whether or not the Futaba T4PX logo appears on the screen at starting and ending can be set. When set to OFF, the logo is not displayed.
Select the "Opening/closing screen" to be set by (JOG) button operation, and use the (+) and (-) buttons to select the display mode.

Demo csreen
ON/OFF
Initial value:ON

6 When ending setting, return to the system menu screen by pressing the (END) button.

Sound Setting

This function can set the volume of "Key Operation", "Warning" and "Telemetry speech info".

-The volume of the click when edit key, jog, and trim are operated can be adjusted.

-The volume of the audible alarm sound can be adjusted.

-When the telemetry function is used, the volume of the voice that announces the temperature, speed, voltage, and other information at a fixed interval can be adjusted.

This setting is displayed from the screen of the system menu. (p.144)

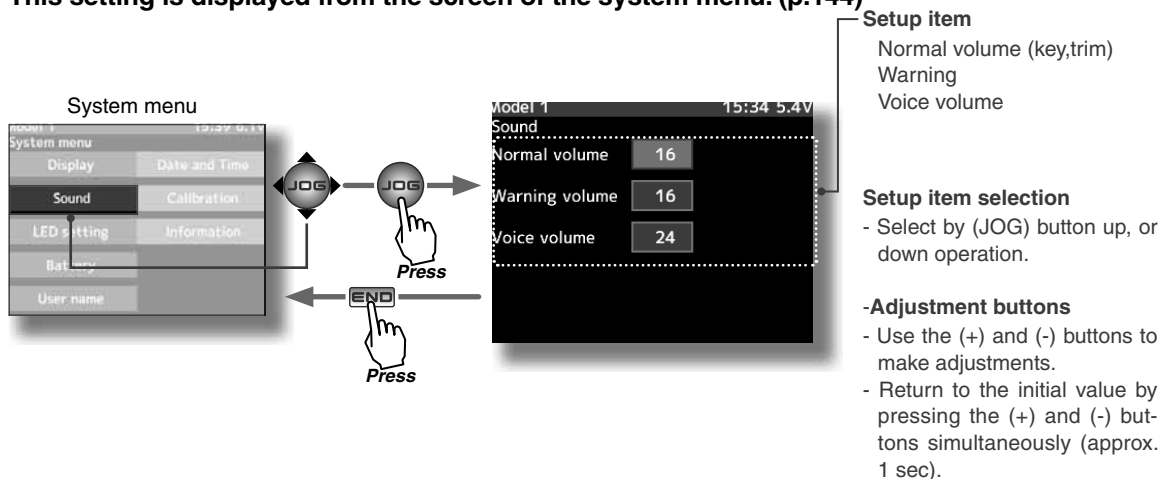

Volume adjustment

1 (Adjusting the key operation volume)

Select the "Normal volume" to be set by (JOG) button operation, and use the (+) and (-) buttons to adjust the volume.

Normal volume
0~32
Initial value: 16

2 (Adjusting the warning volume)

Select the "Warning volume" to be set by (JOG) button operation, and use the (+) and (-) buttons to adjust the volume.

Warning volume
1~32
Initial value: 16

3 (Adjusting the voice volume)

Select the "Voice volume" to be set by (JOG) button operation, and use the (+) and (-) buttons to adjust the volume.

Voice volume
0~32
Initial value: 16

4 When ending setting, return to the system menu screen by pressing the (END) button.

LED Setting

The method of lighting the pilot LED light and job LED light can be adjusted.

-Pilot LED always on, off.

-Jog LED always on, off, linked with backlighting.

This setting is displayed from the screen of the system menu. (p.144)

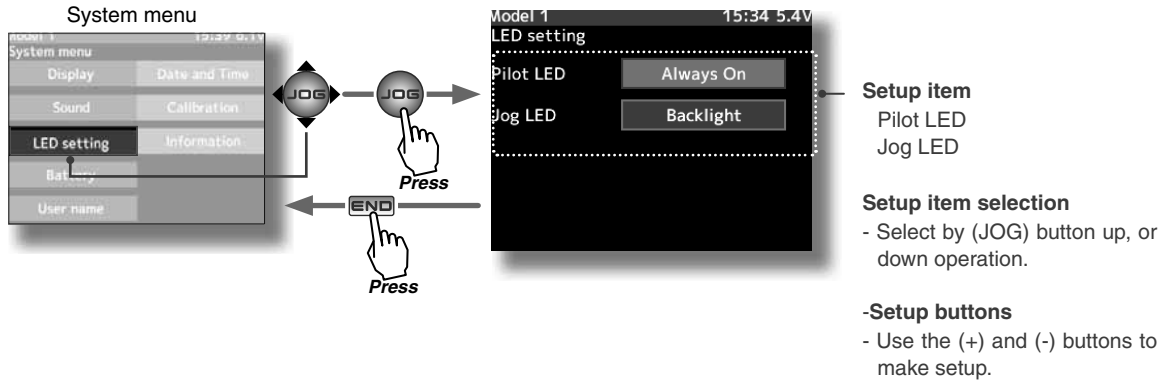

LED setting

1 (Setting pilot LED)

Select the "Pilot LED" to be set by (JOG) button operation, and use the (+) and (-) buttons to select the LED mode.

Pilot LED mode
Always On, OFF

2 (Setting Jog LED)

Select the "Jog LED" to be set by (JOG) button operation, and use the (+) and (-) to select the LED mode.

Jog LED mode
Backlight, Always On, OFF

3 When ending setting, return to the system menu screen by pressing the (END) button.

Battery Type Setting

With the T4PX, the low battery alarm setting is different, depending on the type of battery. Therefore, always set the battery type matched to the power supply to be used. When using a Futaba rechargeable type battery, always select "LiFe 2 cells" or "NiMH 5 cells". Incorrect setting will substantially shorten the time from low battery alarm to system stopping and is very dangerous.

Exceptionally, when using a battery other than this, select "Other" and set the low battery alarm voltage on your own responsibility. Futaba is not responsible for trouble caused by use of an unspecified battery.

This setting is displayed from the screen of the system menu. (p.144)

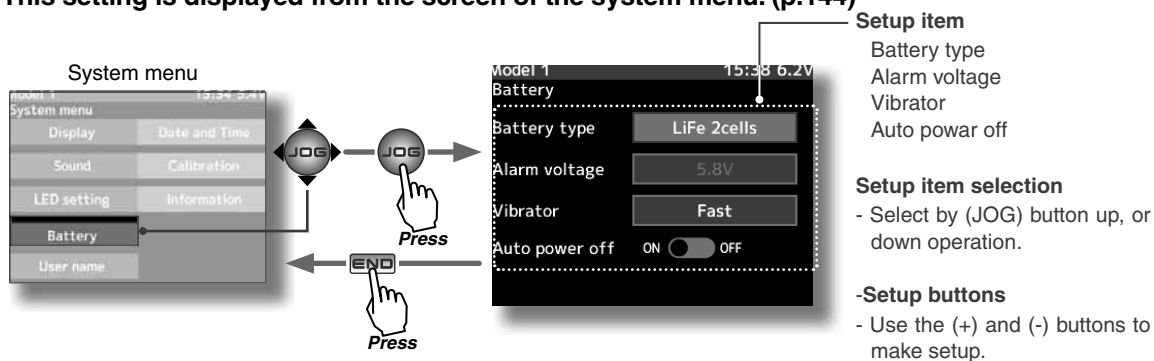

Battery setting

1 (Select battery type)

Select the "Battery type" to be set by (JOG) button operation, and use the (+) and (-) buttons to select the attery type.

Battery type

LiFe 2cells, NiMH 5cells, Other

2 (Setting low bwtttery alarm voltage)

When a specified battery was set by battery type, the alarm voltage is automatically set and cannot be adjusted. When "Other" was set by battery type, set the alarm voltage yourself. Select the "Alarm voltage" to be set by (JOG) button operation, and use the (+) and (-) to adjust the volutage.

Alarm voltagre (Other battery)

4.2V~8.0V

Initial value: 4.2V

3 (Select vibrator type)

Select the "Vibrator" to be set by (JOG) button operation, and use the (+) and (-) buttons to select the Vibrator type.

Vibrator tyape

Inhibit, Continuous, Slow, Fast

Select the vibrator type from among Inhibit, Continuous, Slow, and Fast. When vibration is not linked with the battery alarm, select "Inhibit".

Auto power off

ON, OFF

4 (Auto power off sertting)

Select the "Auto power of" to be set by (JOG) button operation. Set the function to the active state by pressing the (+) or (-) button.

5 When ending setting, return to the system menu screen by pressing the (END) button.

User Name

This function allows you to assign a 15 character name to each user name.

This setting is displayed from the screen of the system menu. (p.144)

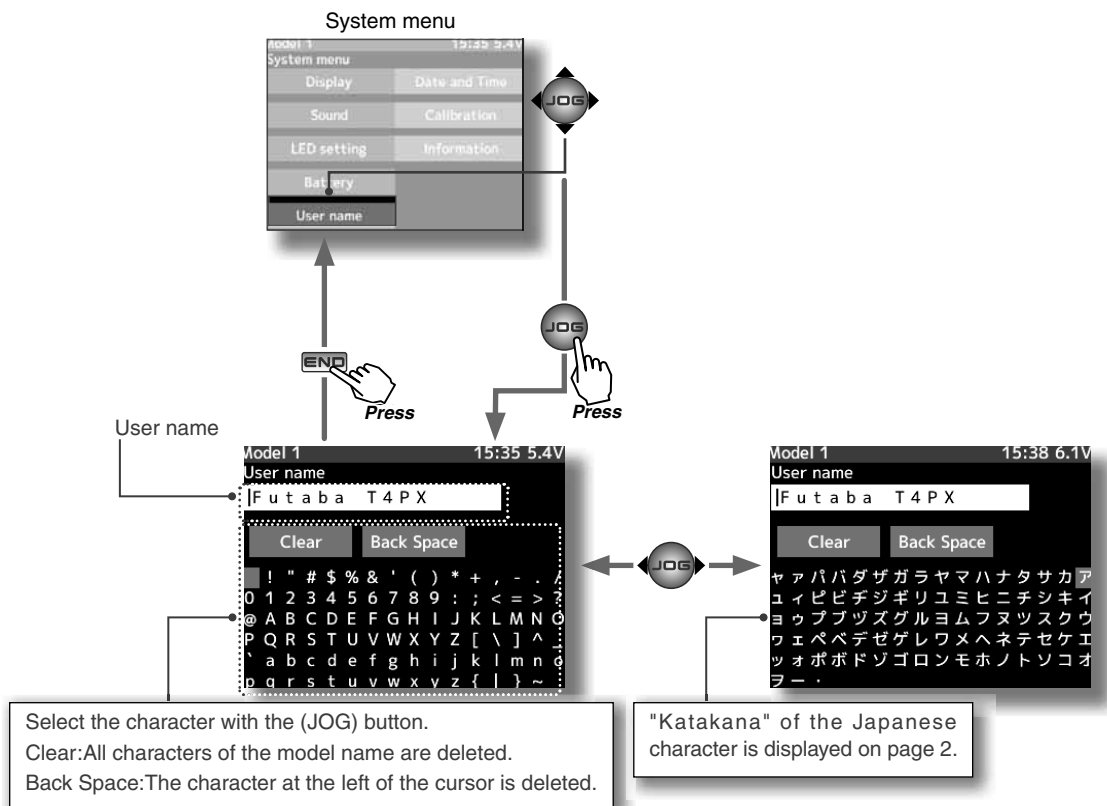

Setting the user name

- 1** (Moving the cursor to the character you want to change.)
"Move the cursor to the user name character you want to set or change by pressing the (+) or (-) button. The selected character blinks.
- 2** (Selecting the character to be used)
Move the cursor by (JOG) button up, down, left, or right operation, and select the characters to be used from the character list at the bottom of the screen. After deciding the characters to be used, press the (JOG) button. The characters are selected and the user name character string moves to the right. When "Back space" on the center row is selected and the (JOG) button is pressed, the character at the left of the vertical cursor is deleted. When "Clear" is selected and the (JOG) button is pressed, all the characters are deleted.
- 3** When ending setting, return to the system menu screen by pressing the (END) button.

Character select/set button

- Select the character by (JOG) button up, down, left, or right operation and enter the character by pressing the (JOG) button.

Data And Time

This function adjusts the system clock of the T4PX transmitter. Perform this setting when you purchase the set and when adjustment is necessary.

Whether the time or the total timer (accumulation timer) is displayed on the initial screen can be set. The total timer can be reset at this menu. When the total timer is displayed on the initial screen, it can also be reset at the initial screen.

This setting is displayed from the screen of the system menu. (p.144)

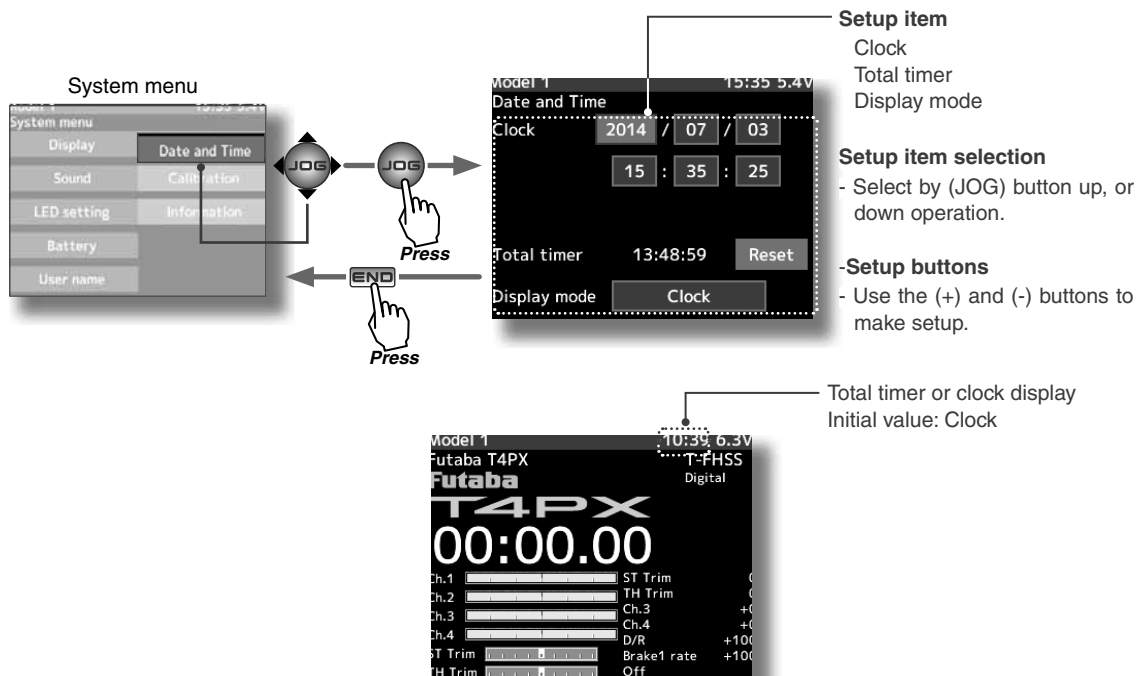

Date and time setting

Function

1 (Date and time setting)

Select the "Year", "Month", "Day", "Hour", "Minute" or "Second" to be set by (JOG) button operation, and use the (+) and (-) buttons.

Select "Time adjust" by (JOG) button up, down, left, or right operation, and press the (JOG) button. The system clock is updated.

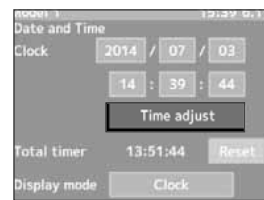

2 (Total timer reset)

Select the "Reset" to be set by (JOG) button operation, and press the (JOG) button. The total timer is reset.

3 (Select Display mode)

Select the "Display mode" to be set by (JOG) button operation, and use the (+) and (-) buttons to select the Display mode

4 When ending setting, return to the system menu screen by pressing the (END) button.

Information

System program version information, and selection of language.

This setting is displayed from the screen of the system menu. (p.144)

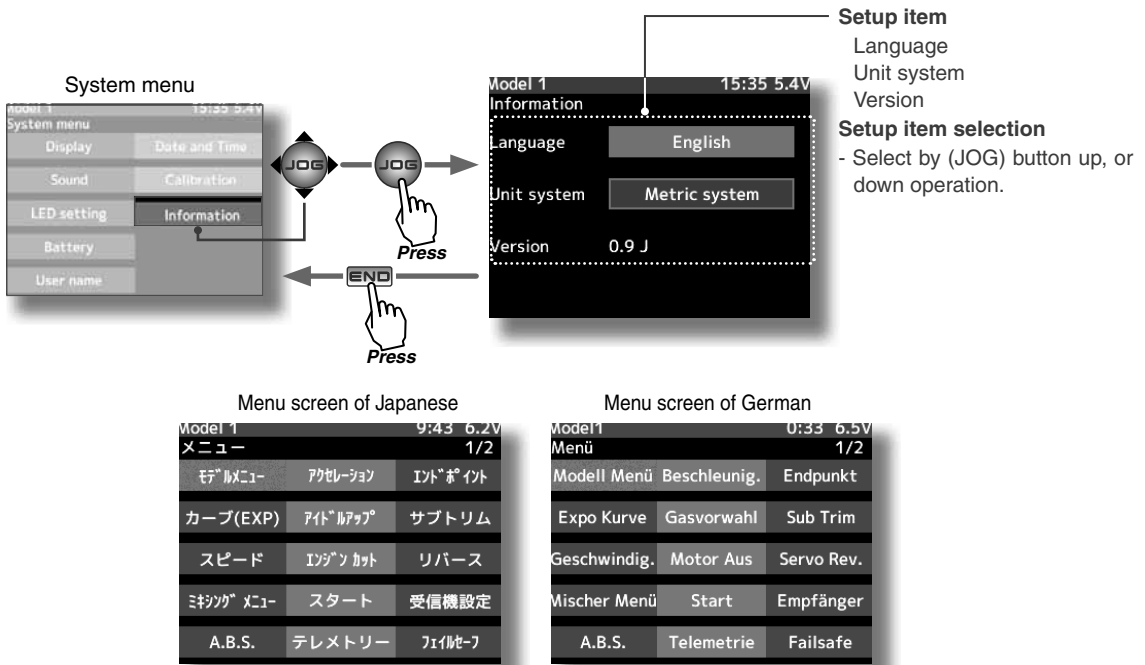

Information

1 (Language setting)

Select "Language" by (JOG) button up operation and press the (JOG) key. A list of languages appears on the screen. Select "English", "Japanese", or "German" by (JOG) button up or down operation and press the (JOG) button. The language changes.



2 (Units system setting)

Select "Units system" by (JOG) button up or down operation and select the metric system or yard and pound system by pressing the (+) or (-) button.

3 When ending setting, return to the system menu screen by pressing the (END) button.

Calibration

Steering and throttle correction can be applied. Use this function when a mechanical offset has occurred for some reason.

However, if correction was applied, it may be necessary to recheck the set values of all the setup functions.

This setting is displayed from the screen of the system menu. (p.144)

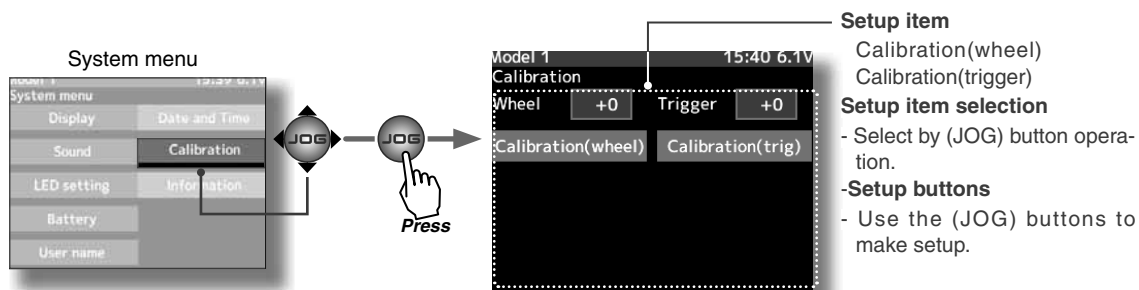

Steering adjustment

(Preparation)

Select "Wheel" (steering side) by (JOG) button left or right operation and press the (JOG) button. The neutral correction screen appears.

1 (Steering neutral adjustment)

After pulling the wheel was lightly to the left or right, press the (JOG) button in the state in which the wheel is not touched. If neutral correction is OK, the end point correction screen appears. If not within the correction range, the end point correction screen will not appear.

2 (Steering wheel travel adjustment)

In the end point correction screen (figure at the right) state, lightly turn the wheel fully to the left and right and press the (JOG) button. If end point correction is OK, the display returns to the adjuster screen. If the end point is not within the correction range, the display does not return to the adjuster screen. In this case, return to the system menu screen by pressing the (END) button. If operation cannot be ended normally even when correction is repeated, please contact the Futaba Service Center.

3 When ending setting, return to the system menu screen by pressing the (END) button.

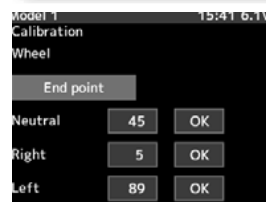
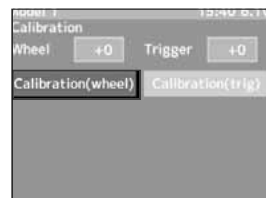

Throttle adjustment

(Preparation)

Select "Trigger" (throttle side) by (JOG) button left or right operation and press the (JOG) button. The neutral correction screen appears.

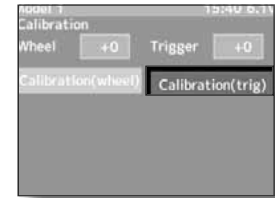

1 (Throttle neutral adjustment)

After lightly pulling the throttle trigger to the left and right, press the (JOG) button in the state in which the trigger is not touched. If neutral correction is OK, the end point correction screen appears. If not within the correction range, the end point correction screen will not appear.

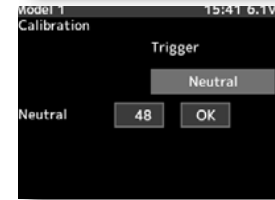

2 (Steering travel adjustment)

In the end point correction screen (figure at the right) state, lightly operate the trigger to the full forward and full brake side and press the (JOG) button. If end point correction is OK, the display returns to the adjuster screen. If not within the correction range, the display will not return to the adjuster screen. In this case, return to the system menu by pressing the (END) button. When operation cannot be ended normally even when correction is repeated, and cannot be ended normally, contact the Futaba Service Center.

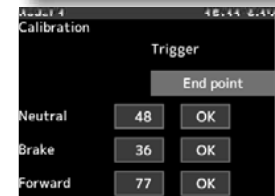
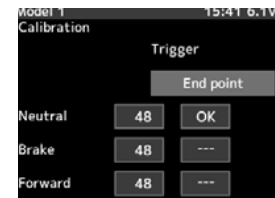

3 When ending setting, return to the system menu screen by pressing the (END) button.

Steering Dual Rate/ Throttle ATL "D/R ATL"

D/R (Steering dual rate)

The steering left and right servo travels are adjusted simultaneously. This setting is linked to transmitter grip dial DT5. When DT5 is assigned another function, dual rate can be adjusted with this screen.

ATL (Brake1 rate)

This function decreases the set value when the braking effect is strong and increases the set value when the braking effect is weak. This function is linked to transmitter grip dial DT6. When DT6 is assigned another function, this function can be set with this screen.

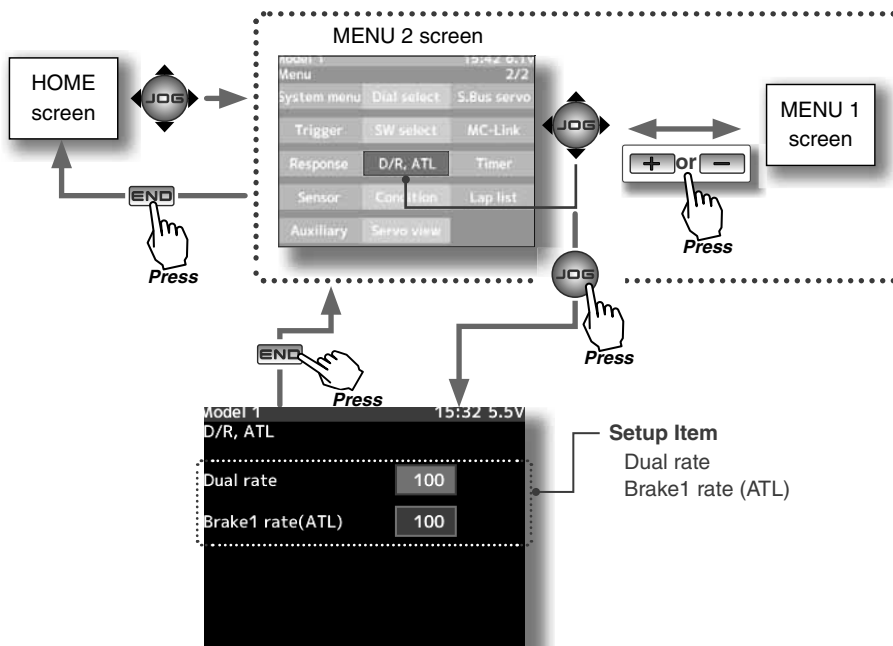

Dual rate adjustment

1 (Dual rate adjustment)

Select the setting item "Dual rate" or "Brake1 rate" by (JOG) button up or down operation. Adjust the servo travel with the (+) and (-) buttons.

This dual rate servo travel is linked to the grip trim.

2 When ending setting, return to the menu screen by pressing the (END) button.

Setup item selection

- Select by (JOG) button up or down operation.

Adjustment buttons

- Use the (+) and (-) buttons to make adjustments.
- Press the (+) and (-) buttons simultaneously (approx. 1 sec) to return to the initial screen.

D/R rate (RATE)

0~100%

Initial value: 100

Auxiliary Channel "CH3", "CH4"

The channel 3/4 servo position can be set from the transmitter. When CH3 is assigned to a dial by the dial function (p.101), this setting is linked to that dial.

When CH3/4 is not assigned to a dial, it can be set with this screen.

When CH3/4 is assigned to a switch by the switch function (p.99), you cannot adjust the CH3/4 via the screen.

When CH3 or CH4 is assigned by mixing function, channel operation cannot be performed at this screen.

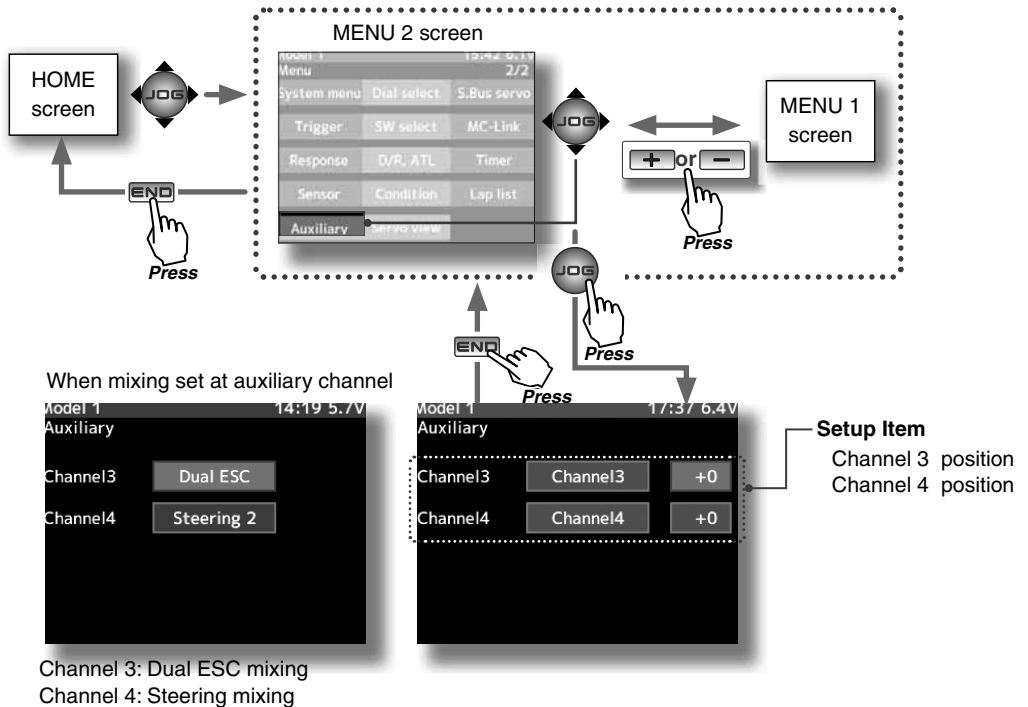

Channel 3/4 adjustment

1 (Position adjustment)

Use the (+) and (-) buttons to adjust the channel 3 or channel 4 position.

2 When ending setting, return to the initial screen by pressing the (END) button twice (for function menu screen, press the (END) button once).

Adjustment buttons

- Use the (+) and (-) buttons to make adjustments.
- Press the (+) and (-) buttons simultaneously (approx. 1 sec) to return to the initial screen

Channel 3 position (POSI)

Channel 4 position (POSI)

0~100%

Initial value: 100%

Servo View

Servo operation of each channel can be checked. Operation of the steering angle adjustment, when a mixing function was set, etc. can be easily checked.

The neutral position of the throttle channel varies depending on the modes defined by the "Trigger-Ratio". The screen shown below shows an example of "Forward50/Brake50" mode.

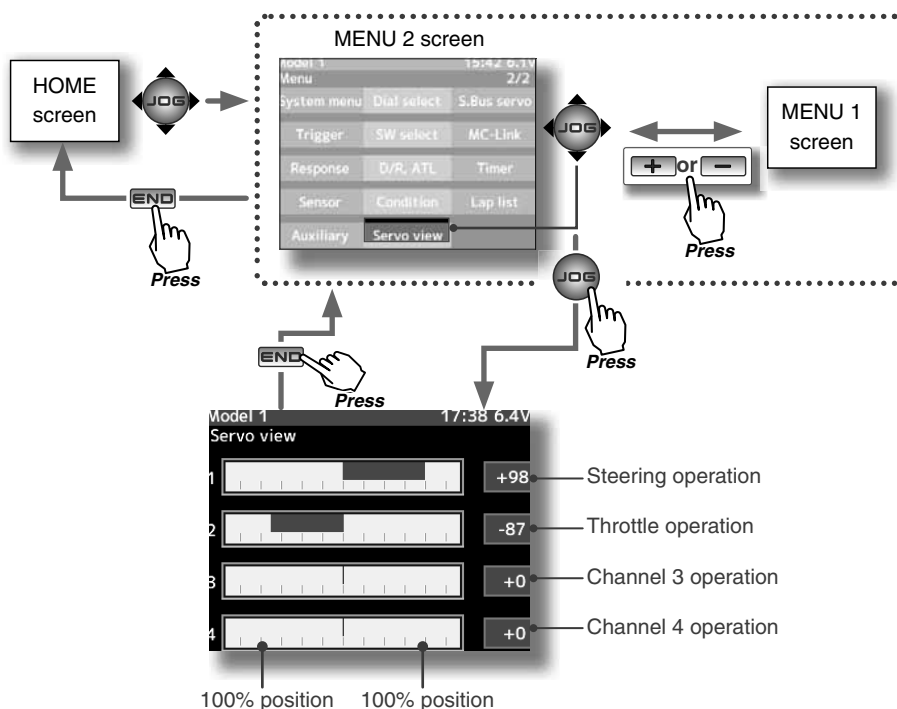

Function

Ending the "Servo view" screen

- 1 When ending servo operation checks, return to the menu screen by pressing the (END) button.
- 2 When ending setting, return to the menu screen by pressing the (END) button.

Specifications

*Specifications and ratings are subject to change without prior notice.

Transmitter T4PX

(Wheel system, 4 channels)

- Transmitting frequencies 2.4GHz band
- Futaba T-FHSS(R304SB/SB-E)/S-FHSS(R2104GF, R204GF-E/FASST-C2(R614FS/FF-E/FF, R604FS/FS-E)
- Power requirement
 - (Ni-MH battery) NT5F1700B Ni-MH battery (6V)
 - (LiFe battery) FT2F1700BV2 (6.6V)
- Current drain 300mA or less (When the T-FHSS, Vibration off, back lighting on)
- Transmitting antenna 1/2λdipole

Receiver R304SB / R304SB-E: (T-FHSS system, 4 channels)

Receiving frequency: 2.4GHz band

Power requirement: 4.8V~7.4V battery / 3.5 ~ 8.4V useable (Dry cell battery cannot be used.)

System: T-FHSS system (auto detection)

Size:

R304SB :1.38x0.91x0.33" (35.1x23.2x8.5mm) (excluding a projection part)

R304SB-E :1.38x0.91x0.49" (35.1x23.2x12.5mm)(excluding a projection part)

Weight: R304SB :0.23oz. (6.6g) / R304SB-E :0.24oz. (6.7g)

⚠ Caution

- ❶ When using the 4PX in the "Digital servo" type, always use it under the following conditions:

Servos :Futaba digital servo (including BLS Series brushless servos)

Receiver's battery :Matched to the ratings of the receiver and connected digital servo (dry cell battery cannot be used).

Transmitter mode :Digital servo type(See p.39 for setting method.)

Under other conditions, the set will not operate, or the specified performance will not be displayed even if it operates. In addition, it may cause servo trouble. Futaba will not be responsible for damage, etc. caused by combination with the products of other companies.

In addition, the FSU Fail Safe Unit cannot be used because the system is different. Use the fail safe function of the transmitter.

- ❷ When using analog servos, always switch the 4PX servo type to the "Analog servo" mode.

Transmitter mode :Analog servo type(See p.39 for setting method.)

Receiver's battery :Matched to the ratings of the receiver and connected servo.

The set cannot operate in the "Digital servo" type. Operation in this type will cause trouble with the servo and other equipment.

Digital servos (including BLS Series brushless servos) can also be used in the "Analog servo" type.

Optional Parts

The following parts are available as T4PX options. Purchase them to match your application. For other optional parts, refer to our catalog.

Transmitter Battery

When purchasing a transmitter battery use the following:

Part name

HT5F1800B (6V/1800mAh) Ni-MH battery

FT2F1700B(6.6V/1700mAh)/2100BV2 (6.6V/2100mAh) Li-Fe battery

Please do not use the transmitter batteries HT5F1800B and FT2F1700/2100BV2 as the receiver's battery.

T4PX Angle spacer

This Angle spacer is option part for T4PX. Angle of a steering wheel can be changed.

Refer to the page 28 of this manual for means of attachment.

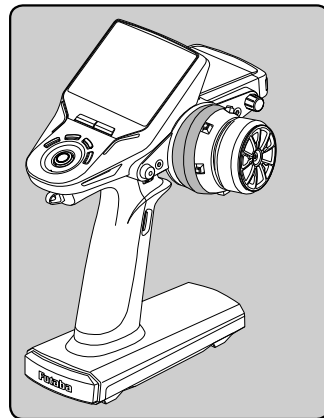
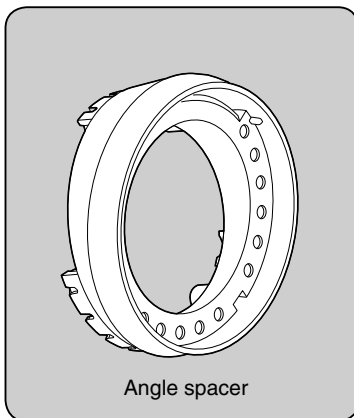

Large grip (for transmitter)

This handle grip is larger than the standard handle grip.

It is perfect for those with large hands.

Remove and replace the standard handle grip.

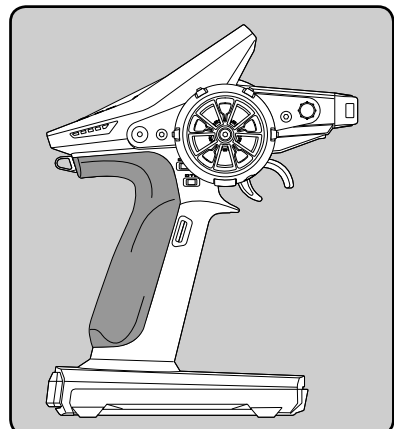

Carbon handle (for transmitter)

An optional carbon handle can be installed to the T4PX. Use the 2.0 hex wrench supplied with the 4PX set to install it. The flat head screws (3x10) are supplied with the optional carbon handle.

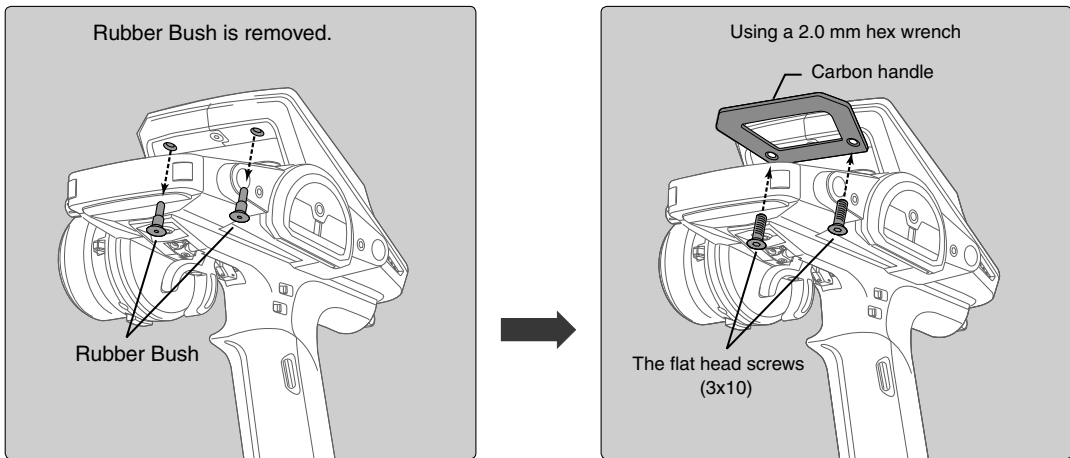

Telemetry sensors

Usable sensor options(As of June 2014)

Temperature sensor (SBS-01T) Perfect for engine head, etc.

Temperature sensor (SBS-01TE) Used by attaching to a motor, etc.

RPM Sensor (SBS-01RM) Measures speed over the 0 to 999,900rpm range.

Voltage Sensor (SBS-01V) Measures external power supply voltages up to 100V.

About data saved to microSD card

When a microSD card is installed in the T4PX transmitter, a folder called "Futaba" is created. Folders called "LOG" and "MODEL" are created in this folder. The "MODEL" folder stores the model data and the "LOG" folder stores the telemetry log data. When "Screen capture" is set at the push switch by switch setting, an image of the screen to be displayed on the T4PX is saved by that switch. The saved image is stored in a folder call "PICTURE". A "PICTURE" folder is not created until "Screen capture" is set.

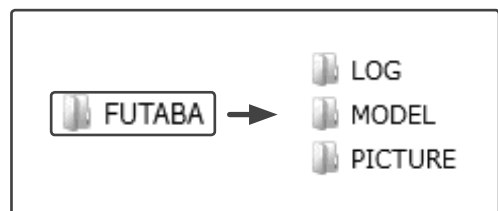

Warning Displays

Low Battery Alarm

If the transmitter battery voltage drops below the usable range, an audible alarm will sound and "Low battery" will be displayed. Since the usable range of LiFe and NiMH batteries and LiFe batteries is different, the power supply used must be set by system setting.(p.148)



Audible alarm: Continuous tone.

The vibrator: Active (initial setting) page 148

Warning

❗ When a low battery alarm is generated, cease operation immediately and retrieve the model.

If the battery goes dead while in operation, you will lose control.

Power off forgotten alarm

At T4PX initialization, if steering wheel, throttle trigger, push switch, edit button, or other operation is not performed within 10 minutes, an audible alarm will sound and the message "Warning: Auto power off" will appear. If steering wheel, throttle trigger, push switch, edit button or other operation is performed, the alarm is reset. Also turn off the power when the transmitter is not in use. If you do not want to use this alarm and the auto power off function, they can be disabled by system setting. (p.148)



Audible alarm:

Tone sounds (7 times) and stops (repeated)

- If the alarm is not reset, the auto power off function will automatically turn off the power after 5 minutes.

MIX Warning

When the power switch is turned on while the idle-up, engine cut or neutral brake function switch is on, an audible alarm will sound and "Warning" will be displayed on the LCD. When that function switch is turned off, the alarm will stop.

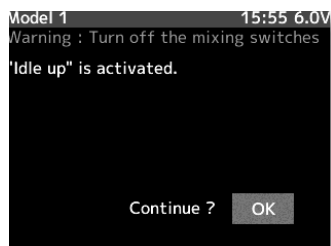

Audible alarm:

Tone sounds (7 times) and stops (repeated)

- The alarm stops even if the (JOG) button is pressed. However, check the function switch.

System Error

If the data is lost for an unknown reason, an audible alarm will sound and "System error" will be displayed on the LCD screen.



Audible alarm: Continuous tone.
The vibrator: Active (initial setting) page 148

Warning

- ❗ When a system error is generated, immediately stop using the system and request repair from the Futaba Service Center. If you continue to use the system, the transmitter may malfunction and cause loss of control.

Backup Error

If the data in the transmitter is not transferred normally when the power is turned on, an audible alarm will sound and "Backup error" will be displayed on the LCD.

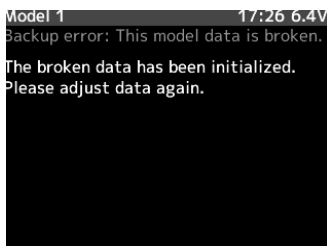

Audible alarm:
Tone sounds (7 times) and stops (repeated)

- To stop the alarm, turn off the power.
- Turn the power back on. If the alarm is not generated again, there is no problem.

RF Error

When the RF module does not operate, "RF Error" is displayed on the LCD.

If the power is turned on during charging, an RF error will be displayed and an audible alarm will sound. Immediately turn off the power.

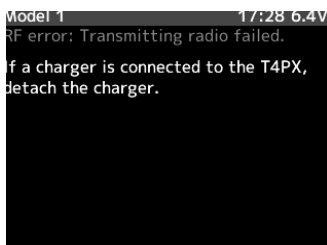

Audible alarm:
Tone sounds (7 times) and stops (repeated)

- To stop the alarm, turn off the power.
- Turn the power back on. If the alarm is generated again, request repair from the Futaba Service Center.

When requesting repair

Before requesting repair, read this instruction again and recheck your system. Should the problems continue, request as follows.

(Information needed for repair)

Describe the problem in as much detail as possible and send the letter along with the system in question.

- Symptom (Including the conditions and when the problem occurred)
- R/C System (Send transmitter, receiver and servos)
- Model (Type of model, brand name and model number or kit name)
- Detailed packing list (Make a list of all items sent in for repair)
- Your name, address and telephone number.

(Warranty)

Read the Warranty card.

- When requesting warranty service, send the card or some type of dated proof purchase.

When requesting repair

Before requesting repair, read this instruction again and recheck your system. Should the problems continue, request as follows.

(Information needed for repair)

Describe the problem in as much detail as possible and send the letter along with the system in question.

- Symptom (Including the conditions and when the problem occurred)
- R/C System (Send transmitter, receiver and servos)
- Model (Type of model, brand name and model number or kit name)
- Detailed packing list (Make a list of all items sent in for repair)
- Your name, address and telephone number.

(Warranty)

Read the Warranty card.

- When requesting warranty service, send the card or some type of dated proof purchase.

Federal Communications Commission Interference Statement (for U.S.A.)

This equipment has been tested and found to comply with the limits for a Class B digital device, pursuant to Part 15 of the FCC Rules. These limits are designed to provide reasonable protection against harmful interference in a residential installation.

This equipment generates, uses and can radiate radio frequency energy and, if not installed and used in accordance with the instructions, may cause harmful interference to radio communications. However, there is no guarantee that interference will not occur in a particular installation. If this equipment does cause harmful interference to radio or television reception, which can be determined by turning the equipment off and on, the user is encouraged to try to correct the interference by one or more of the following measures:

- Reorient or relocate the receiving antenna.
- Increase the separation between the equipment and receiver.
- Connect the equipment into an outlet on a circuit different from that to which the receiver is connected.
- Consult the dealer or an experienced radio/TV technician for help.

Compliance Information Statement (for U.S.A.)

This device, trade name Futaba Corporation, model number R304SB (SB-E), complies with part 15 of the FCC Rules. Operation is subject to the following two conditions:

(1) This device may not cause harmful interference, and (2) This device must accept any interference received, including interference that may cause undesired operation.

(3) This module meets the requirements for a mobile device that may be used at separation distances of more than 20cm from human body. To meet the RF exposure requirements of the FCC this device shall not be co-located with another transmitting device.

The responsible party for the compliance of this device is:

Futaba Service Center

3002 N Apollo Drive Suite 1, Champaign, IL 61822 U.S.A

TEL (217)398-8970 or E-mail: support@futaba-rc.com (Support)

TEL (217)398-0007 or E-mail: futabaservice@hobbico.com (Service)

CAUTION:

To assure continued FCC compliance:

Any changes or modifications not expressly approved by the grantee of this device could void the user's authority to operate the equipment.

Exposure to Radio Frequency Radiation

To comply with FCC RF exposure compliance requirements, a separation distance of at least 20 cm must be maintained between the antenna of this device and all persons. This device must not be located or operating in conjunction with any other antenna or transmitter.

©Copyright 2010. No part of this manual may be reproduced in any form without prior permission. The contents of this manual are subject to change without prior notice. While this manual has been carefully written, there may be inadvertent errors or omissions. Please contact our service center if you feel that any corrections or clarifications should be made.

FUTABA CORPORATION Phone: +81 475 32 6982, Facsimile: +81 475 32 6983
1080 Yabutsuka, Chosei-mura, Chosei-gun, Chiba 299-4395, Japan

4PX

4PX Telemetry System

Futaba®