

# **GYA 553**

## **6-Axis Flight Control**

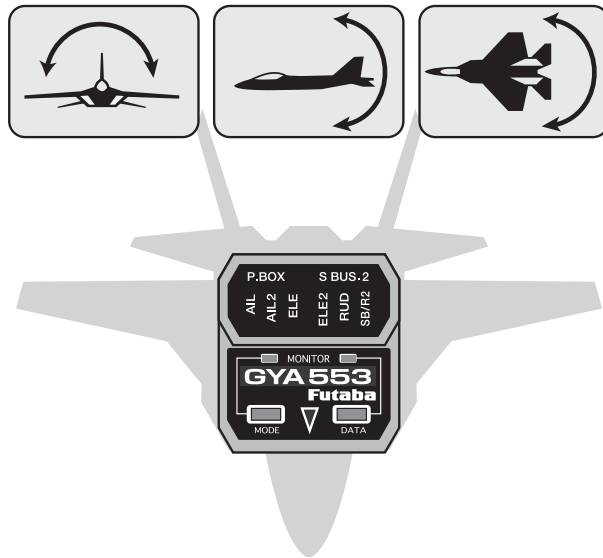

## **Software Update Functions**

## GYA553 Software Updating Procedure

### ***GYRO UPDATE (Update mode of GYA553)***

This menu is used to adjust the update mode of the GYA553. The mode selected will be determined by the model of the CIU selected and personal preference. For example, when using the CIU-3, the user may select either the high speed or the slow speed modes. If using the CIU-2, only the slow speed mode is available.

- \* The following optional products are required for the update.
- CIU-2 or CIU-3
- DSC cable for update
- Receiver battery

#### **(1) Download GYA553 update file**

Download the GYA553 update file from our website or your local distributor's website.

### **Connection diagram**

To the open/available slot of GYA553

A PC that can connect to the Internet and has CIU-2 or CIU-3 driver software installed.

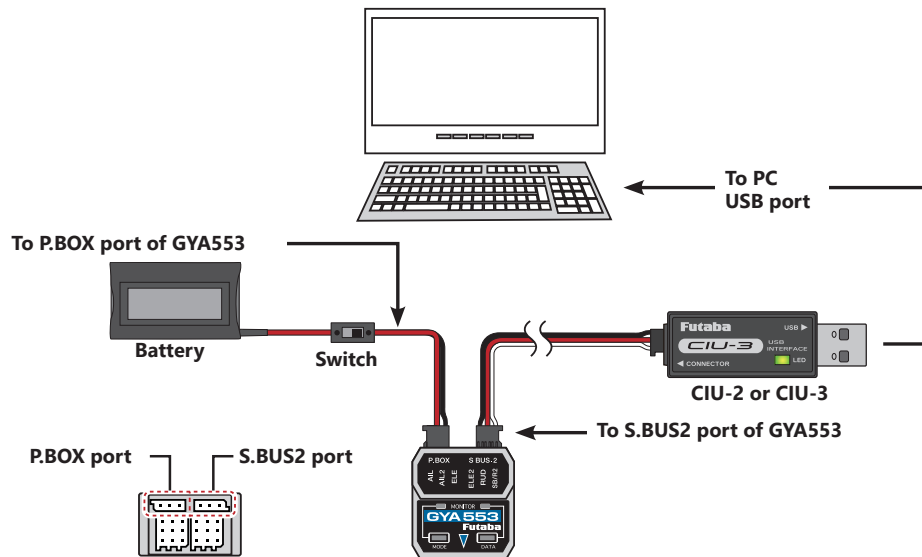

#### **(2) Preparation for update -1**

Connect the GYA553, GPB-1, CIU-2 or CIU-3 to the PC with reference to the above connection diagram.

## PC side

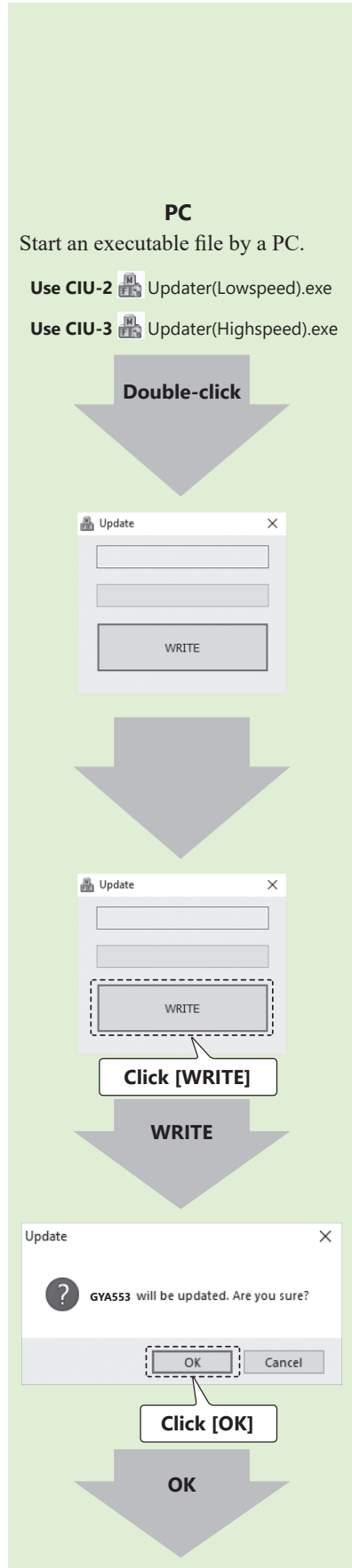

## GYA553 side

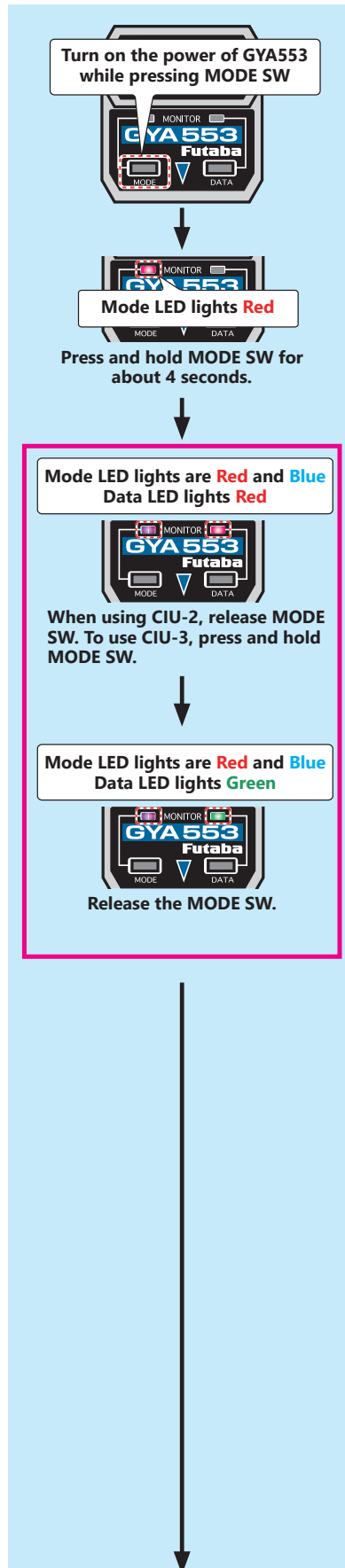

### (3) Selection of CIU (Speed)

Before turning on the power of **GYA553**, select the writing speed suitable for **CIU-2** or **CIU-3** to be used for updating.

#### [Selection method]

#### CIU-2

Turn on the power while pressing the **MODE SW** of **GYA553**. The **Mode LED** lights **Red** at first, then about 4 seconds later, **Red** and **Blue** light at the same time, and when the **Data LED** turns **Red**, release the **MODE SW**.

#### CIU-3

Turn on the power while pressing the **MODE SW** of **GYA553**. The **Mode LED** lights **Red** at first, then **Red** and **Blue** light up at the same time after about 4 seconds; press and hold **MODE SW** for another 4 seconds when the **Data LED** turns **Red**, and release **MODE SW** when the **Data LED** turns **Green**.

#### [LED display after setting]

CIU	Mode LED	Data LED
CIU-2 Low speed	Red and Blue light	Lights Red
CIU-3 High speed		Lights Green

### (4) Perform update

Click on the update file downloaded to the PC to update the GYA553.

#### ⚠ CAUTION

⊘ Do not turn off the power or remove the battery while updating. GYA553 may be damaged.

## PC side

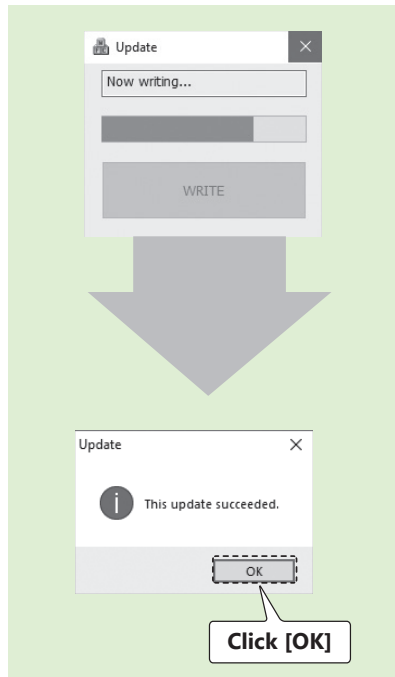

## GYA553 side

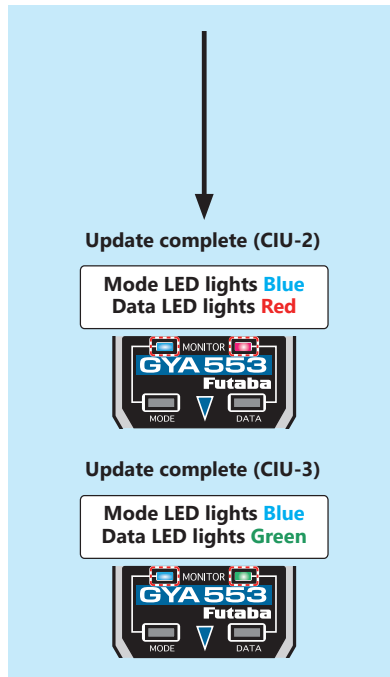

### (5) Update complete

When the update is completed successfully, Mode LED will turn blue.

### [LED display when update is completed]

CIU	Mode LED	Data LED
CIU-2 Low speed	Lights Blue	Lights Red
CIU-3 High speed		Lights Green

### Error

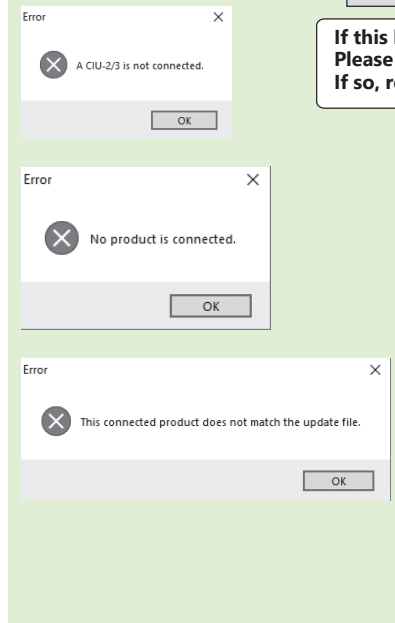

If this happens, it will be up from the beginning. Please try the update again. A place to fail again. If so, re-download the update file please.

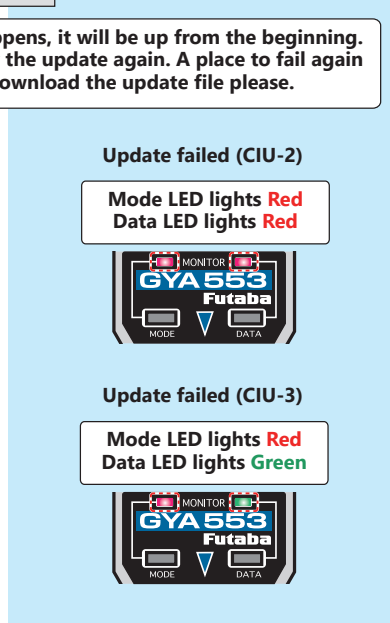

### [LED display when update fails]

CIU	Mode LED	Data LED
CIU-2 Low speed	Lights Red	Lights Red
CIU-3 High speed		Lights Green

If the cable disconnects or a contact failure occurs during the update, the update stops halfway. In that case, please try updating again from the beginning.

\* Ver 3.x settings require the following models. For the setting method, refer to the T32MZ GYA553 setting manual, T16IZ SUPER GYA553 setting manual, T16IZ GYA553 setting manual, and GPB-1 GYA553 setting manual on the software download page.

- T32MZ ▶ Ver 3.7 or later
- T16IZ ▶ Ver 3.4 or later      • T16IZ SUPER ▶ Ver 1.2 or later
- GPB-1 ▶ Ver 4.2 or later

### 1. SB/R2 port output selection

In order to support some servos and DLPH-1 that were not supported by the S.BUS output up to the previous version, S.BUS-STD was added to the S.BUS output selection in addition to S.BUS-HS (Same as previous S.BUS).

#### Parameter Settings

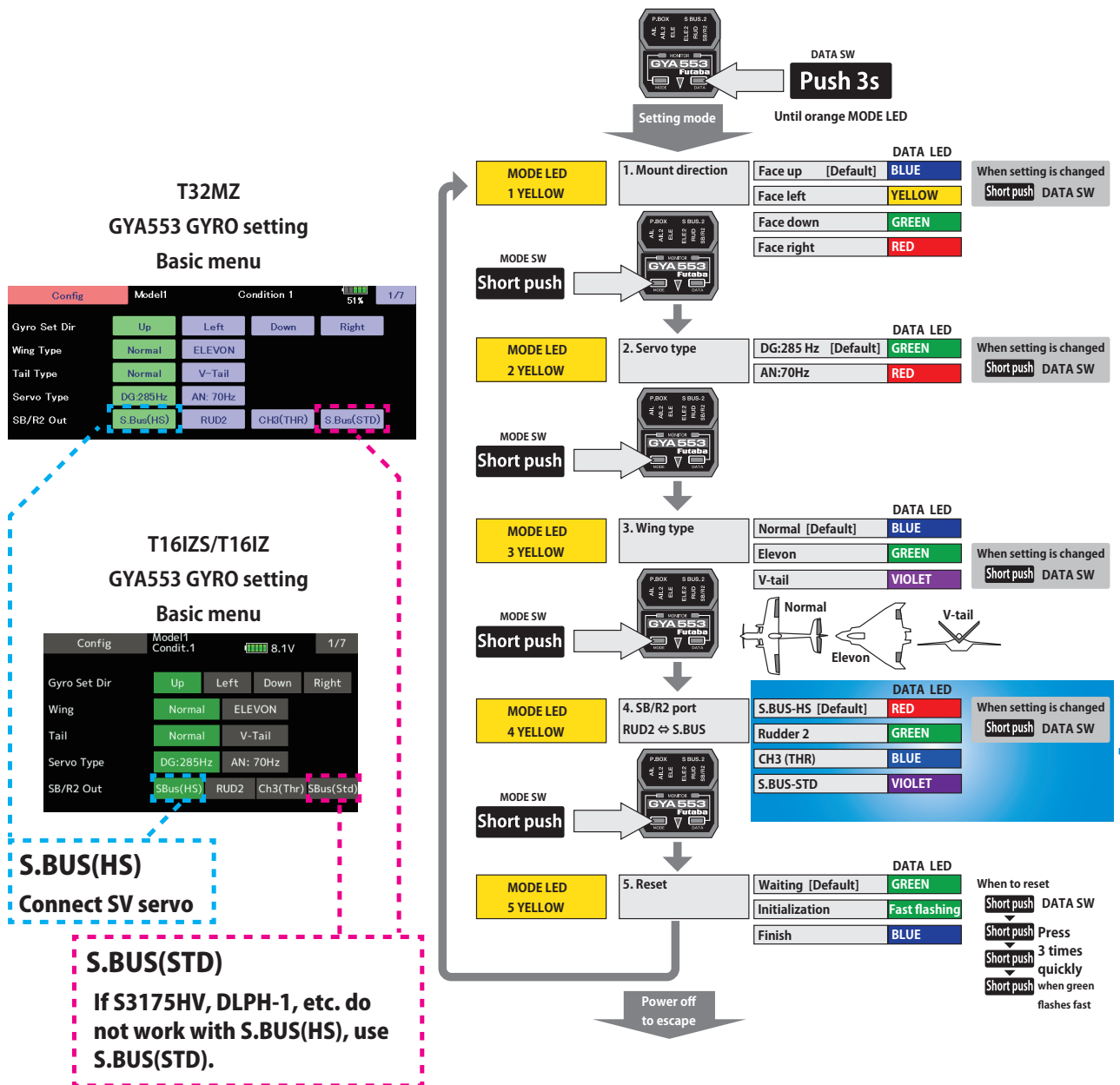

## 2. Added gyro control function for 3rd aileron (AIL3) and 4th aileron (AIL4)

When "S.BUS(HS)" or "S.BUS(STD)" is selected for the SB/R2 port output setting, gyro-controlled signals are output to 3rd AIL (AIL3) and 4th (AIL4).

- "S.BUS(HS)" or "S.BUS(STD)" is selected for the SB/R2 port output. ⇒ S.BUS basic setting screen, AIL3 and AIL4 items are displayed in the setting menu.

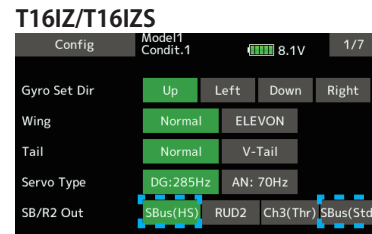
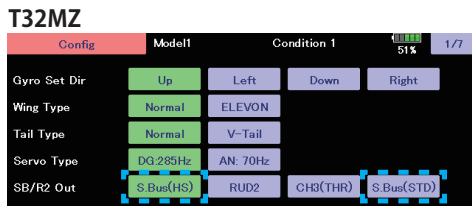

- CH setting items for AIL3 and AIL4 are displayed on the final screen of the S.BUS basic setting screen. By setting the operation CH of AIL3 and AIL4, the gyro-controlled signal is output to the corresponding CH of the S.BUS output.

\* Match the operation CH and CH setting on the function setting screen on the transmitter side.

\*When the AIL3 and AIL4 CH settings are INH, the gyro control is not performed and the data sent from the transmitter is output as is.

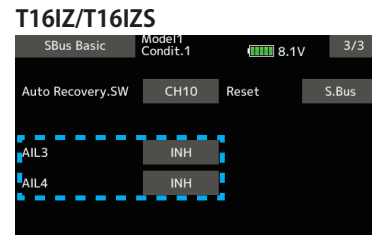
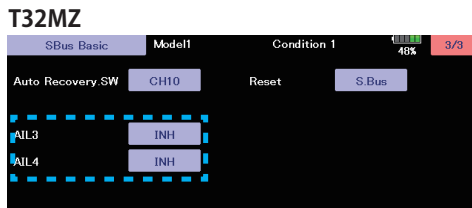

\* The S.BUS CH setting cannot be set by the button setting on the GYA553 main unit.

- If the SB/R2 port output is set to "S.BUS(HS)" or "S.BUS(STD)", the setting menu will display AIL3 and AIL4 setting items.

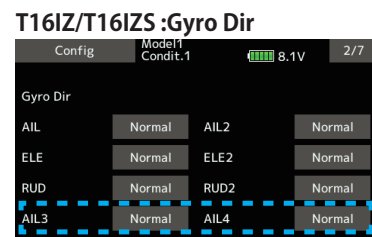
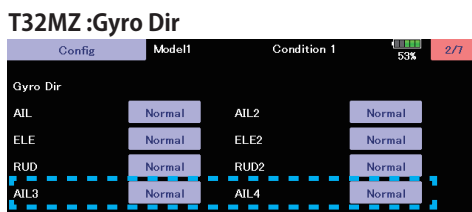

\* AIL3 and AIL4 settings cannot be set with the button settings on the GYA553 main unit.

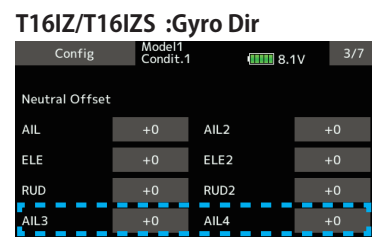
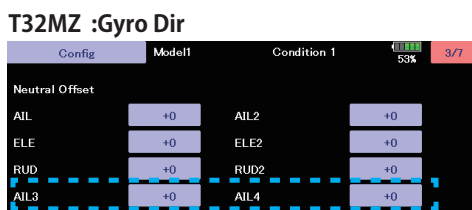

\* AIL3 and AIL4 settings cannot be set with the button settings on the GYA553 main unit.

## T32MZ :Servo Limit

Config Model1 Condition 1 53% 4/7

Srv.Limit

AIL	100 %	100 %
ELE	100 %	100 %
RUD	100 %	100 %
AIL3	100 %	100 %

Config Model1 Condition 1 49% 5/7

Srv.Limit

AIL2	100 %	100 %
ELE2	100 %	100 %
RUD2	100 %	100 %
AIL4	100 %	100 %

## T16IZ/T16IZS :Servo Limit

Config Model1 Condit.1 8.1V 4/7

Srv.Limit

AIL	100 %	100 %
ELE	100 %	100 %
RUD	100 %	100 %
AIL3	100 %	100 %

Config Model1 Condit.1 8.1V 5/7

Srv.Limit

AIL2	100 %	100 %
ELE2	100 %	100 %
RUD2	100 %	100 %
AIL4	100 %	100 %

\* AIL3 and AIL4 settings cannot be set with the button settings on the GYA553 main unit.

## Functions Ver 2.x

- (1) The Air-Brake function can be used in NORMAL mode.
  - (2) CH3 (THR) can be output to the RUD2 / S.BUS2 port.
  - (3) The "Holding power" of AVCS mode has been expanded to 5 types, and it is possible to switch with CH data.
- \* The following models are required for the settings of (2) and (3). For the setting method, for the setting method, refer to the T32MZ GYA553 setting manual, T16IZ GYA553 setting manual and GPB-1 GYA553 setting manual on the software download page.
- T32MZ ▶ Ver 3.6 or later
  - T16IZ ▶ Ver 3.3 or later
  - GPB-1 ▶ Ver 4.1 or later