

Please refer to the instruction manual of T4PM for the update method.

Compatible with BLS-CM600 / S-C400 / S-C300

V5.40

Added support to change the SR mode of BLS-CM600/S-C400/S-C300.

* UR mode is not supported. If the servo is set to UR mode, change it to normal mode or SR mode before using it.

Compatible with HPS-CT501

V5.30

Added support to change the SR mode of HPS-CT501.

* UR mode is not supported. If the servo is set to UR mode, change it to normal mode or SR mode before using it.

Compatible with HPS-CT702/HPS-CD700

V5.20

Added support to change the SR mode of HPS-CT702 and HPS-CD700.

* UR mode is not supported. If the servo is set to UR mode, change it to normal mode or SR mode before using it.

Compatible with HPS-CB701

V5.10

Added support to change SR mode of HPS-CB701.

* UR mode is not supported. If the servo is set to UR mode, change it to normal mode or SR mode before using it.

Compatible with HPS-CT701

V5.04

Added support to change SR mode of HPS-CT701.

* UR mode is not supported. If the servo is set to UR mode, change it to normal mode or SR mode before using it.

Radio communication

V5.03

Improvements have been made to enable more stable communication even in an environment where many transmitters are emitting radio waves in the same area.

Gyro Link

Changed the setting range of the Gyro Link limit value from 10 to 130.

Software fix

V5.01

Fixed the timer function.

Update function / Roll Out Chart and Gear Ratio Chart

V5.0

The selection range of each setting has been expanded to support the Kyosho Mini-Z.

Setting range after update

Pinion gear: 5-75 / Spar gear: 25-130 / Tire diameter 20.0-65.0

Other

Added support to change SR mode of HPS-CB500 / HPS-CT500.

The Gyro Link is a function that allows you to set the parameters of the car gyro wirelessly from the transmitter.

* A gyro compatible with the wireless setting: GYD550 (As of April 2020)

- Up to five presets can be switched while driving. (Gyro data switching function)
- The S.BUS servo data can be set wirelessly from the transmitter via the gyro.

* A receiver compatible with the wireless setting function is required. (As of April 2020, R334SBS / R334SBS-E is compatible with wireless setting. Please update the previous receiver to version 4.0 or later.)

* While using Gyro Link wireless (SBUS connection) SBUS servo adjustment will not function.

- To be able to control gyro gain, etc. from the transmitter, it is necessary to enable the gyro mixing function of the transmitter.

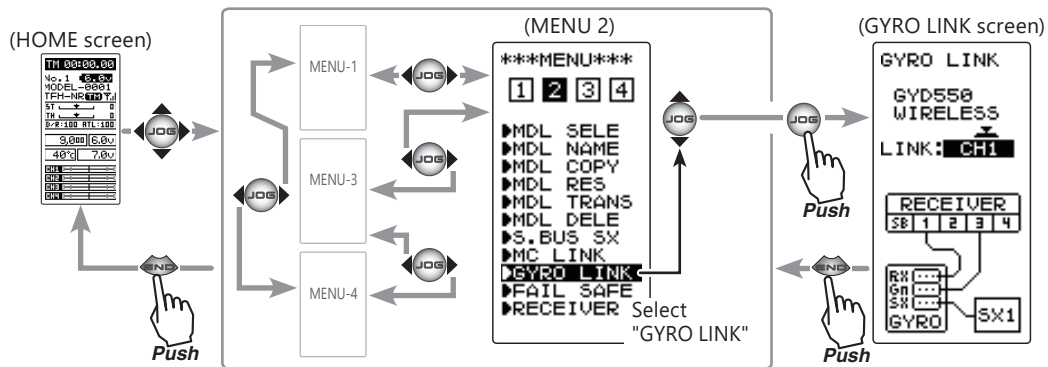

Using the Gyro Link function

(Preparation)

- Connect the receiver and gyro according to the connection diagram below.

* The connection diagram is a reference diagram for selecting the gyro link connection method. Please read the gyro instructions for details or cautions.

1 Turn on the power switch of the transmitter to display the Gyro Link screen. Turn on the receiver power switch.

2 (Gyro read)

Execute this function to read the data currently set at the gyro. Select the setting item "LINK" by moving the (JOG) button up or down. Select the connection type by (+) or (-) button, and press the (JOG) button. A beep sounds and the gyro data is read.

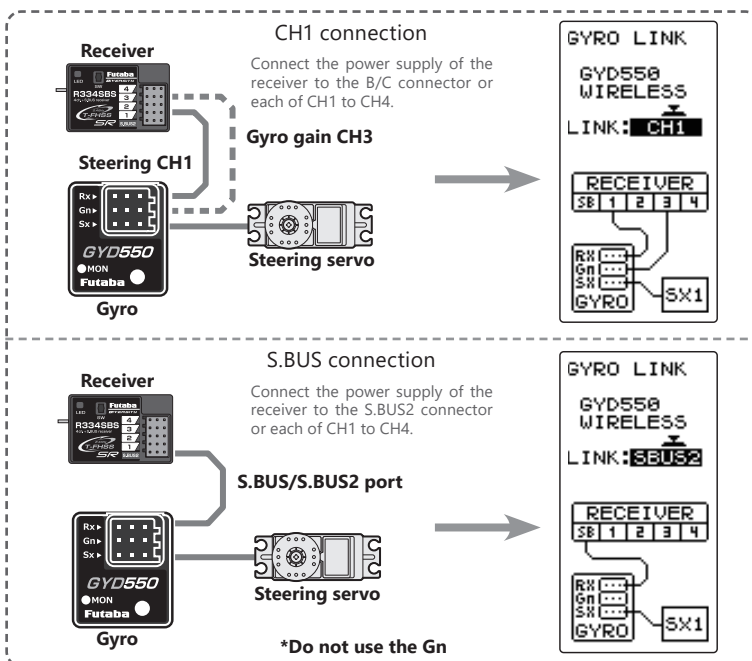

- If "COM-ERROR" blinks on the screen, communication with the gyro is not being performed normally. Check the connection between the receiver, gyro, and battery, turn on the power of the transmitter and receiver, and repeat READ.

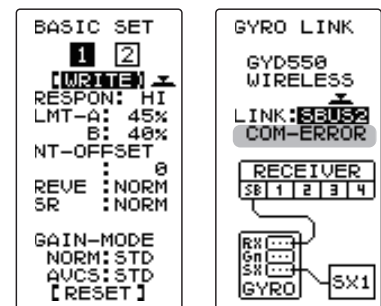

3 (Writing to gyro)

Execute this function to write the setting data to the gyro.

Select the setting item "WRITE" by moving the (JOG) button up or down, and press the (JOG) button. A beep sounds and the gyro data is written.

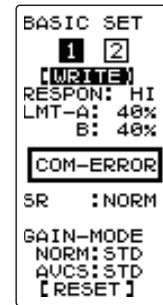
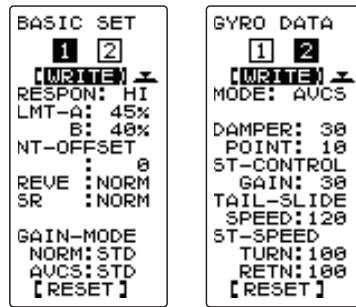

- If "COM-ERROR" blinks on the screen, communication with the gyro is not being performed normally. Check the connection between the receiver, gyro, and battery, turn on the power of the transmitter and receiver, and repeat WRITE.

4 (Initialization)

This function writes the gyro setting data set at the factory to the connected gyro.

Select the setting item "RESET" by moving the (JOG) button up or down, and press the (JOG) button. A beep sounds and the gyro data is initialization.

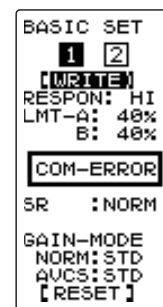
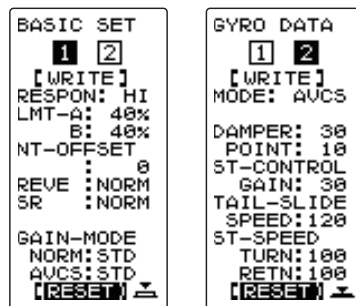

- If "COM-ERROR" blinks on the screen, communication with the gyro is not being performed normally. Check the connection between the receiver, gyro, and battery, turn on the power of the transmitter and receiver, and repeat RE-SET.

Data settings

Select the setting item by moving the (JOG) button up or down. Set the value by (+) and (-) button.

Example: (BASIC SET screen)

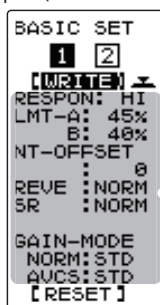

Setup item selection
Select by the (JOG) button.
The item indicated by the reverse displayed cursor is selected.

Set button

- Use the (+) and (-) buttons to make adjustments.
- Return to the initial value by pressing the (+) and (-) buttons simultaneously (approx. 1 sec).

(BASIC SET screen)

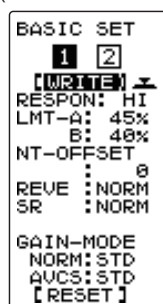

(GYRO DATA screen)

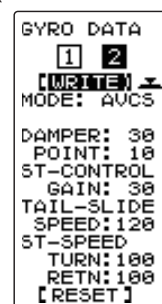

BASIC SET

- * In the T-FHSS SR mode, the servo position will not adjust until "WRITE", even if the "LMT" and "NT-OFFSET" functions are adjusted with (+) and (-) buttons.

RESPON (Response mode)

Gyro sensor response setting.

- * LOW → MID → HI speeds up response.
- * In high mode, using the dead band angle is too small, the servo will work continuously, but there is no problem in running. However, if strong the servo will work continuously occurs, set to middle or low mode.

LMT A/B (Limit A/B)

Adjustment function of maximum steering angle.

- * Operate the steering and adjust the left and right separately so that the maximum steering angle is obtained as long as the tires do not interfere with the arms.
- * If the adjustment value of the limit is small (the maximum steering angle is not adjusted), it becomes easier to spin.
- * During limit adjustment, the steering angle is amplified by 1.5 times, but this is not a malfunction. However, perform drive after completing the limit adjustment.

SR (SR mode setting)

Set to SR mode.

- * Set the SR compatible servo to SR only when using SR mode.

```

BASIC SET
 1 2
[WRITE]
RESPON: HI
LMT-A: 45%
      B: 40%
NT-OFFSET
      : 0
REVE : NORM
SR   : NORM

GAIN-MODE
NORM: STD
AVCS: STD
[RESET]
    
```

Basic setting screen

NT-OFFSET (Neutral offset)

Neutral adjustment function of the steering servo.

- * Do not use transmitter trim and sub trim. Make the neutral setting with a gyro.

REV (Reverse)

Gyro control direction setting.

- * If the car is turned to the left by hand steering goes out on the right.



GAIN-MODE (Gain mode)

Gyro internal control gain switching.

- * High gain is 1.5 times more sensitive than standard gain.
- * Normally set to standard.
- Set to high gain if increasing the sensitivity setting of the transmitter to the maximum value is not enough.

GYRO DATA

The data can be set independently in each gyro operation mode (AVCS / NORMAL).

AVCS and normal mode change button

The AVCS / NORMAL modes setting.

The gyro has 2 operating modes: NORMAL mode and AVCS mode. In the AVCS mode, gyro control is firmer.

- * The feel of operation is different, choose your favorite mode.
- * NORMAL: The driver needs to perform counter-steer → Operation opposite to the turn direction.
- * AVCS: The gyro performs countersteer → Steer in the turn direction.

DAMPER (Damper)

Hunting suppression

The higher the value, the stronger the hunting suppression. However, it will feel like the servo response has worsened.

ST-CONTROL GAIN (Steering control gain)

Adjustment of intervention ratio of steering operation to gyro control.

When the numerical value is increased, the steering operation of the driver is largely reflected.

- * The steering response feels fast.

ST-SPEED (Steering speed)

The function to adjust servo speed for steering operation (same the function as servo speed of the transmitter).

- * The smaller the value, the slower the servo speed.

```

GYRO DATA
 1 2
[WRITE]
MODE: AVCS

DAMPER: 30
POINT: 10
ST-CONTROL
GAIN: 30
TAIL-SLIDE
SPEED: 120
ST-SPEED
TURN: 100
RETN: 100
[RESET]
    
```

Gyro data screen

DAMPER POINT (Damper point)

Adjust the servo response due to the effect of the damper against the gyro effect.

- * The smaller the value, the stronger the influence of the Damper and the slower the servo speed.
- * The higher the value, the slower the Damper will operate and the better the response, but the more likely it is that hunting will occur.

TAIL- SLIDE SPEED (Tail slide speed)

Adjust the speed of the tail slide (shake the tail) when driving.

- * Decreasing the numerical value decreases the speed of the tail slide, and increasing the numerical value increases the speed.
- * Effective for adjusting the tail slide amount during steering operation.

Additional / Acuvance Xarvis / XarvisXX compatible (MC (ESC) Link)

The MC (ESC) Link function is now compatible with Acuvance ESC Xarvis and XarvisXX.

* Please contact Acuvance for details of Xarvis / XarvisXX functions.

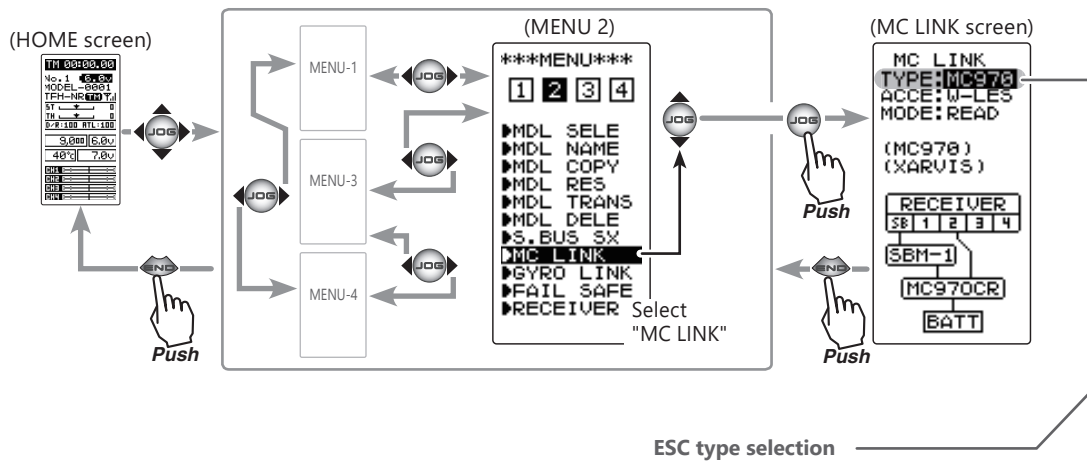

- When using the MC970CR or Acuvance Xarvis, select "MC970CR", and when using Acuvance XarvisXX, select "XarvisXX".
- For Futaba ESC MC960CR, MC950CR, MC851C, MC602C, MC402CR, etc., please choose Other.

* MC970CR is available only in the Japanese market. (As of April 2020)

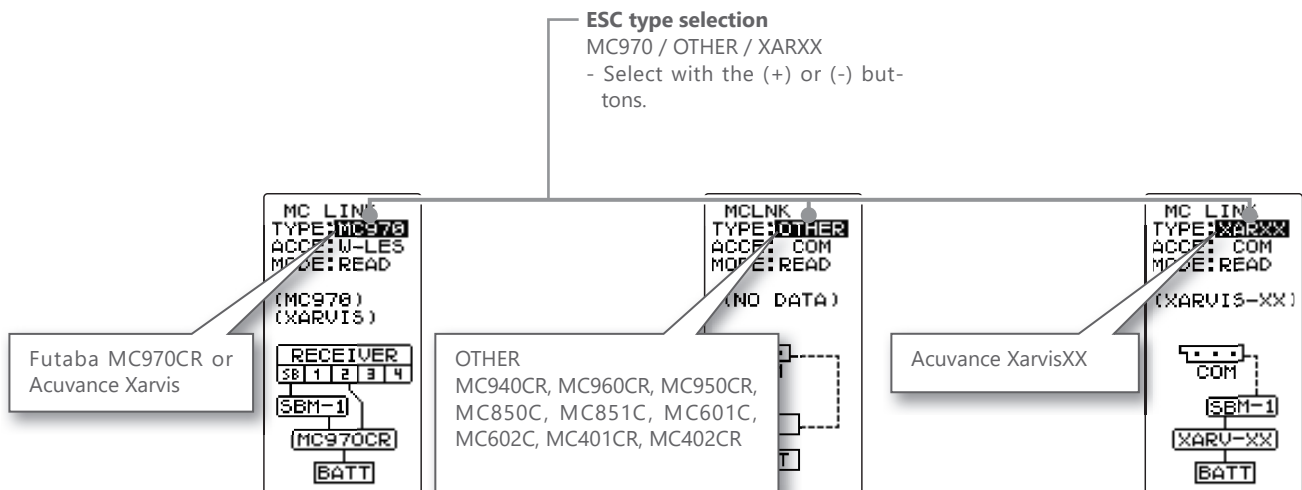

If the track is slippery and you begin to accelerate by pushing the trigger to full throttle, the car wheels will spin and the car will not accelerate smoothly. When the Start function is activated, merely operating the throttle trigger slowly causes the throttle servo to automatically switch from the set throttle position to a preset point so that the tires do not lose their grip and the car accelerates smoothly.

Without "Start" function

Wheels spin- Car does not accelerate



With "Start" function

Tires grip the track firmly- Car accelerates



Operation

- When the throttle trigger is moved to the preset position (TRIGGER POINT), the throttle servo moves to the preset position.
- When the throttle trigger is operated slowly so that the wheels will not spin, the car automatically accelerates to the set speed.
- This function is effective only for the first throttle trigger operation at starting. This function has to be activated before every start.
- When the throttle trigger is returned slightly, the Start function is automatically deactivated and the set returns to normal throttle trigger operation.

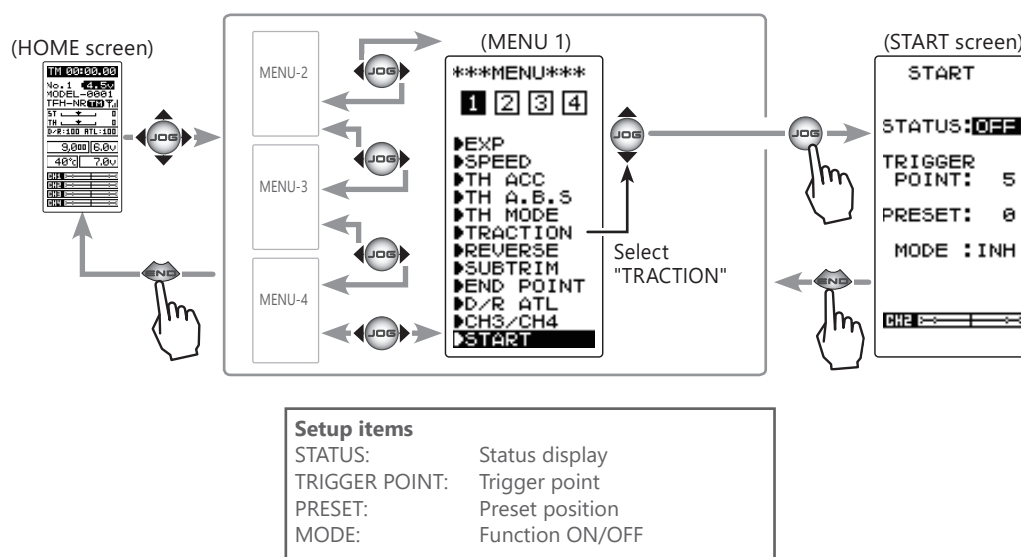

Traction control function adjustment

1 (Function ON/OFF)

Select the setting item "MODE" by moving the (JOG) button up or down. Use the (+) or (-) button and set the function to the "ON" or "OFF" state.

"INH": Function OFF.
 "ACT": Function ON.

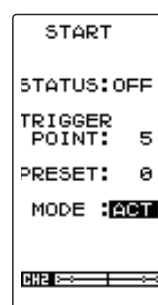

Function ON/OFF (MODE)

INH,ACT

Select button

- Select with the (+) or (-) buttons.

2 ("Trigger point" setup)

Select the setting item "TRIGGER POINT" by moving the (JOG) button up or down. Use the (+) and (-) buttons to adjust the delay amount.

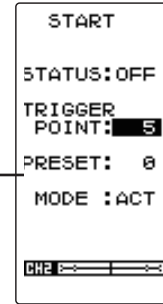

Trigger point (TRIGGER POINT)

5 ~ 95
Initial value: 5

Set button

- Use the (+) and (-) buttons to make adjustments.
- Return to the initial value by pressing the (+) and (-) buttons simultaneously (approx. 1 sec).

3 ("Preset position" setup)

Select the setting item "PRESET" by moving the (JOG) button up or down. Use the (+) and (-) buttons to adjust the return amount.

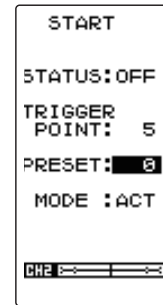

Preset position (PRESET)

0 ~ 100
Initial value: 0

Adjustment buttons

- Use the (+) and (-) buttons to make adjustments.
- Return to the initial value by pressing the (+) and (-) buttons simultaneously (approx. 1 sec).

4 ("Ready" setup)

Select the setting item "STATUS" by moving the (JOG) button up or down, and press the (JOG) button simultaneously for about 1 second, the display will change to [RDY] and wait for trigger operation.

In the [RDY] state, if the throttle trigger is operated to the position of the "TRIGGER POINT", the throttle servo moves to the servo operation position set with preset. It is canceled when the throttle trigger is returned.

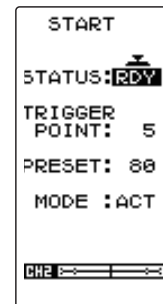

Status display (STATUS)

- OFF: Start function OFF
- RDY: Wait for trigger operation
- ON: Start function ON

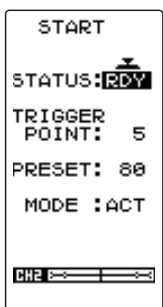

Operate (or pass) the throttle trigger from the status display "RDY" to the trigger position.

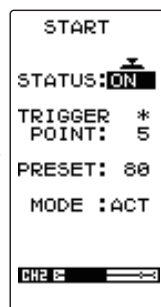

The throttle servo moves to the "PRESET" position and the status display is "ON".

Return the throttle trigger a slightly.

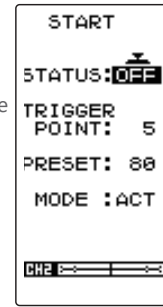

The Start function is automatically deactivated and the set returns to normal throttle trigger operation. The status display is "OFF".

5 When finished with the setting, return to the MENU screen by pressing the (END) button.

Changed function / Model copy

- The new model copy function allows you to copy the model data of the transmitter to a microSD card.
- The models copied in the microSD card can not be used by directly calling from the card. Please copy it to the T4PM main unit when using it.
- If the model data of another transmitter is saved to the microSD card, the model data is not displayed in this list.
- There is no limit to the number of model data on the microSD card, but it differs depending on the capacity size of the card. However, the model data displayed in the list is a maximum of 100 models. In addition, there is no rule in the display order.
- When displaying the copy menu or while executing the copy operation, the buzzer with the same pitch as the key operation may sound continuously, but this is not a malfunction.

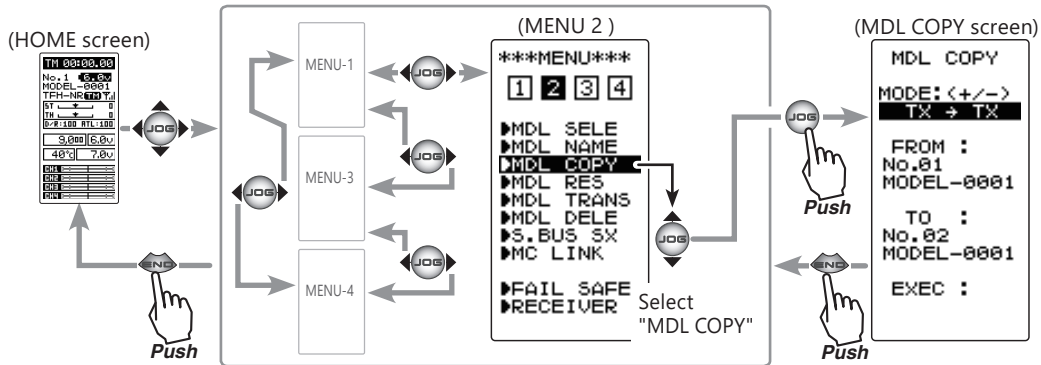

Using the model copy function

1 (Select a mode)

In "MODE", select the copy source and copy destination devices.

Select the setting item "MODE" by moving the (JOG) button up or down. Use the (+) or (-) button and set the copy source and copy destination devices.

- "TX → TX": Copy data from any model to another model on the T4PM main unit.
- "TX → SD": Copy the model data in the T4PM memory to the SD card.
- "SD → TX": Copy the model data in the SD card to the T4PM main unit memory.
- "SD → SD": Make a copy of the model data in the SD card to the same SD card.

MODE

- TX → TX
- TX → SD
- SD → TX
- SD → SD

Select button

- Select with the (+) or (-) buttons.

| | | | |
|--|---|---|--|
| <pre>MDL COPY MODE: <+/-> TX → TX FROM : No.01 MODEL-0001 TO : No.02 MODEL-0001 EXEC :</pre> | <pre>MDL COPY MODE: <+/-> TX → SD FROM : No.01 MODEL-0001 TO : SD CARD EXEC :</pre> | <pre>MDL COPY MODE: <+/-> SD → TX FROM : ----- TO : No.02 MODEL-0001 EXEC :</pre> | <pre>MDL COPY MODE: <+/-> SD → SD FROM : ----- TO : SD CARD EXEC :</pre> |
|--|---|---|--|

If the SD card is not installed or cannot be recognized, (NO SD) is displayed.

EXEC
(NO SD)

2 (Copy source model selection)

Select the setting item "FROM" by moving the (JOG) button up or down, and press the (JOG) button to display a list of model numbers.

- When the copy source is "TX", a list of 1 to 40 models is displayed.
- When the copy source is "SD", the model name is displayed. (If the number of models that do not fit on one page is stored, arrows will be displayed on the left and right of the page number on the screen. (JOG) Move the page by moving the button left or right.)

| | | | |
|--|---|---|---|
| <pre>MDL COPY MODE: <+/-> TX → TX FROM : No.01 MODEL-0001 TO : No.02 MODEL-0001 EXEC :</pre> | <pre>TX MDL No.02 (TFH-nR) MODEL-0001 01 11 21 31 02 12 22 32 03 13 23 33 04 14 24 34 05 15 25 35 06 16 26 36 07 17 27 37 08 18 28 38 09 19 29 39 10 20 30 40</pre> | <pre>MDL COPY MODE: <+/-> SD → TX FROM : ----- TO : No.02 MODEL-0001 EXEC :</pre> | <pre>SD MDL <P 1> MODEL-0001 (00033396) MODEL-0001 (00033433) MODEL-0015 (00033448) MODEL-0025 (00033445) MODEL-0005 (00033457)</pre> |
|--|---|---|---|

Select button

- Select with the (JOG) button.

If there is no T4PM model data on the SD card, (NO FILE) is displayed and the list cannot be displayed.

MDL COPY
MODE: <+/->
SD → TX
FROM :
(NO FILE)
TO :

Select the copy destination model with the (JOG) button up / down or left / right operation, and press the (JOG) button. Return to the copy screen.

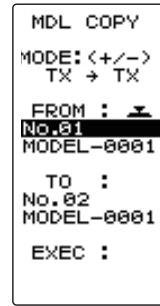

Select button
- Select with the (JOG) button.

3 (Copy destination model selection)

Select the setting item "TO" by moving the (JOG) button up or down, and press the (JOG) button to display a list of model numbers.

-When the destination is "TX", a list of 1 to 40 models is displayed.

-When the copy destination is "SD", the list is not displayed even if the (JOG) button is pressed for additional copying to the SD card.

Select the copy destination model with the (JOG) button up / down or left / right operation, and press the (JOG) button. Return to the copy screen.

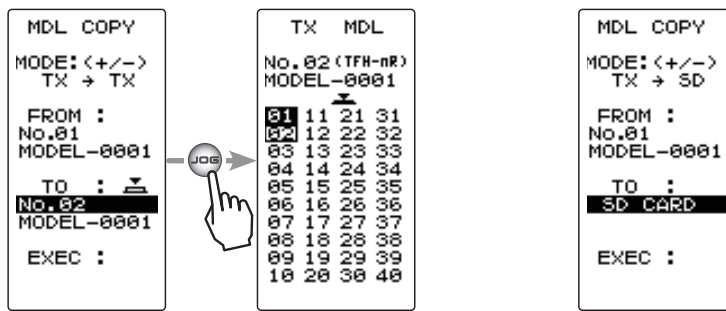

Select button
- Select with the (JOG) button.

4 (Model copy execution)

Select the setting item "EXEC" by moving the (JOG) button up or down, and press the (JOG) button. A beeping sound is generated and the copying is complete.

-Copying is complete when "COMPLETE!" is displayed on the screen.

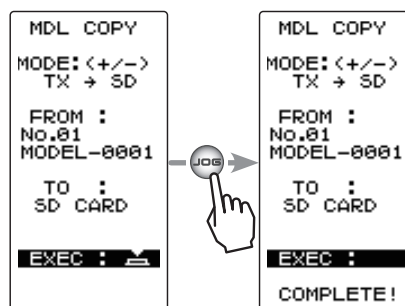

Execution button
- Pressing the (JOG) button.

5 When finished, return to the MENU screen by pressing the (END) button.

Additional function / Model delete (Saved on SD card)

This function deletes model data saved on the SD card.

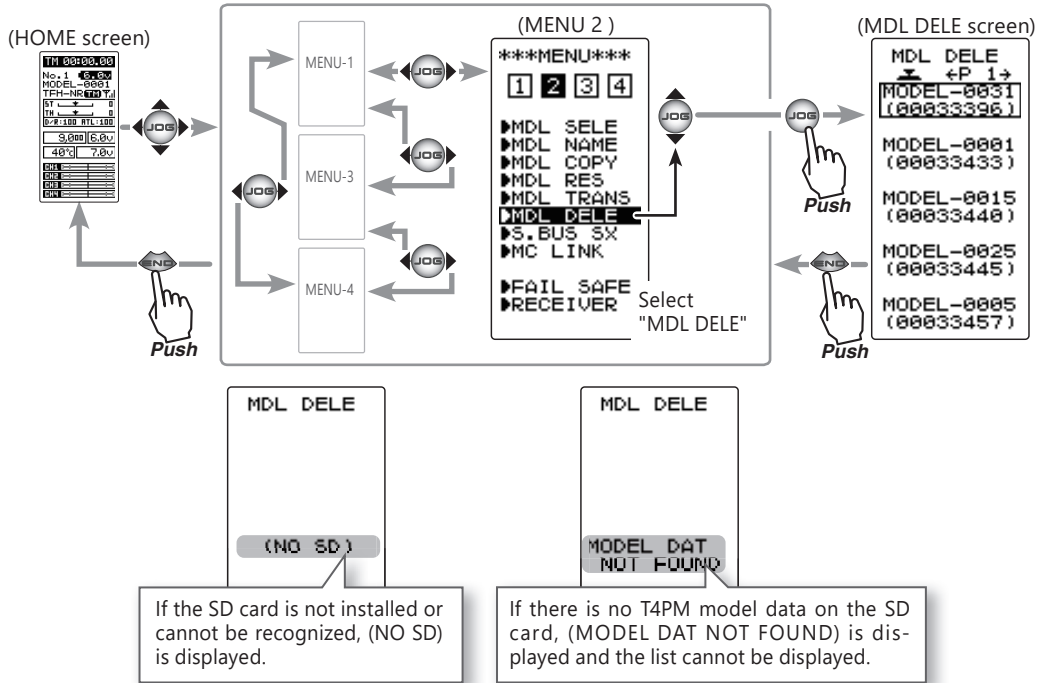

How to delete model data in the SD card

1 (Select model to delete)

Select the model to delete by moving the (JOG) button up or down.

-When the number of models that do not fit on one page is saved, arrows are displayed on the left and right of the page number on the screen. Operate the (JOG) button left or right to move the page.

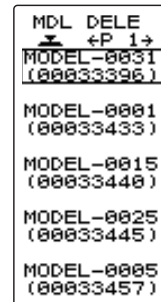

Select button

- Select with the (JOG) button.

2 (Perform delete)

After selecting the model to delete, press the (JOG) button. The message "DELETE ARE YOU SURE?" is displayed. When you press the (JOG) button, a beep sounds and the model data is deleted.

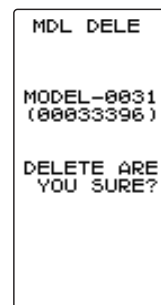

Execution button

- Pressing the (JOG) button.

3 When finished with the setting, return to the MENU screen by pressing the (END) button.

Other

Added support to change SR mode of HPS-CT700.

In the speed function, a setting has been added for the "return" side when returning from the throttle high side to the neutral direction. The setting method is the same as the "return" side of steering speed. Also, a servo operation monitor has been added to the lower side of the screen.

Warning

- Setting the speed function in the return direction slows the deceleration of the car body, so please be careful to set it carefully.

The "RETN" when returning from the throttle high side to the neutral direction.

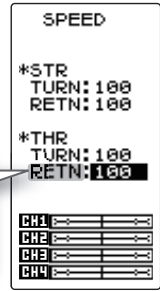

Additional function / The 3/4 Brake Channel Acceleration

If the "Brake mixing" function is being set, the 3rd and 4th channel brake side acceleration will become adjustable.

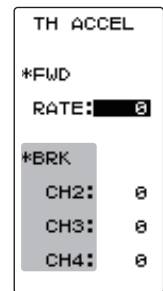
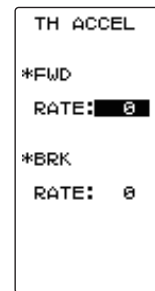

Additional function / Tank Mixing

This function is intended for vehicles such as tanks and can be used for the pivotal turn, or the ultra-pivotal brake turn, by steering and throttle operation.

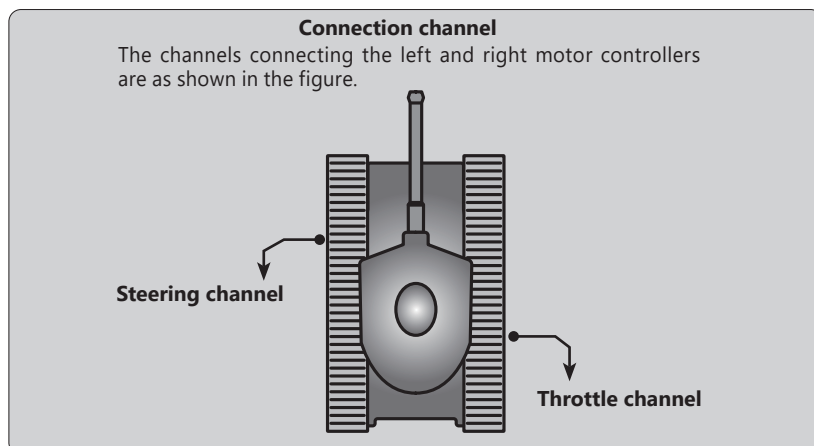
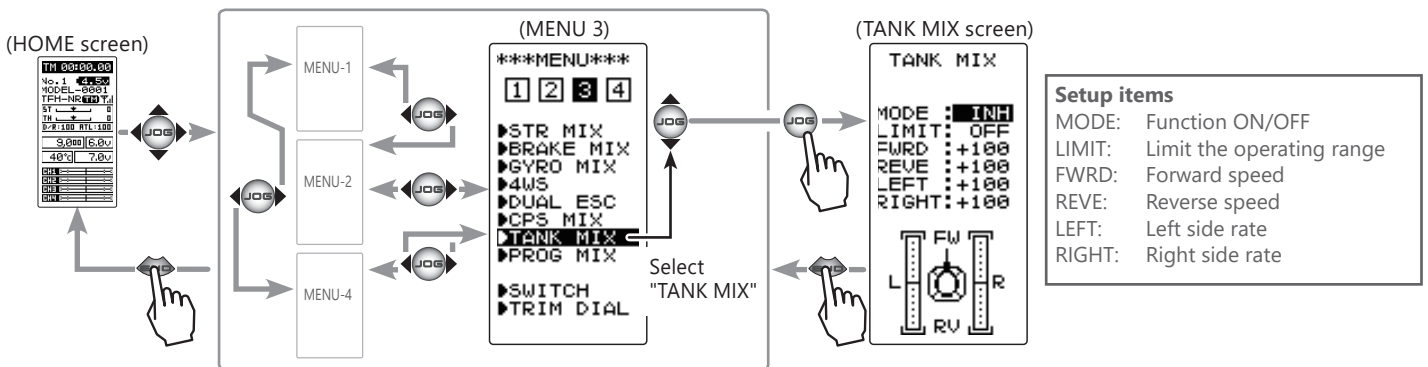

Tank mixing adjustment

1 (Mixing function ON/OFF)

Select the setting item "MODE" by moving the (JOG) button up or down. Use the (+) or (-) button and set the function to the "ON" or "OFF" state.

"INH": Function OFF.

"ON": Function ON.

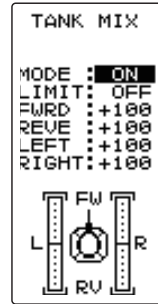

Function ON/OFF (MODE)

INH,ON (OFF)

Select button

- Select with the (+) or (-) buttons.

2 (Limit ON / OFF)

This function limits the maximum operation amount of the steering and throttle channel so that it does not exceed the limit by the influence of the mixing amount. Select the setting item "LIMIT" by moving the (JOG) button up or down. Use the (+) or (-) button and set the function to the "ON" or "OFF" state.

"OFF": Limit function OFF

"ON": Limit function ON

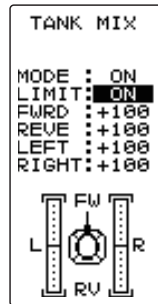

Function ON/OFF (MODE)

INH,ON (OFF)

Select button

- Select with the (+) or (-) buttons.

3 (Forward / backward rate adjustment)

Select the setting item "FWRD" or "REVE" by moving the (JOG) button up or down. Use the (+) and (-) buttons to adjust the forward or reverse speed.

- The throttle channel and the steering channel operate in conjunction with each other, and by operating the trigger to the high side, the car body advances at the "FWRD" rate. When the trigger is operated to the brake side, it operates at the "Back" rate.

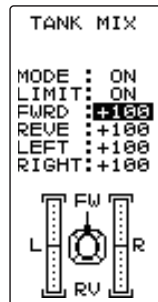

Forward (FWRD)

/ Backward (REVE) rate

-100 ~ +100

Initial value: +100

Adjustment buttons

- Use the (+) and (-) buttons to make adjustments.

- Return to the initial value by pressing the (+) and (-) buttons simultaneously (approx. 1 sec).

4 (Left / Right side travel adjust)

Select the setting item "LEFT" or "RIGHT" by moving the (JOG) button up or down. Use the (+) and (-) buttons to adjust the left or right side travel amount.

- When the throttle channel and the steering channel work in conjunction, when operating the steering wheel to the right, the car body turns to the right at the "RIGHT" rate the pivotal turn. If you operate to the left, the car will turn to the left at the "LEFT" rate the pivotal turn.

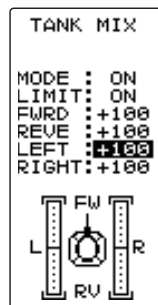

Left (LEFT)

/ Right (RIGHT) rate

-100 ~ +100

Initial value: +100

Adjustment buttons

- Use the (+) and (-) buttons to make adjustments.

- Return to the initial value by pressing the (+) and (-) buttons simultaneously (approx. 1 sec).

5 When finished with the setting, return to the MENU screen by pressing the (END) button.

When steering and trigger are operated at the same time.

If you manipulate the trigger to the high side and operate the steering wheel to the right, the tank will turn right at the rate of "FWRD", "RIGHT".

If you manipulate the trigger to the high side and operate the steering wheel to the left, the tank turns to the left at the rate of "FWRD", "LEFT".

Operating the steering wheel while operating the trigger to the brake side will operate the same as the forward side in the reverse direction.

Additional function / Traction

Trigger operation with cornering on a slippery road surface is hard to get traction and smooth cornering cannot be done. By intermittently pulsing the throttle, you can smoothly navigate and travel on topological lines. Also, with a drift car, by intermittently operating the motor in the high point direction, a pseudo re-verberator engine sound can be reproduced.

Operation

- During throttle operation, the throttle servo is intermittently operated in the forward direction.
- You can set the amount of return to the slow side, the amount of delay, the speed of pumping, the operating point, and the duty ratio of pumping.
- You can choose the action on the slow side near the neutral and the action on the high point side.

Switch setting

Use SW1 or SW2 to switch the traction control function ON/OFF.

Dial / Trim Setting

The throttle return amount, delay amount and cycle speed can be controlled with digital trim DT1 to DT5 or digital dial DL1 etc. with the dial select function.

About Fail Safe Unit

The use of the Futaba fail safe unit (FSU) is similar to the page description of the TH A.B.S function.

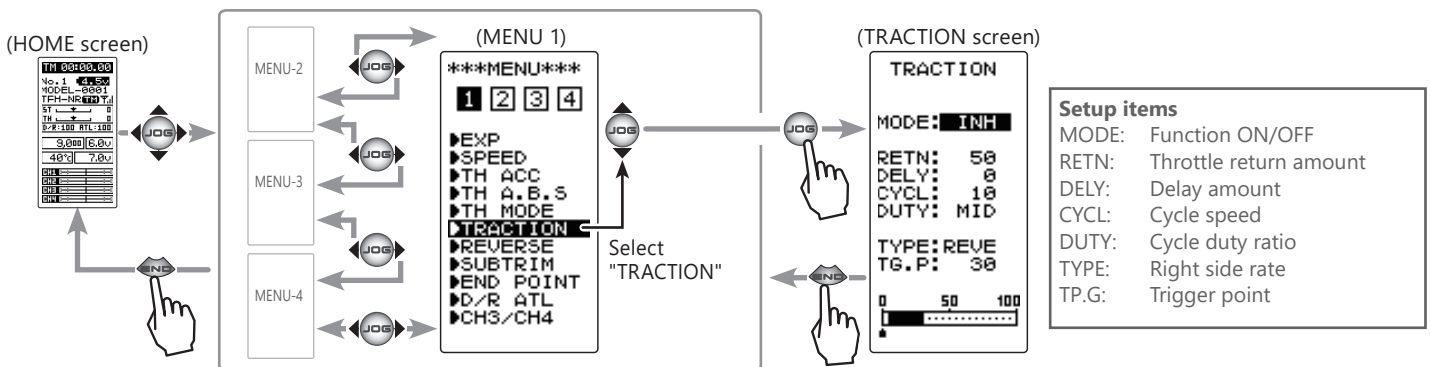

- MODE: Function ON/OFF

Traction control functions ON/OFF setting. When using the Traction control function, set to "ON".

- RETN: Throttle return

Set the ratio at which the servo returns to the slow side with respect to the trigger operation. If set to 0%, the traction control function will not work. At 50%, it returns to the neutral position at 50% (half), 100% of the trigger operation amount.

- DELY: Delay

Set the delay from when the throttle is operated until when the traction control operation starts. When set to 0%, the traction control function works without delay. At 50%, the traction control function works approximately 0.5 second later, and the traction control function works about 1.0 second later at 100%.

- CYCL: Cycle speed

Sets the pulse speed (cycle speed). The smaller the set value, the faster the pulse cycle.

- DUTY: Duty ratio

Set the ratio of the time to operate to the high side and the time to operate to the slow side in the pumping operation. The ratio can be set to HIGH, MID or LOW.

- TG.P: Trigger point / TYPE: Operating range

In the throttle operation, set the position of the trigger at which traction control starts to work. Normal / Reverse, reverse the throttle operation range where the traction control operates, with the trigger point as the boundary.

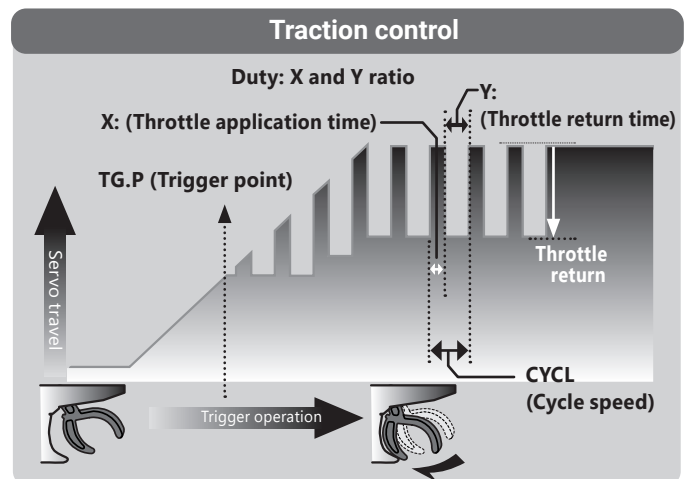

Traction control function adjustment

1 (Function ON/OFF)

Select the setting item "MODE" by moving the (JOG) button up or down. Use the (+) or (-) button and set the function to the "ON" or "OFF" state.

"INH": Function OFF.

"ON": Function ON.

ON(OFF)": Switch OFF when setting switches.

2 ("Throttle return" amount adjustment)

Select the setting item "RETN" by moving the (JOG) button up or down. Use the (+) and (-) buttons to adjust the delay amount.

"0": No return

"50": Return to the 50% position of the brake operation amount

"100": Return to the neutral position.

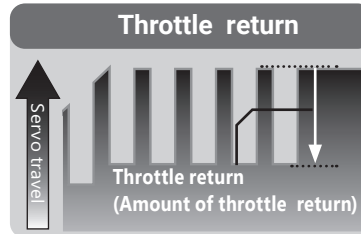

3 ("Delay" amount setup)

Select the setting item "DELY" by moving the (JOG) button up or down. Use the (+) and (-) buttons to adjust the return amount.

"0": Function performed without any delay

"50": Function performed after an approximate 0.5 sec delay.

"100": Function performed after an approximate 1.0 sec delay.

4 ("Cycle speed" adjustment)

Select the setting item "CYCL" by moving the (JOG) button up or down. Use the (+) and (-) buttons to adjust the cycle speed amount.

- The smaller the set value, the faster the pulse speed.

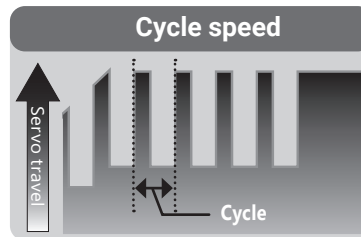

5 ("Duty ratio" setup)

Select the setting item "DUTY" by moving the (JOG) button up or down. Use the (+) and (-) buttons to set the duty ratio.

"LOW": Forward application time becomes shortest.

"HIGH": Forward application time becomes longest.

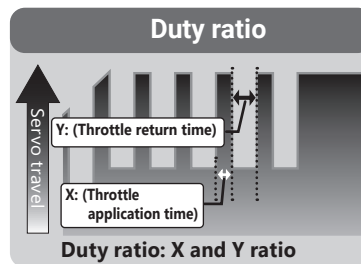

6 ("Trigger point" setup)

Select the setting item "TG.P" by moving the (JOG) button up or down. Use the (+) and (-) buttons to adjust the operation point.

- Sets the throttle trigger position at which the traction control function is performed. The number is the % display with the full throttle position made 100.

Select the setting item "TYPE" by moving the (JOG) button up or down. Use the (+) or (-) button to set the operating range.

"NORM": High range from the trigger point to the operating range.

"REVE": Operating range from neutral to trigger point.

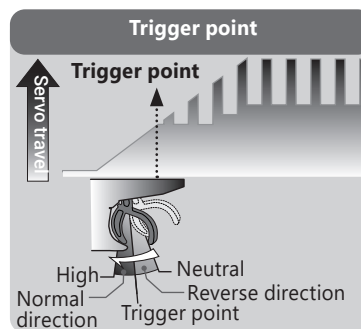

Function ON/OFF (MODE)

INH,ON (OFF)

Select button

- Select with the (+) or (-) buttons.

Throttle return (RETN)

1 ~ -500 ~ 100

Initial value: 50

Adjustment buttons

- Use the (+) and (-) buttons to make adjustments.
- Return to the initial value by pressing the (+) and (-) buttons simultaneously (approx. 1 sec).
- The amount of throttle return varies depending on the EXP setting of the throttle etc.

Delay (DELY)

0 ~ 100

Initial value: 0

Adjustment buttons

- Use the (+) and (-) buttons to make adjustments.
- Return to the initial value by pressing the (+) and (-) buttons simultaneously (approx. 1 sec).

Cycle speed (CYCL)

1 ~ 30

Initial value: 10

Adjustment buttons

- Use the (+) and (-) buttons to make adjustments.
- Return to the initial value by pressing the (+) and (-) buttons simultaneously (approx. 1 sec).

Duty ratio (DUTY)

LOW - MID - HIGH

Initial value: MID

Select button

- Use the (+) and (-) buttons to make adjustments.
- Return to the initial value by pressing the (+) and (-) buttons simultaneously (approx. 1 sec).

Trigger point (TG.P)

5 ~ 95

Initial value: 30

Select button

- Use the (+) and (-) buttons to make adjustments.
- Return to the initial value by pressing the (+) and (-) buttons simultaneously (approx. 1 sec).

Type (TYPE)

NORM, REVE

Select button

- Use the (+) and (-) buttons to make adjustments.

7 When finished with the setting, return to the MENU screen by pressing the (END) button.

Additional function / Resets the sensor slot number

This function is to reset the sensor slot number when using a sensor whose slot number has been changed by another transmitter. Connect the sensor as shown and register according to the following procedure.

Sensor connect

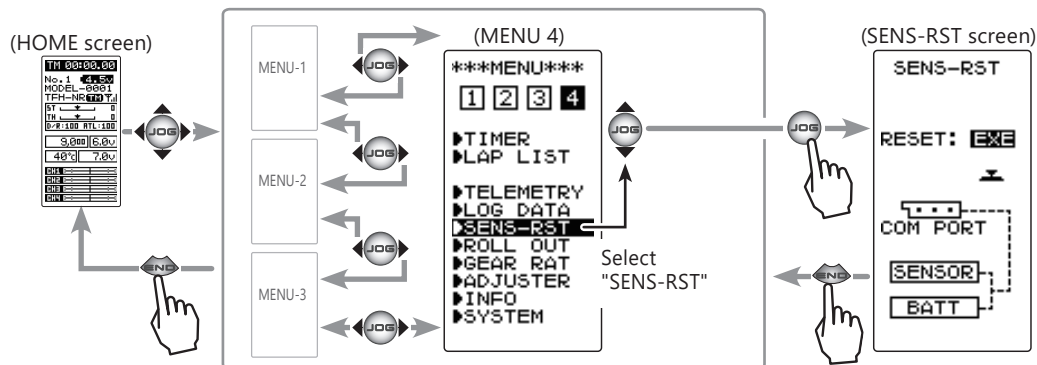
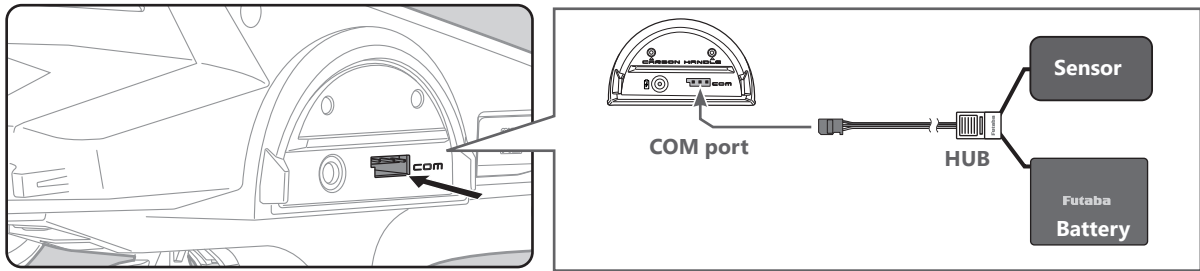

How to reset sensor slot number

1 (Execute reset)

Press the (JOG) button for about 1 second.

- "COMPLETE!" blinks on the screen and reset sensor slot number.

- If "COM-ERROR" blinks on the screen, communication with the sensor is not being performed normally. Check the T4PM and sensor connection and the battery connection to sensor and repeat RESET.

2 When finished with the setting, return to the MENU screen by pressing the (END) button.



Additional function / Roll Out Chart

This function is designed for pan cars. The roll out chart can be calculated from input values for the number of teeth of the spur gear and pinion gear, and the tire diameter, and displayed as a table.

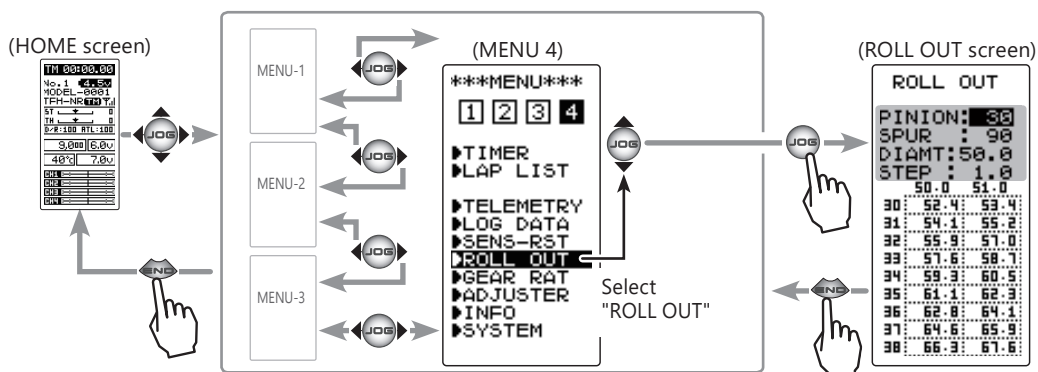

Adjustment buttons

- Use the (+) and (-) buttons to make adjustments.
- Return to the initial value by pressing the (+) and (-) buttons simultaneously (approx. 1 sec).

Use of Roll out chart function

1 (Setting of step of the tire diameter input)

Select the setting item "STEP" by moving the (JOG) button up or down. Use the (+) and (-) buttons to set the step of input numerical value of tire diameter amount.

-The step amount can be set in the range of 0.1 mm to 1.0 mm.

- 2 (Setting of number of teeth of spur gear)
Select the setting item "SPUR" by moving the (JOG) button up or down. Use the (+) and (-) buttons to set the spur gear. The roll out is then calculated, and the list is updated.
- 3 (Setting of number of teeth of pinion gear)
Select the setting item "PINION" by moving the (JOG) button up or down. Use the (+) and (-) buttons to set the pinion gear. The roll out is then calculated, and the list is updated.
- 4 (Setting of tire diameter)
Select the setting item "DIAMT" by moving the (JOG) button up or down. Use the (+) and (-) buttons to set the tire diameter. The roll out is then calculated, and the list is updated.
- 5 When finished with the setting, return to the MENU screen by pressing the (END) button.

Additional function / Gear Ratio Chart

The Gear Ratio Chart can be calculated from input values for the number of teeth of the spur gear and pinion gear, and secondary gear ratio, and displayed as a table.

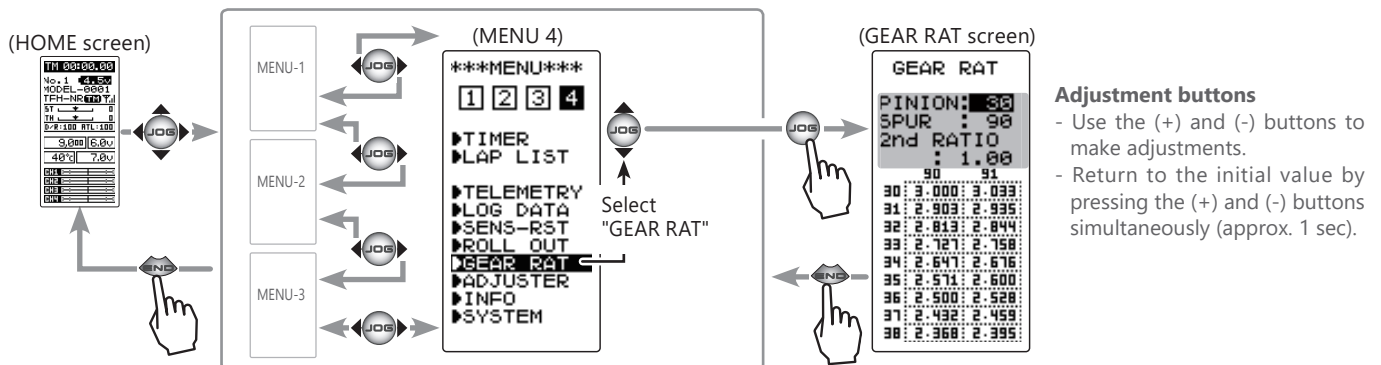

Use of Gear ratio chart function

- 1 (Setting of number of teeth of pinion gear)
Select the setting item "PINION" by moving the (JOG) button up or down. Use the (+) and (-) buttons to set the pinion gear. The roll out is then calculated, and the list is updated.
- 2 (Setting of number of teeth of spur gear)
Select the setting item "SPUR" by moving the (JOG) button up or down. Use the (+) and (-) buttons to set the spur gear. The roll out is then calculated, and the list is updated.
- 3 (Setting of number of secondary gear ratio)
Select the setting item "2nd RATIO" by moving the (JOG) button up or down. Use the (+) and (-) buttons to set the 2nd gear ratio. The roll out is then calculated, and the list is updated.
- 4 When finished with the setting, return to the MENU screen by pressing the (END) button.