

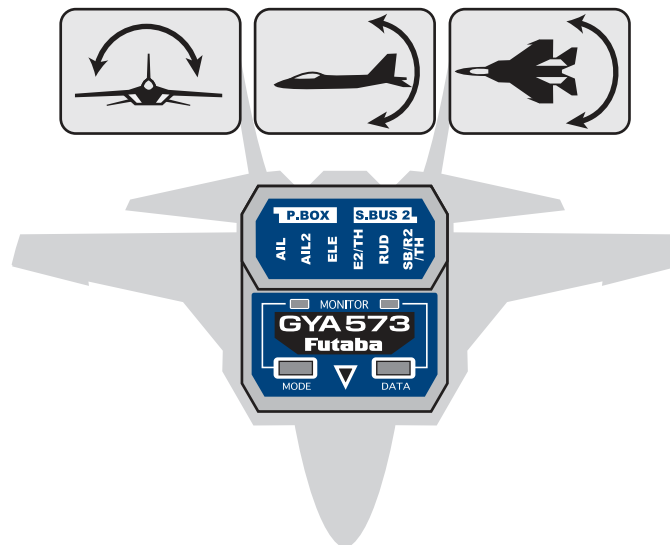

# T32MZ

# GYA573



**T32MZ(WC) Ver.4.7**

**GYA573 Ver.7.x**

**Setting manual**

1M23Z08530

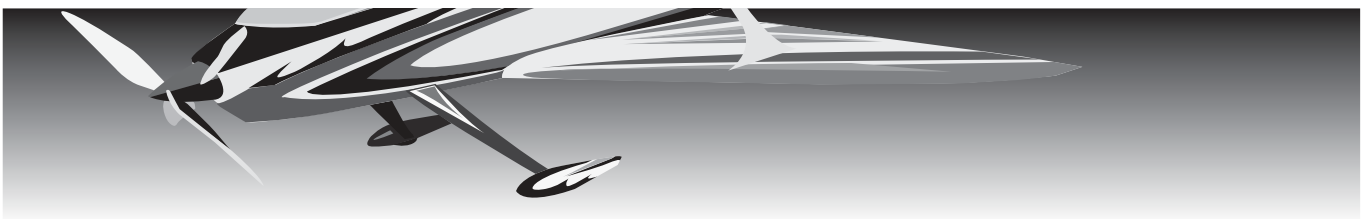

By installing the latest software on the T32MZ(WC), you can setting the airplane gyro GYA573 on the T32MZ(WC).

Connection T32MZ(WC) and GYA

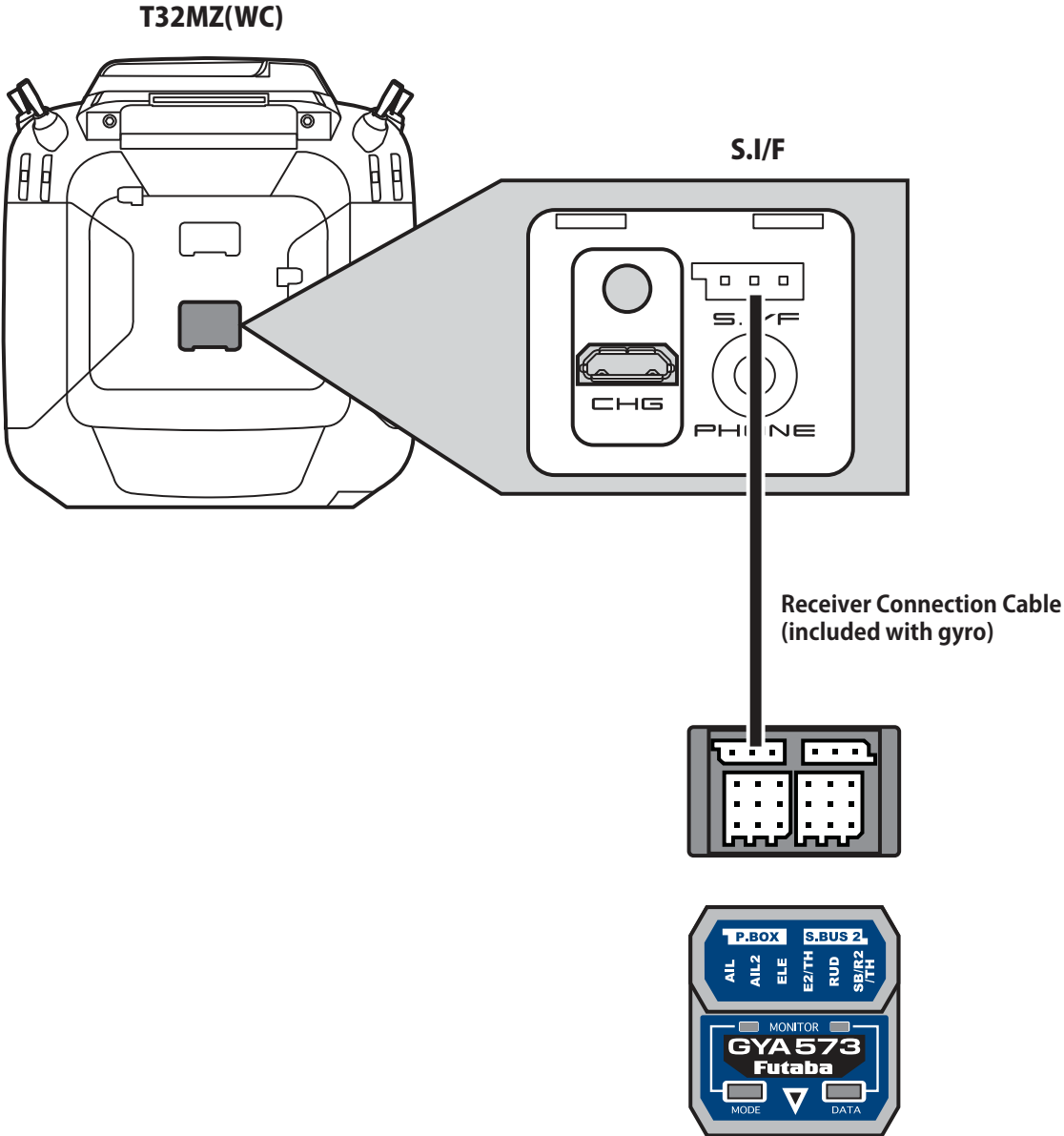

**CAUTION**

Be sure to connect and disconnect the GYA and T32MZ(WC) connection cable with the power off.

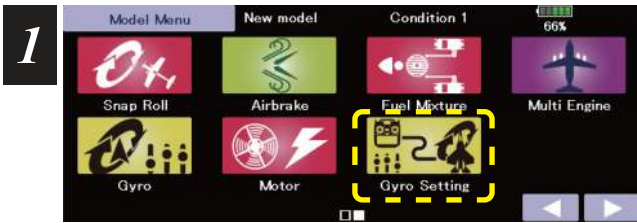

1. Select "Gyro setting" on the last page of Airplane Model Menu

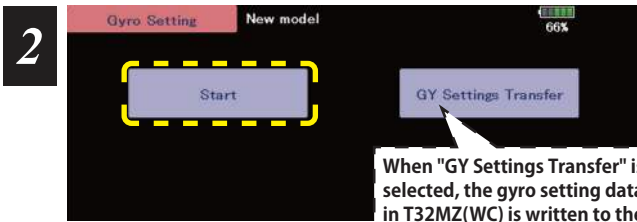

2. Select "Start"

When "GY Settings Transfer" is selected, the gyro setting data saved in T32MZ(WC) is written to the gyro.

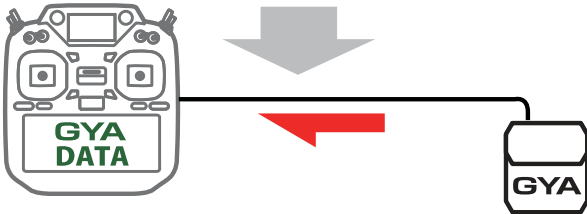
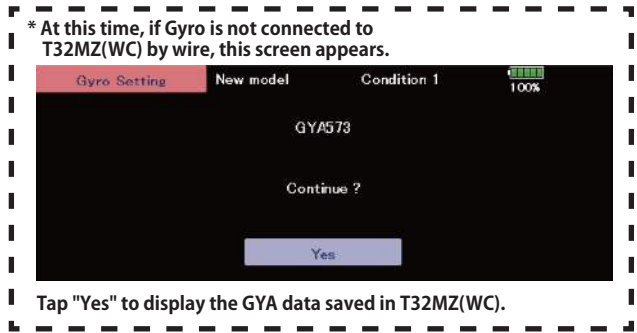

Select "Start"  
This will download the gyro data to the T32MZ(WC).

- \* CGY helicopter gyro data cannot be written to GYA airplane gyro data.
- \* GYA573 data cannot be written to GYA553.
- \* Data from other models cannot be written to GYA573.
- \* Once writing is complete, turn the gyro off and then on again. The data for the added functions will be deployed.

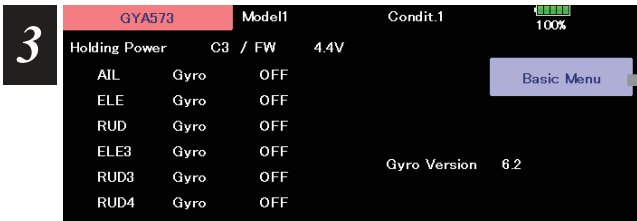

3. Home screen is displayed

To Basic menu

## ◆ When copying data from Gyro A to Gyro B

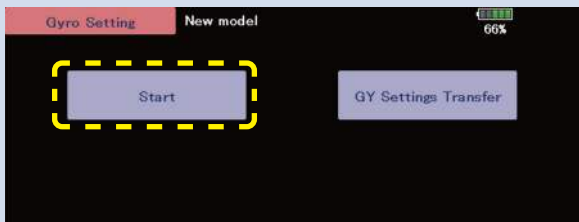

Connect the gyro A to the T32MZ(WC) and press [Start]. (Enter the data of A into T32MZ(WC))

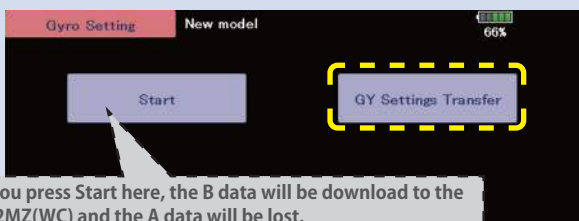
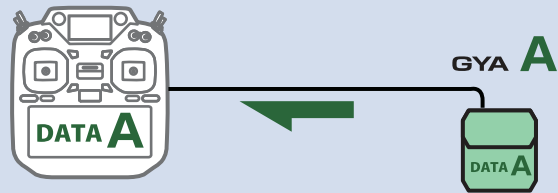

If you press Start here, the B data will be download to the T32MZ(WC) and the A data will be lost.

Connect Gyro B to T32MZ(WC) and press [GY Settings Transfer]. (Put data on A into gyro B)

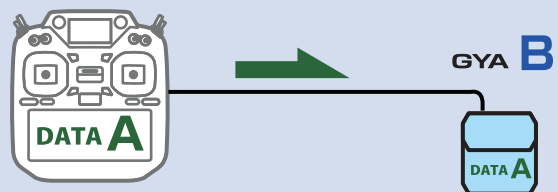

## Home screen

On the home screen, basic information such as gyro operation mode, sensitivity, battery voltage are displayed.

### Gyro operation mode / Gyro gain

Displays "AVCS" or "Normal" operation mode and gyro gain of aileron (roll), elevator (pitch) and rudder (yaw) axis.

### Model name display

Displays the model name (GYA553 or GYA573) of the loaded data.

### Battery voltage

Displays the voltage of the receiver battery connected to GYA.

### GYA Software version

The software version of the connected GYA is displayed.

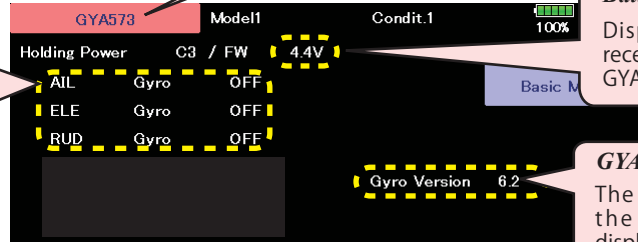

## Basic menu for GYA573

### Home screen

### When vector nozzle settings are configured

When the ELE3 and RUD3,4 operation channels are set, the gyro gain settings for ELE3 and RUD3,4 are displayed.

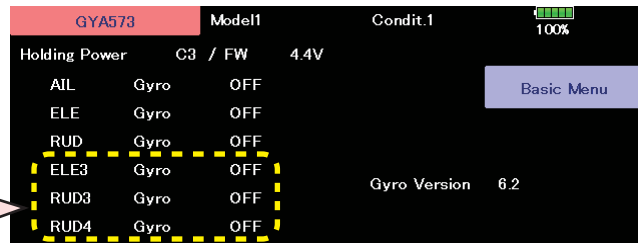

### Basic menu

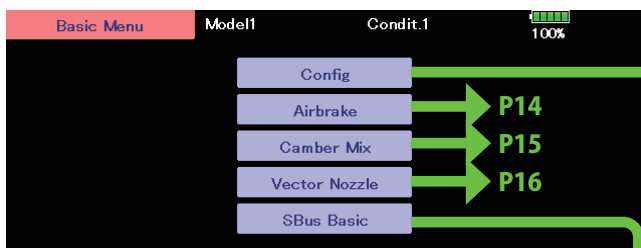

### ◆ Config

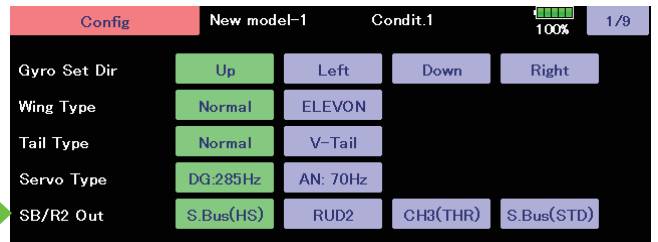

### ◆ S.BUS basic

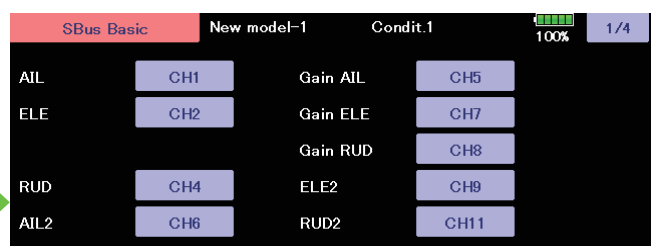

## Config 1/9 Gyro set mounting direction

Config	New model-1		Condit.1	100%	1/9
Gyro Set Dir	Up	Left	Down	Right	
Wing Type	Normal	ELEVON			
Tail Type	Normal	V-Tail			
Servo Type	DG:285Hz	AN: 70Hz			
SB/R2 Out	S.Bus(S/S)	RUD2	CH3(THR)	S.Bus(STD)	

Set the mounting direction of GYA. Set mounting direction with reference to figure below.

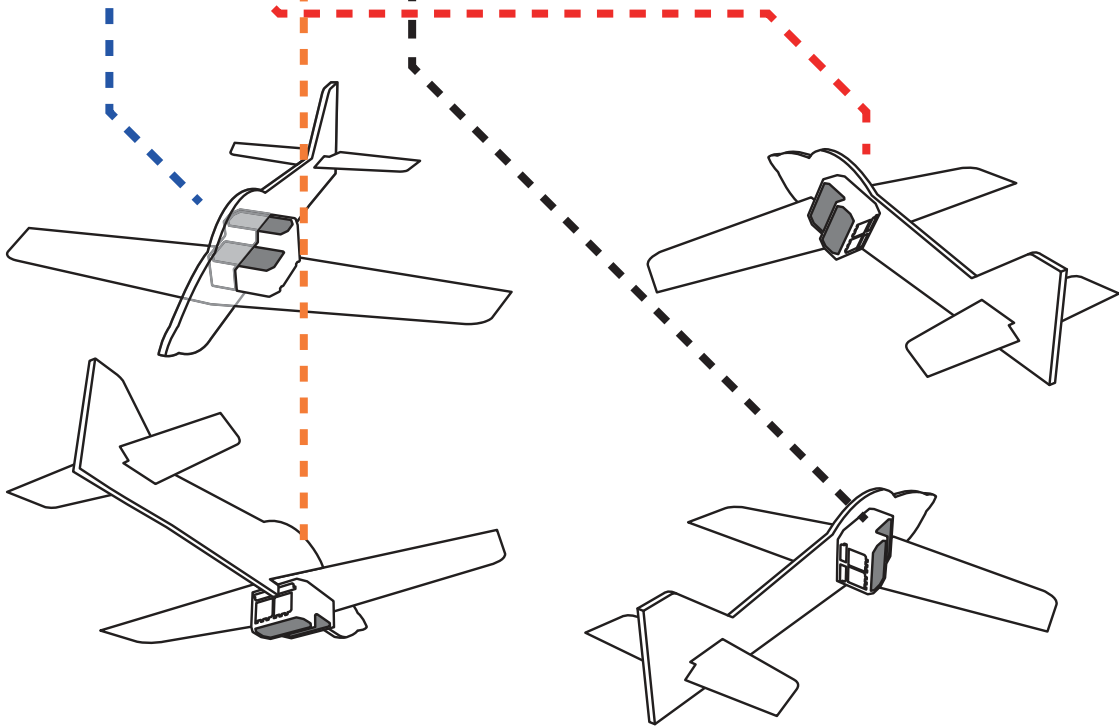

## Config 1/9 WING/TAIL

Set with the wing type/tail type of GYA. The wing type/tail type of the transmitter is not used and is normal.

- Turn off the elevon/V-tail mixing on the transmitter side.
- Do not use transmitter sub-trim. Adjust using the gyro neutral offset.
- When using the S.BUS servo, you can also use the neutral offset function of the S.BUS servo setting parameters.

Config	New model-1		Condit.1	100%	1/9
Gyro Set Dir	Up	Left	Down	Right	
Wing Type	Normal	ELEVON			
Tail Type	Normal	V-Tail			
Servo Type	DG:285Hz	AN: 70Hz			
SB/R2 Out	S.Bus(S/S)	RUD2	CH3(THR)	S.Bus(STD)	

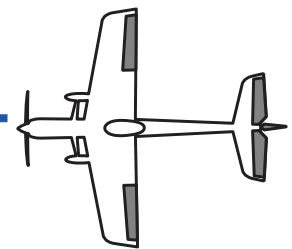

Select wing type

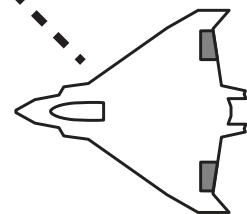

Select tail type



# Config

## Config 1/9 Servo type



Digital servo

Analog servo

Select the servo type according to the servo to be used.

**Digital servo → DG : 285 Hz**

**Analog servo → AN : 70 Hz**

The stability of digital-servo mode of a flight increases in order to perform a high-speed control action.

## Config 1/9 SB/R2 OUT

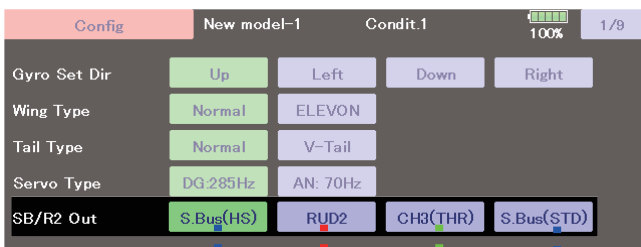

Select the SB/R2 port.

**S.BUS(HS)**  
Connect SV servo

**Rudder 2**

**Throttle**

**S.BUS(STD)**

If S3175HV, DLPH-1, etc. do not work with S.BUS(HS), use S.BUS(STD).

When using two rudder servos

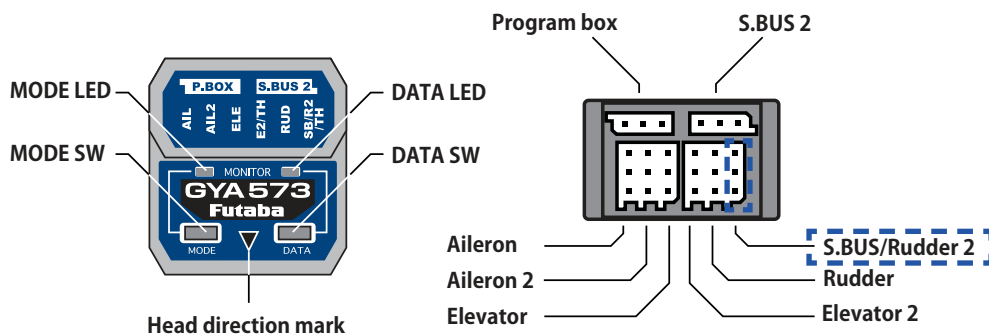

# Config

## Config 2/9 Gyro direction

It is the direction setting of the gyro. Be careful as it will crash if the direction is reversed.

For dual aileron, dual elevator, and dual rudder aircraft, check the operating direction of each second aileron/elevator/rudder.

Config	New model	Condition1	100%	2/9
<b>Gyro Dir</b>				
AIL	Normal	AIL2	Normal	
ELE	Normal	ELE2	Normal	
RUD	Normal	RUD2	Normal	
AIL3	Normal	AIL4	Normal	

Tilt the airplane to the left on the ground and check that the ailerons operate to the right.

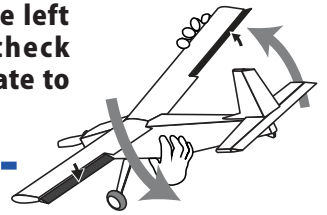

Tilt the airplane to the left on the ground and check that the 4-aileron operate to the right.

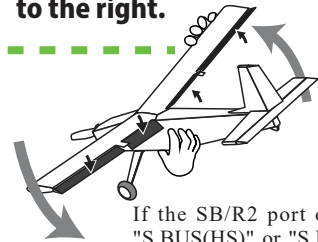

If the SB/R2 port output is set to "S.BUS(HS)" or "S.BUS(STD)", the setting menu will display AIL3 and AIL4 setting items.

\* AIL3 and AIL4 settings cannot be set with the button settings on the GYA main unit.

Turn the airplane to the right on the ground and check that the rudder operates to the left.

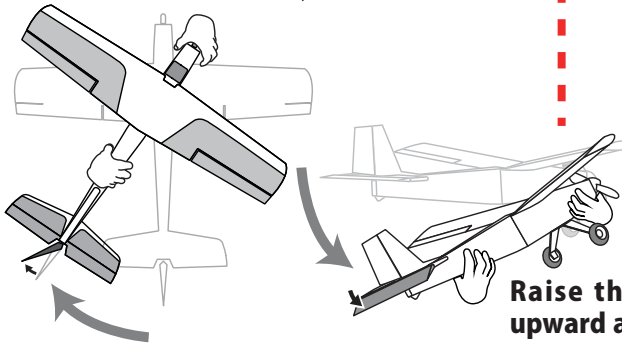

Raise the airplane with its nose upward and check that the elevator operates downward.

## Config 3/9 Neutral offset

Config	New model	Condition1	100%	3/9
<b>Neutral Offset</b>				
AIL	+0	AIL2	+0	
ELE	+0	ELE2	+0	
RUD	+0	RUD2	+0	
AIL3	+0	AIL4	+0	

Neutral position setting for each servo.

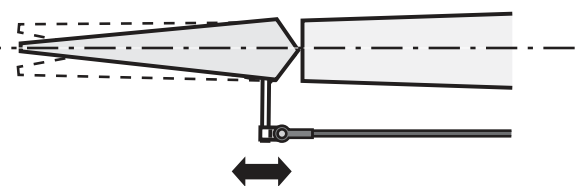
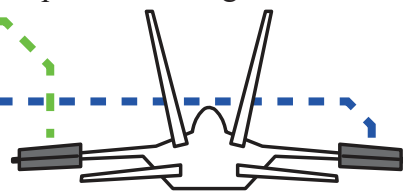

This will move the neutral to the desired position.

If the SB/R2 port output is set to "S.BUS(HS)" or "S.BUS(STD)", the setting menu will display AIL3 and AIL4 setting items.

\* AIL3 and AIL4 settings cannot be set with the button settings on the GYA main unit.

## Config 4/9 5/9 Servo limit



This is the limit setting for each servo. The position of the maximum operation is read into the gyro in the first setting.



If the SB/R2 port output is set to "S.BUS(HS)" or "S.BUS(STD)", the setting menu will display AIL3 and AIL4 setting items.

\* AIL3 and AIL4 settings cannot be set with the button settings on the GYA main unit.

### Aileron example

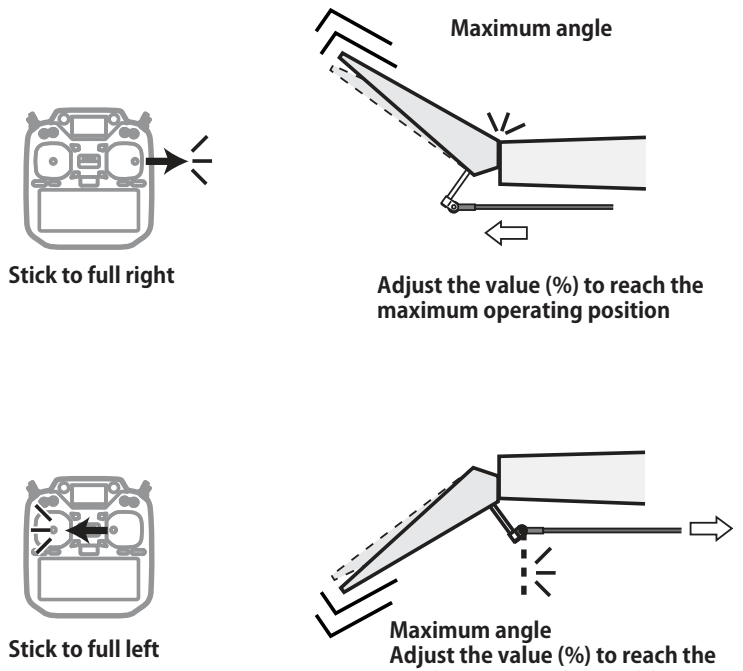

**Config 6/9 Holding Power**

It is a function to adjust the posture holding force of the aircraft in AVCS mode. Decreasing the value weakens the holding power and makes the operation feeling closer to the normal mode.

The current rate numbers C1 to C5 are displayed by operating the channel of the transmitter. Like the flight condition function of the transmitter, you can set up to 5 different data for the attitude holding force rate of the aircraft in AVCS mode by operating the switch from the transmitter, and switch between them. You can set the holding power rate selector switch to the channel with the AFR function of the transmitter, and set the point for each rate on the AFR point curve to switch. It is also possible to use the flight condition function to work with the flight condition switch.

**Config 6/9**

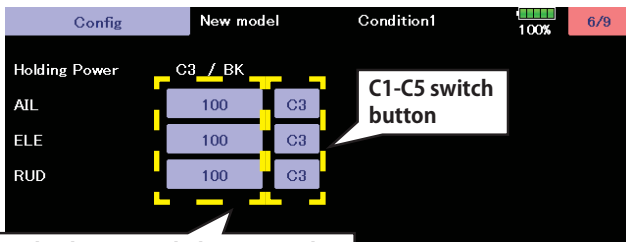

With the switch button, the "holding power" of each rate (C1 to C5) can be displayed and adjusted.

**S.BUS Basic 2/4**

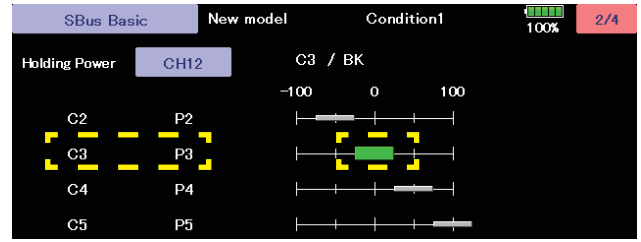

By operating the channel of the transmitter, the channel position of the current rate numbers C1 to C5 will be displayed in green.

Display and adjust the current rate numbers C1 to C5 by operating the channel on the transmitter.

When set to SW of DG1 or DG2

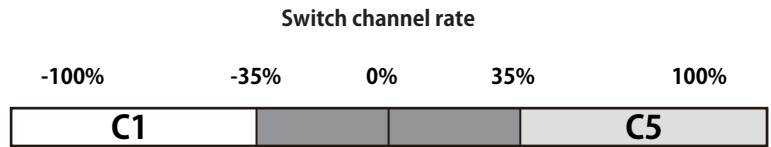
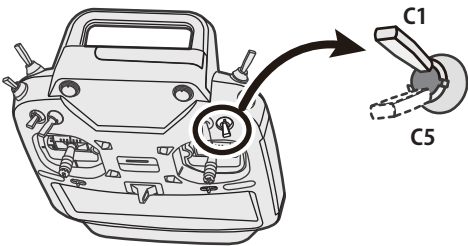

When set to dial or lever

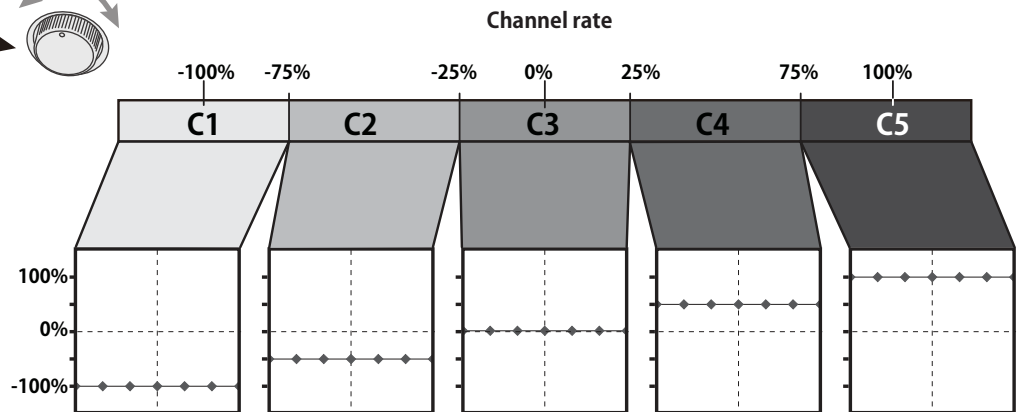
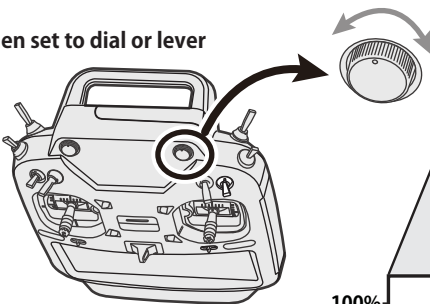

## Config 7/9 4D Flight (Backward flight) Gyro Reverse Mode Adjustment

Page 7 is for setting the gyro reverse mode. This is a special setting for 4D backward flight. Select whether to reverse the control direction of the aileron, elevator, and rudder when flying backward. Normally, when flying backward, the steering direction of all the rudder is reversed, so the control direction of the gyro is also reversed.

Switching between forward (FW) and reverse (BK) uses the same CH12 signal as the holding force. Up from near the midpoint of the throttle stick is forward, and down is reverse.

For details on setting the switching point, please refer to the transmitter settings.

In gyro reverse mode, the gyro controls in the same direction as the aircraft's tilt. Switch between forward and reverse to check that the gyro control direction changes correctly.

**Config 7/9**

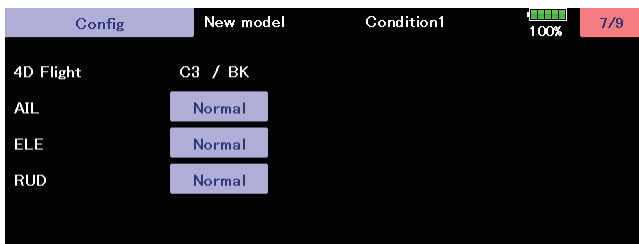

**S.BUS Basic 3/4**

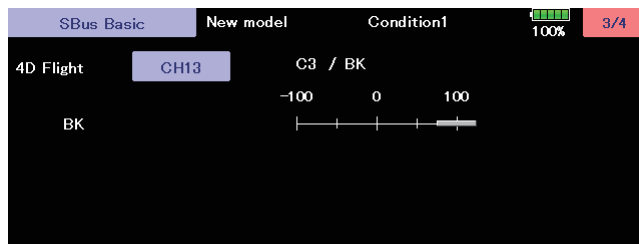

## Config 8/9 4D Flight (Backward flight) Mode Adjustment

Page 8 is for setting the gyro reverse mode. This is a special setting for 4D backward flight.

The AET (BK) and AET (FW) functions estimate the aircraft's flight attitude during forward and backward transitions and optimize gyro control. If the aircraft's attitude changes quickly, decrease the value. If the attitude changes slowly, increase the value. The correction values for forward and backward transitions can be set independently. The setting range is 0 to 30. The OPC parameter adjusts the speed when the control amount increases and decreases. The setting range is 0 to 27. The values in the setting example are the standard setting values for SkyLeaf-ST. The optimal value will vary depending on the aircraft characteristics and flight style.

**Config 8/9**



Pages 7-8 are for 4D backward flight settings. For detailed settings, refer to the GYA 4D Flight Setting Manual on the Futaba WEB site.

## Config 9/9 Reset

### Config 9/9



E2/TH port can be set to ELE2 output or CH3 (THR) output.

Reset each Config item. It returns to the initial value.



For GYA573, the settings for the air brake, camber mix, and vector nozzles will also be reset.

## SBUS Basic menu

Set the CH for each function according to the transmitter to be used. Any unused functions should be set to INH (Inhibited).

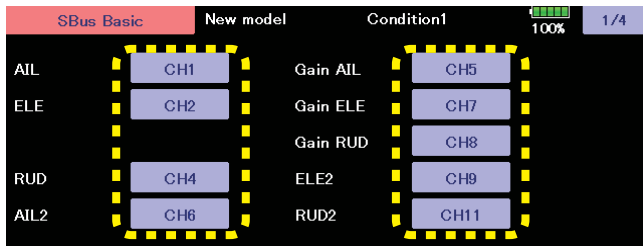

### ⚠ WARNING

Always verify that the S.BUS function assignments match your transmitter's function (in the FUNCTION menu) assignments. If any changes are made within the transmitter function assignments, then it will also be necessary to make the changes within the S.BUS function assignments. To change the channel, GYA and T32MZ(WC) must be connected.

The channel of each function can be changed.

Tap to move to the rate switching CH setting page.

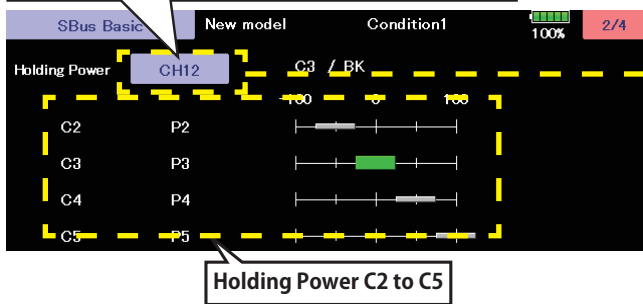

Holding Power C2 to C5

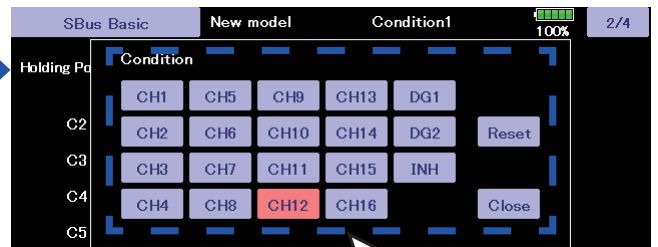

Tap the CH used for rate switching to select it.

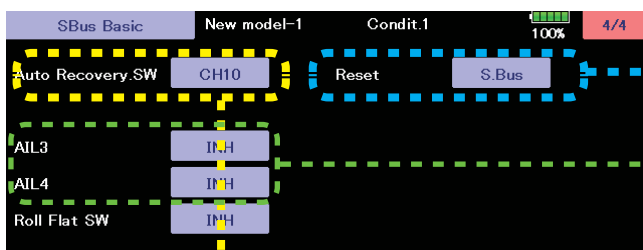
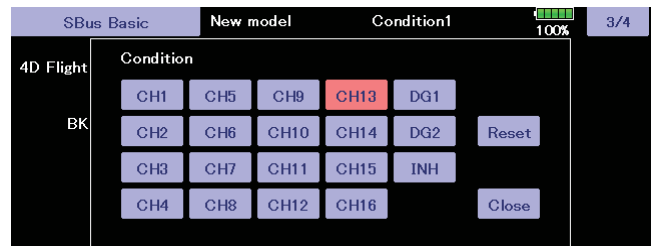
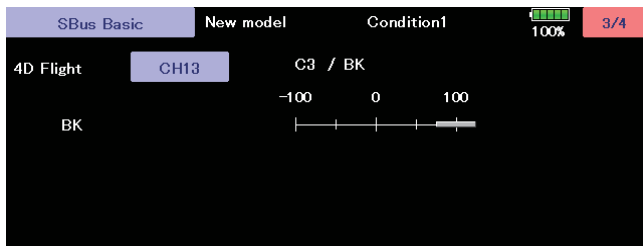

**ON-OFF channel for auto recovery**

**Reset each S.BUS function. It returns to the initial value.**

CH setting items for AIL3 and AIL4 are displayed on the final screen of the S.BUS basic setting screen. By setting the operation CH of AIL3 and AIL4, the gyro-controlled signal is output to the corresponding CH of the S.BUS output.

- \* Match the operation CH and CH setting on the function setting screen on the transmitter side.
- \* When the AIL3 and AIL4 CH settings are INH, the gyro control is not performed and the data sent from the transmitter is output as is.

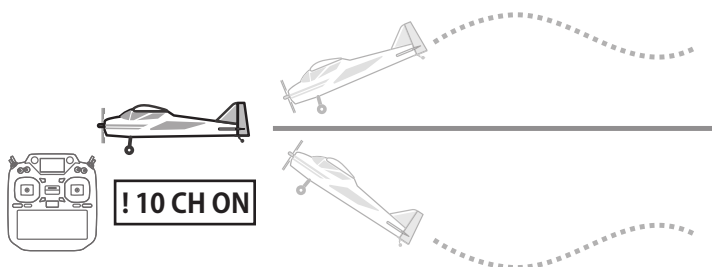

## SBUS Basic menu

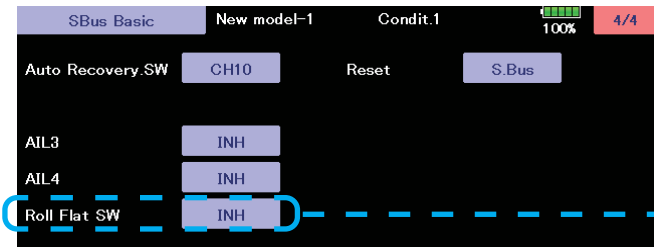

This is the channel setting for the switch that turns roll flat ON/OFF.

The roll angle at which roll flat turns ON can be set by the pulse width at the ON position.

(Set using the AFR rate on the transmitter for this setting CH, etc.)

### 【Roll Flat】

This function keeps only the roll axis horizontal (roll angle  $0^\circ$  ).

When used during landing approach, it keeps the roll axis horizontal, making aileron operation easier and allowing you to concentrate on throttle and elevator operation, making landing easier. It also maintains horizontality during inverted flight. The roll angle at which the roll flat function turns on should be set to  $10^\circ$  to  $15^\circ$  during landing, and  $15^\circ$  to  $20^\circ$  during normal flight, for a smooth flight.

Conditions for the roll flat function to be ON (when all of the following conditions are met)

- 1) Roll Flat Switch Channel is set (not INH)
- 2) When the roll flat switch channel is in the - position from neutral when viewed on the transmitter AFR setting screen.
- 3) When the roll flat switch channel operation position is viewed on the AFR setting screen of the transmitter, when the rate value is  $Wp$  (%), the roll angle of the aircraft is within  $Wp/2$  (degrees).
- 4) When the aileron stick is in the neutral position.
- 5) When the aircraft pitch angle is  $\pm 60^\circ$  or less

**【EX.】** When the roll flat switch channel is CH15, if the operating position of CH15 is the AFR rate -50%, the roll angle at which the roll flat function will be turned ON will be within  $\pm 25^\circ$

When the Roll Flat Switch Channel is set to an AFR rate of -100% or less, the auto recovery mode operates.



When the roll flat switch channel is in the - rate side from neutral, the roll flat function becomes ACT.

The roll angle at which roll flat is ON is 1/2 the AFR rate of the roll flat switch channel operating position.

**【EX.】** When the AFR rate of the roll flat switch channel operating position is -50%, if the roll angle is within  $\pm 25^\circ$  , the roll flat function is ON.

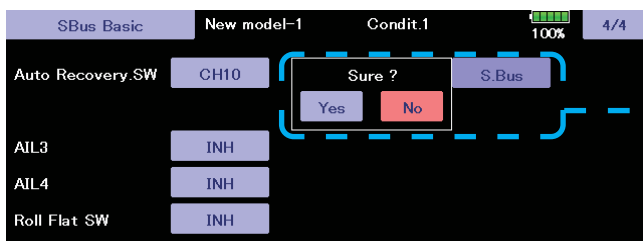

Reset the S.BUS basic items. After execution, the items will return to the factory default values.

Tap "Reset" and then "Yes" on the confirmation screen to reset to the initial value.

## Air Brake

This function is the same as the air brake function of the transmitter. Two rates, A1 and A2, can be set. (The amount of operation is slightly less than that of the air brake function of the transmitter. It can also be used in AVCS mode where the air brake function of the transmitter cannot be used.)

Roll Flat function works even when the air brake is on.

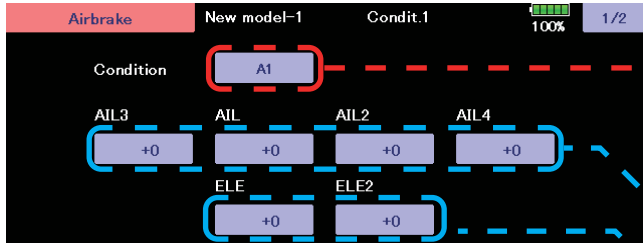

### Air brake mix rate No. display

The air brake can be set to two rates: A1 and A2.

### Operation rate (-250 ~ 0 ~ +250)

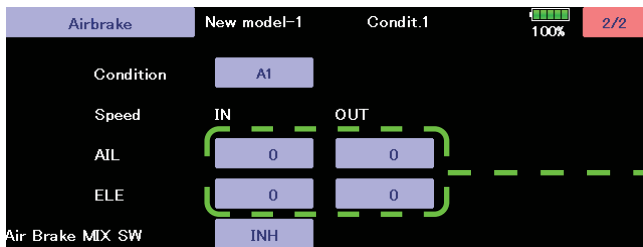
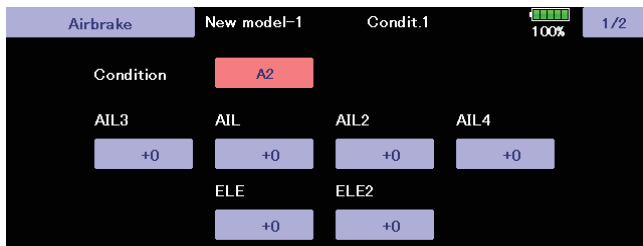

### Setting the operating speed of each servo Setting range : 0 ~ 27

IN is the operating speed when the air brake mix is turned ON.

OUT is the speed when the air brake mix is turned OFF.

When switching between A1 ⇔ A2, the speed setting of the one that is turned ON (IN side) takes priority.

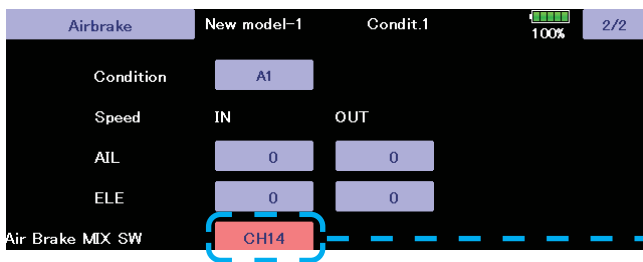

### Air brake Mix ON/OFF CH setting

#### Setting range: INH, CH1-CH16, DG1, DG2

A1 and A2 rates change with the pulse width of the same CH

Set with AFR on the transmitter

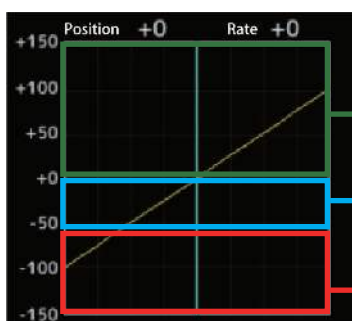

A1 and A2 are in the OFF region (neutral to +rate side)

Area where A1 is ON and A2 is OFF ((neutral to -50% side)

Area where A1 is OFF and A2 is ON (-50% or less)

## Camber mixing

This function is equivalent to the camber mixing function of the transmitter.

It can also be used in AVCS mode where the transmitter's camber mixing function cannot be used.

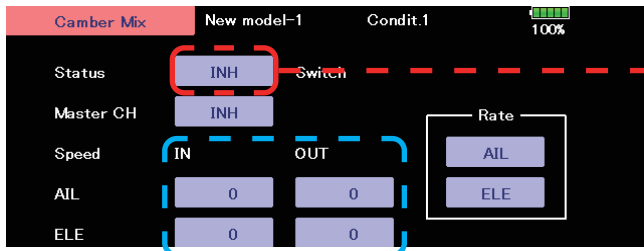

### Camber Mix ON/OFF setting

**[Display]**

**INH** : Inhibit

**OFF** : Camber Mix is ACT, but Master CH is not set

**ON** : Camber Mix is set to ACT and the master channel is also set, but the ON/OFF channel is not set (Mixing is active).

**ACT** : Camber Mix is set to ACT with both the master channel and the ON/OFF channel set.

### Camber Mix operation speed setting (0 to 27)

**Mixing OFF** ⇒ When ON or when the master CH is operated while ON, it operates at the IN side rate.

**Mixing ON** ⇒ When OFF, it operates at the OUT side rate



Area where camber switch is ON (-50% or less)

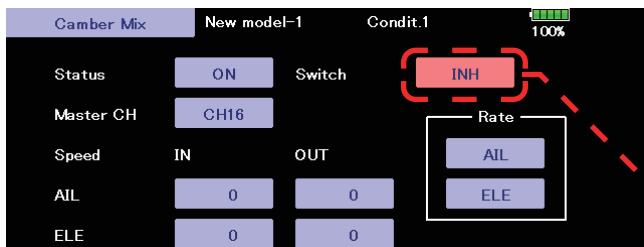

### Camber Mix ON/OFF CH setting

**Range** : INH, CH1-CH16, DG1, DG2

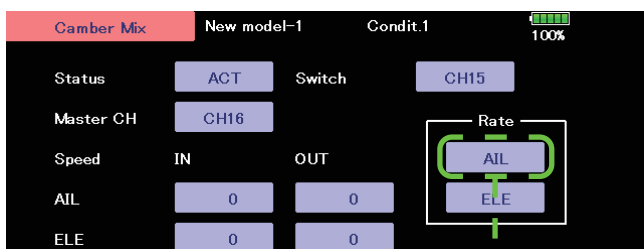

AIL setting screen transition button

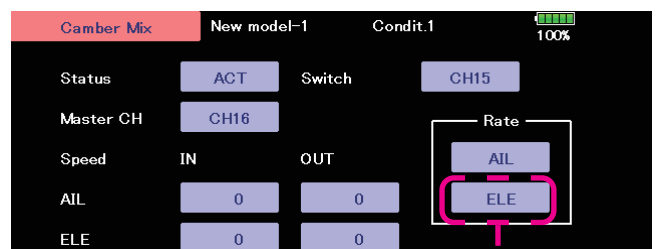

ELE setting screen transition button



**AIL Operation Rate (-200 ~ 0 ~ +200)**  
Up and down sides can be set separately

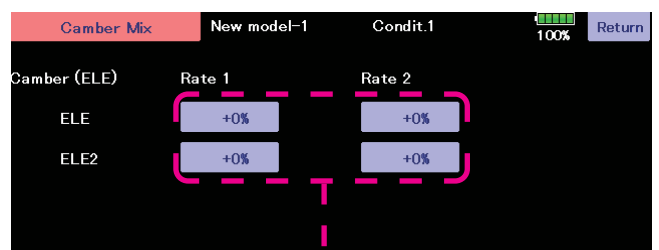

**ELE Operation Rate (-200 ~ 0 ~ +200)**  
Up and down sides can be set separately

## Vector nozzle function settings

This function is for aircraft that can change the direction of rear thrust (pitch axis and yaw axis), such as the latest jet models. The direction of the vector nozzle is controlled by a gyro.

\*Vector nozzle control requires S.BUS servo or servo connected to S.BUS decoder such as DLPH.

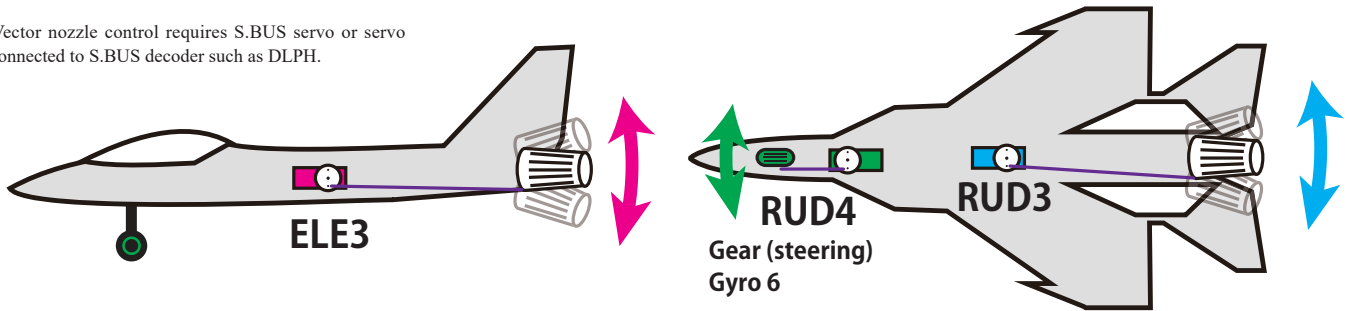

### 1. Vector nozzle function in ACT

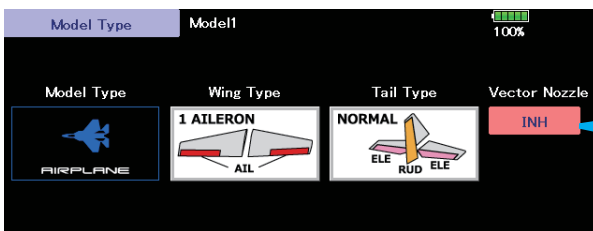

Call the **Model type**.

Vector Nozzle button is added to Model Type menu screen.

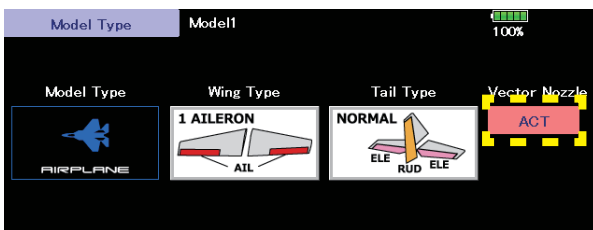

Tap **INH** on the vector nozzle to **ACT**.

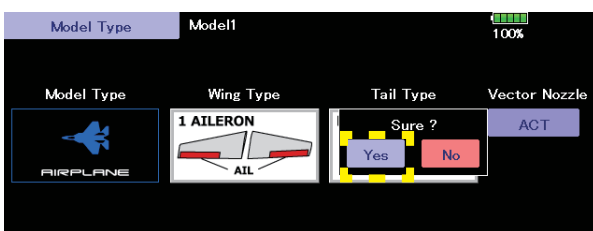

A confirmation screen will appear, so tap **"Yes"**.

When Vector Nozzle button is ACT, some AUX functions is renamed for Vector Nozzle gyro operation.

Function Name							
Please select a function.							
Aileron	Elevator	Throttle	Rudder	Gear	Flap	Aileron2	Aileron3
Aileron4	Elevator2	Flap2	Air Brake	Fuel-Mix	Gyro	Gyro2	Gyro3
Throttle2	Throttle3	Throttle4	Flap3	Flap4	Rudder2		Camber
Motor	Gyro4	Gyro5	Elevator3	Rudder3	Gyro6	Rudder4	Auxiliary 1

## 2 Operation function settings

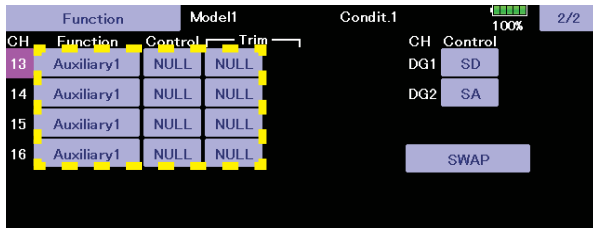

Call the function.

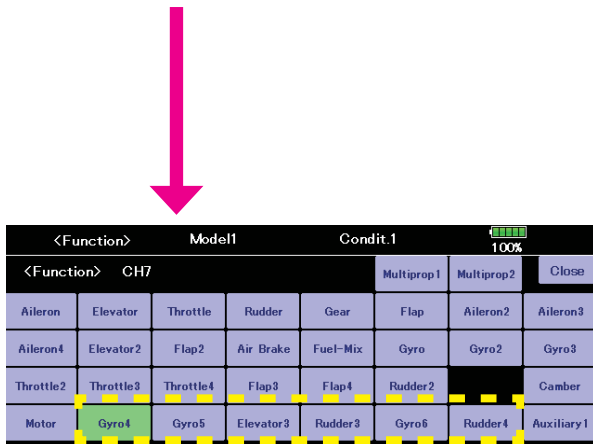

When Function button is tapped, the selection list of Functions are displayed. Please set and select the functions for Vector Nozzle.

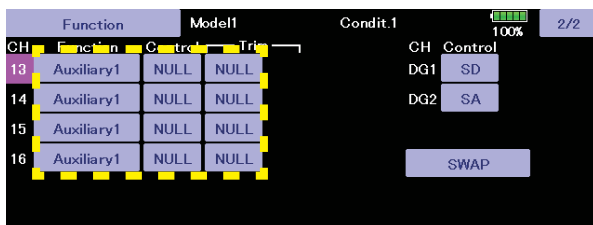

When Vector Nozzle button in ModelType menu is ACT, some functions regarding Vector Nozzle are displayed in Function list.

Set the control and trim hardware for Vector Nozzle pitch and yaw direction.

Usually, set them same as ELE and RUD control and trim.

The controls are set to the same default as the elevator/rudder controls. Trim is set to "--" by default.

### 3. Gyro settings screen

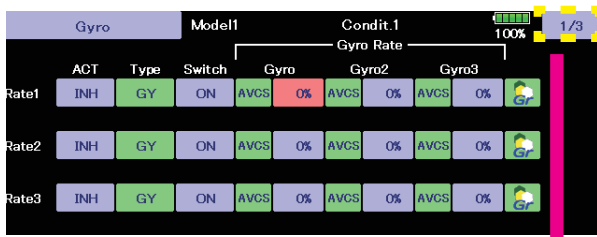

Page change button

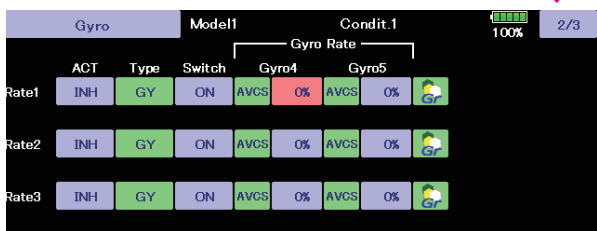

Page 2 is Vector Nozzel gyro setting page.

GYR4 and GYR5 settings are independent of GYRO, GYRO2, and GYRO3.

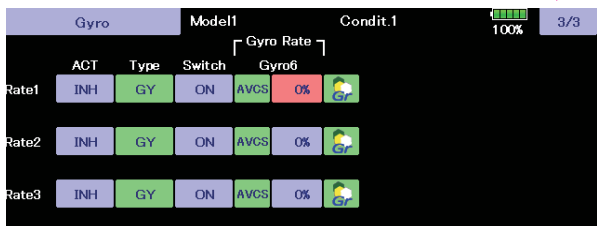

page 3, configure the gear (steering) gyro 6 settings.

## 4. Vector Nozzle setting screen

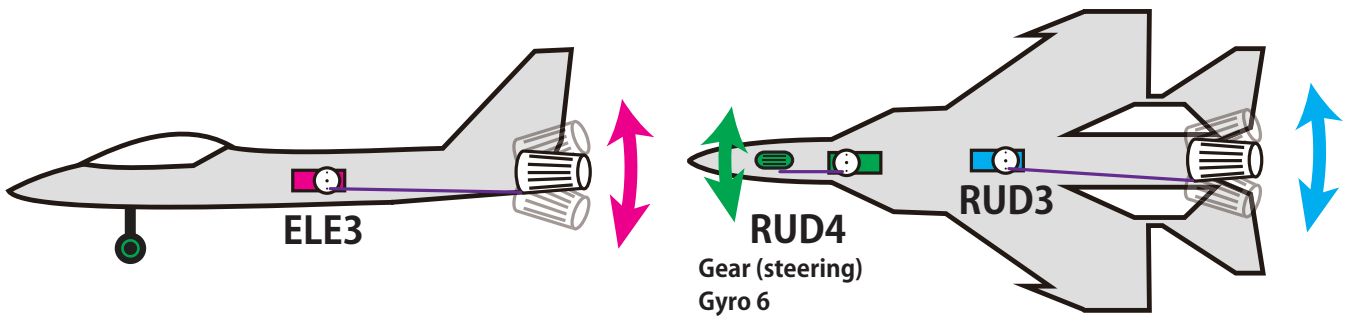

Vector Nozzle		Model1	Condit.1	100%	1/5
Gyro Direction					
ELE3	NORM				
RUD3	NORM				
RUD4	NORM				

- This sets the direction of ELE3 gyro.
- This sets the direction of RUD3 gyro.
- This sets the direction of RUD4 gyro.

Vector Nozzle		Model1	Condit.1	100%	2/5
Neutral Offset					
ELE3	+0				
RUD3	+0				
RUD4	+0				

- Neutral position adjustment of ELE3.
- Neutral position adjustment of RUD3.
- Neutral position adjustment of RUD4.

Vector Nozzle		Model1	Condit.1	100%	3/5
Servo Limit					
ELE3	100%	100%			
RUD3	100%	100%			
RUD4	100%	100%			

- Adjustment of maximum operating ELE3 servo position.
- Adjustment of maximum operating RUD3 servo position.
- Adjustment of maximum operating RUD4 servo position.

## 4. Vector Nozzle setting screen

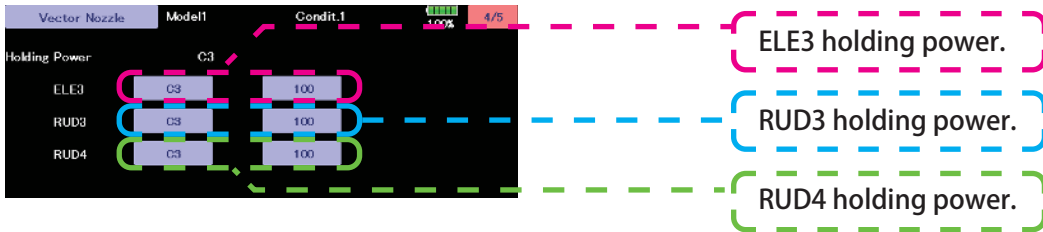

This adjusts the aircraft's attitude holding power when in AVCS mode. The smaller the value, the closer it is to normal mode. 5 rates, C1 to C5, can be set.

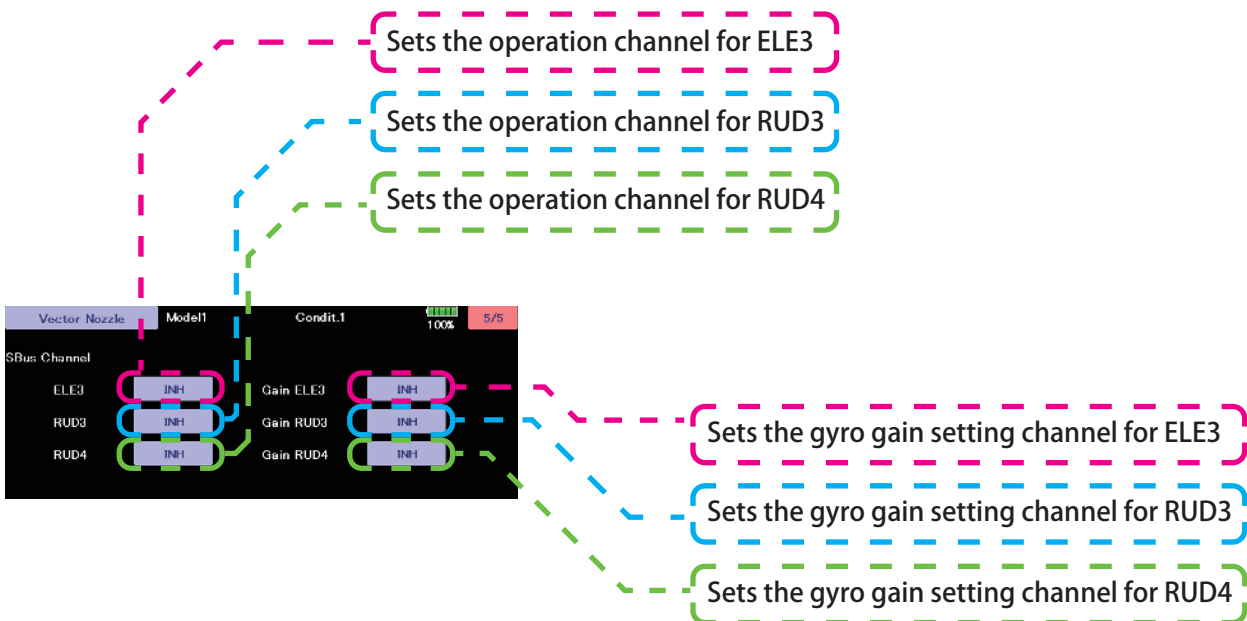

Example of connection one receiver and DLPH-2

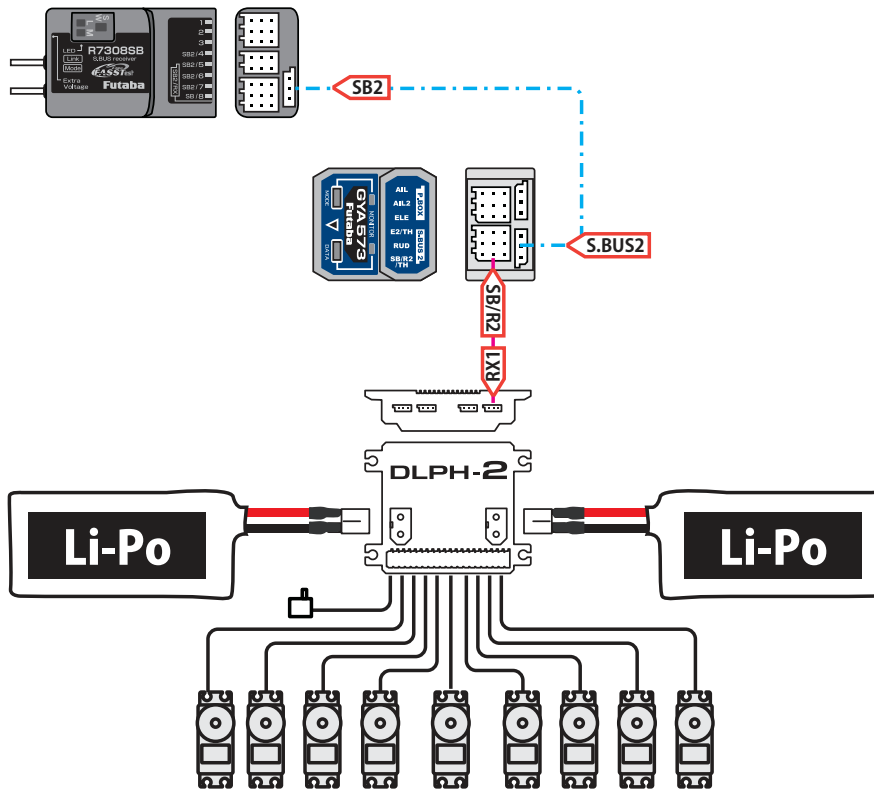

Example of connecting two receivers to the DLPH-2

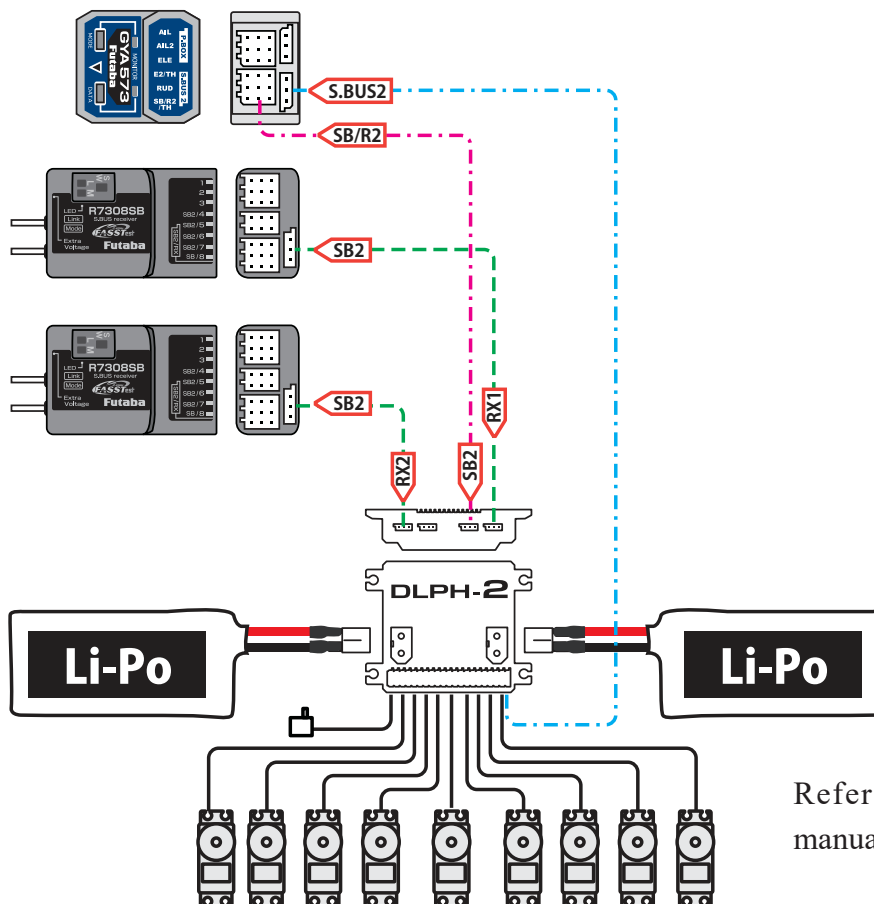

Refer to the DLPH-2 manual for details.

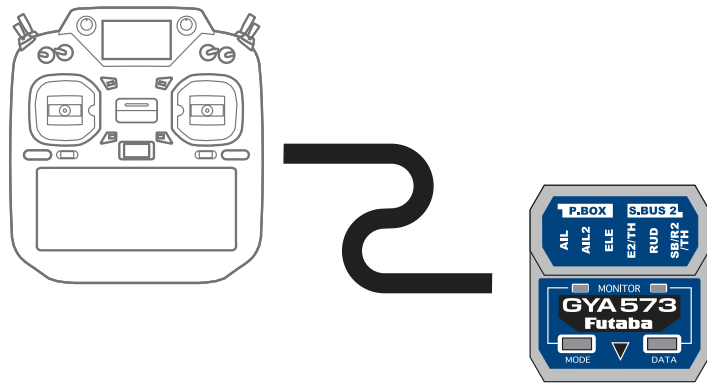

**Futaba**®